

SNS JOURNAL

/2024

Supported by the



SNS JOURNAL/2024

Grant Agreement N°: 101095811
Coordination and support action
Call Identifier: HORIZON-JU-SNS-2022-STREAM-CSA-01

SNS OPS - Supporting the SNS JU operations
SNS JOURNAL/2024



Table of Contents

Foreword from the Smart Networks and Services Joint Undertaking (SNS JU)	6
Introduction from the 6G Smart Networks and Services Industry Association (6G-IA).....	9
Ten key results.....	11
SNS, an innovative initiative to foster R&D	12
Projects' presentation.....	15

Call#1 Projects

Stream A-Smart communication components, systems, and networks for 5G Evolution systems

5G-STARDUST.....	18
6GREEN.....	20
BeGREEN	22
ACROSS.....	24
NANCY	26
SEASON.....	28
VERGE	30

Stream B-Research for radical technology advancement

6G-NTN	34
6G-SHINE.....	36
6GTANDEM.....	38
ADROIT6G	40
CENTRIC	42
CONFIDENTIAL6G	44
DESIRE6G.....	46
DETERMINISTIC6G.....	48
ETHER	50
FLEX-SCALE.....	52
HEXA-X-II	54
HORSE.....	56
PREDICT-6G	58
PRIVATEER.....	60
RIGOUROUS.....	62
SUPERIOT	64
TERA6G	66
TERRAMETA	68
TIMES	70

Stream C-SNS Enablers and Proof of Concepts (PoCs)

6G-BRICKS	74
6G-SANDBOX.....	76
6G-XR.....	78

Stream D-Large Scale Trials and Pilots with Verticals

FIDAL.....	82
IMAGINE-B5G	84
TARGET-X	86
TRIALSNET	88

Coordination Support Actions (CSAs)

SNS ICE.....	92
SNS OPS	94

Call#2 Projects

Stream B-Wireless Communication Technologies and signal processing

6G-CLOUD.....	100
6G INTENSE	102
6G-TWIN.....	104
EXIGENCE.....	106
ORIGAMI.....	108
6G-DISAC.....	112
6G-GOALS.....	114
6G-MUSICAL	116
6G-SENSES.....	118
INSTINCT	120
ISEE-6G.....	122
6G-EWOC.....	126
ECOeNET.....	128
OPTI-6G	130
PROTEUS-6G.....	132
iTRUST6G	136
NATWORK	138
ROBUST-6G	140
SAFE-6G.....	142
ELASTIC	144
6G-REFERENCE.....	148
FirstTo6G.....	150
TERAGREEN	152
6G-XCEL	156

Stream C-Complementary SNS experimental pan-EU federated infrastructure

SUNRISE-6G.....	160
-----------------	-----

Stream D-Large Scale Trials and Pilots with verticals-focused topic

6G-PATH.....	164
ENVELOPE	166

SNS Societal Challenges

6G4SOCIETY.....	170
-----------------	-----

SNS progress assessment

The SNS programme to date	174
Initial innovations and achievements	175
Vision	176
Cooperation and collaboration.....	177
Targeted use cases	178
SNS projects address industry challenges	179
Main recurring activities	181
Other 6G initiatives.....	188

Appendices

Working Groups.....	201
Acronyms and abbreviations.....	202

Foreword from the Smart Networks and Services Joint Undertaking (SNS JU)

2023 marked important milestones for the Smart Networks and Services Community and the Joint Undertaking. The European research and innovation programme towards a full 6G system has advanced to its second phase. The Smart Networks and Services Joint Undertaking (JU) became a financially autonomous EU body with continued commitment to deliver on Europe's ambitions with regard to technological advancement and leadership anchored on collaboration and partnership between the European Commission, the 6G Industry Association as well as national governments, international partners and a broad base of other key stakeholders.

Europe's objective is clear: leading the design and standardisation of 6G technologies, with a holistic industrial approach that focuses on connectivity but also tackles edge cloud environments and future chips for 6G.

European success in 6G will highly depend on the extent to which we succeed in building a solid 5G infrastructure, on which 6G technology experiments and, later, 6G deployments can build. The SNS JU reflects this rationale in its two-pillar approach, coordinating the 5G Strategic Deployment Agenda and for cross-border 5G deployment projects under the Connecting Europe Facility Digital and other programmes, while fostering Europe's technology and industrial capacities in 6G.

Until October 2023, when the SNS JU achieved the operational capacity to implement its own budget, it operated under the leadership of the committed Interim Executive Director, Peter Stuckmann and the Commission was responsible for the establishment and initial operation of the SNS JU. We thank him and the team for this!

2023 has been a year of growth for the SNS JU as the SNS JU team was strengthened by a new management team and officers, it launched the first wave of 35 projects, moved into its own office space and achieved financial autonomy.

Also in 2023, the SNS JU launched its second call, including the evaluation of more than 100 proposals. As a result, a portfolio of 28 additional research, innovation, and trial projects was selected, with an EU funding of around €132 million under Horizon Europe and the aim to build a first-class European supply chain for advanced 5G systems and Europe's 6G technology capacities.

These endeavours, spanning infrastructure deployment, research and innovation, are aligned with EU existing policies and societal needs, including competitiveness, supply chain resilience, sustainability, privacy, ethics, inclusion and cybersecurity.

Erzsébet Fitori,

*Executive Director of
the Smart Networks and
Services Joint Undertaking*



Looking at the challenges Europe currently faces in the rollout of future connectivity networks the recent White Paper of the European Commission on "*How to master Europe's digital infrastructure needs?*" foresees the fostering of a vibrant community of European innovators and advancing the development of integrated connectivity and collaborative computing infrastructures as some of the steps to take.

The SNS JU is at the forefront of this journey, as demonstrated by the current portfolio of 63 projects. This commitment underscores Europe's dedication to leading in the development of 6G ecosystems across domains like automotive, healthcare, Industry 4.0, and energy.

In 2024 our research cycle will further progress. Whilst the Call#2 projects have been launched as of January 2024, we are conducting the first reviews of Call#1 projects and look forward to completing the evaluation of proposals received for our third Call, towards the selection of a new set of cutting-edge 6G R&I projects within July.

Introduction from the 6G Smart Networks and Services Industry Association (6G-IA)

The SNS JU is moving ahead at full speed, 28 new Research and Innovation (R&I) projects have started in January 2024 as part of Phase 2 of SNS JU, complementing the 35 Phase 1 projects (operational since 2023) and bringing the total to 63 running projects. The combined work and outcomes of these projects, address a broad range of novel enabling technologies, KPIs and envisioned use cases. These use cases cover a diverse set of vertical fields and are expected to drive global 6G developments and deliver impactful European solutions for next generation networks and services.

As well as the total number of projects, an important aspect is the impressive participation of top European experts from varied backgrounds (industry, academia, RTOs, SMEs, etc.). This is proof of the significance of this endeavour for the European stakeholders and indicative of the impact it will potentially deliver. With 288 beneficiaries in Phase 1, another 222 beneficiaries in Call#2, and an SME participation of more than 20%, the SNS JU projects engage a broad and varied ecosystem of EU experts who have joined forces to deliver novel solutions that will realise the next generation of networks and services. The structured design of the SNS JU in Phases, and the constant monitoring and adaptation of the work programme, has allowed for an impressive range of technologies, enablers and use cases to be already addressed by

the 63 projects of the first 2 calls. Spearheaded by Hexa-X-II, which is the Flagship SNS JU project, the 63 projects cover all the key technological areas including the envisioned 6G Architecture, AI native solutions for RAN, core and cloud and novel devices and components, while addressing the needs of more than 11 different vertical sectors. This portfolio will be further enriched to tackle critical aspects via the 3rd call of the SNS JU call (set to close on April 2024) addressing the topics of the 2024 Work Programme, which includes two lighthouse projects on Sustainability and Micro-electronics.

As 2023 has marked the first year of the SNS JU with operational R&I projects, it is important to look back at the accomplishments and achievements of these projects during their 1st year, which are summarised in this journal. From the technological requirements analysis, use case definitions, architectural designs, to the early insights of the R&I projects. From the enlargement of the international and EU ecosystem of the SNS JU, to the monitoring and analysis of global 6G trends and innovative collaboration tools delivered by the Coordination and Support Action projects. They have all contributed to the successful start of Europe's 6G journey and to the establishment of strong foundation for further EU-based technological advancements.

Colin Willcock,

*Chairman of the Board
of the 6G-IA, Vice-Chairman
of the SNS JU, Vice-Chairman
of the ETSI Board.*



6G, the sixth generation of wireless technology, represents the next evolutionary step in telecommunications beyond 5G.

Although still in the conceptual and early research phases, 6G is envisioned to offer even faster data speeds, lower latency, and higher capacity compared to its predecessor.

Beyond simply improving upon existing technologies, 6G aims to revolutionise connectivity by enabling novel applications and services such as holographic communication, seamless virtual reality experiences, and ubiquitous AI integration.

Research into 6G encompasses a wide range of areas including advanced antenna technologies, THz frequency bands, quantum computing, and decentralised network architectures.

As the world becomes increasingly reliant on connectivity, 6G is expected to play a crucial role in shaping the future of communication and technology.

Ten key results

1. **Launch of Call#1 and #2 Smart Networks and Services (SNS) projects:** projects were launched in January 2023. Launch of Call#2 SNS projects: projects were launched early 2024.
2. **Standardisation:** With the standardisation framework designed in November 2023, workshops are being organised by ETSI leveraging the agreement signed in January 2023 with the 6G-IA.
3. **EuCNC 2023:** the event attracted more than 1,300 delegates from over 40 countries and more than 70 exhibitors in Gothenburg, Sweden in early June 2023.
4. **MWC 2024:** the “6G Horizon” session titled “Bridging Perspectives for a Sustainable Future” was hosted by the SNS JU.
5. **Cooperation between projects:** various workshops took place involving the cooperation of SNS projects such the 6G series.
6. **Global cooperation:** the 6G-IA inked 26 Memoranda of Understanding (MoUs) with similar programmes and peer organisations to strengthen collaboration between initiatives inside and outside Europe.
7. **Tools development:** Monitoring Framework, Verticals engagement tracker, replicability, and scalability tools.
8. **SME involvement:** there has been a sizeable increase in Small and Medium Enterprises’ (SMEs) participation in the SNS JU in a short time.
9. Increased activity for the **Smart Connectivity Digital Innovation Hub Network (SCoDIHNet) platform** and creation of the tool for assessing replicability and scalability.
10. **Sustainability and inclusion** addressed at the programme level and by projects, illustrated by the creation of the 6G-IA WiTaR (Women in Telecommunication and Research) Working Group (WG) and the introduction of Key Values (KVs) and Key Value Indicators (KVIs).

SNS, an innovative initiative to foster R&D

The SNS is a unique opportunity for the European Information and Communication Technology (ICT) industry to compete on the global market for 6G infrastructure deployment, operation, and services.

The SNS JU brings together industry leaders, academic institutions and policymakers to drive the development and deployment of cutting-edge technologies. By promoting collaboration and knowledge sharing among stakeholders, the SNS JU seeks to address key challenges facing the telecommunications sector, such as enhancing network performance, improving security and privacy, and enabling new applications and services. Through its strategic investments and initiatives, the SNS JU is instrumental in shaping the future of connectivity in Europe and beyond, driving economic growth, innovation, and societal progress.

THE SNS PROGRAMME AND ITS FIRST INNOVATIONS AND ACHIEVEMENTS

EU stakeholders' vision of 6G gave birth to the SNS JU programme, further shaped by contracted projects and the SNS JU community. This ongoing process involves engagement, technological innovation, and priority setting, deepening understanding and refining the vision for 6G. Mechanisms like the NetWorldEurope SRIA, 6G-IA's White Paper updates, and the SNS OPS Monitoring Framework have all spurred this evolution. Webinars, technical events, and community feedback loops contribute to the cyclic process, impacting future work programmes and guiding SNS JU initiatives. While the current focuses is chiefly technology research, there is a constant striving to enhance SNS Vision, with emphases on smart services, business models, and societal values. Collaboration with diverse stakeholders and broader community engagement is crucial to achieve comprehensive road mapping and addressing industry challenges. Further actions are recommended

across relevant WGs and activities to advance the vision and ensure holistic development.

The SNS programme that began in 2022 is organised into three main phases. The SNS programme and its related projects are already achieving outstanding progress and impact, step by step. Sixty three projects are contractually active (35 projects in Call#1 and 28 projects in Call#2) thus far, creating an extremely strong momentum and dynamism. An additional 16 projects are expected to be contracted from Call#3 (projects to start in January 2025).

The programme is moving forward with the creation and development of the Steering Committee (SC), Technology Board (TB), SNS and 6G-IA WGs and the SB Open Calls Task Force.

The programme is already extremely dynamic and buoyed by a tremendous momentum with cross-projects

workshops, projects' contributions to major international conferences including the ETSI Research Conference, EuCNC & 6GS 2023, Globe 5G Event, Globecom, 5G Techritory in 2023. Projects are also contributing actively to 2024 editions of these major events, including MWC 2024 and its SNS session and

20+ projects showcasing partners through organisations' booths and stands and EuCNC & 6GS 2024.

Other achievements include the SNS OPS Monitoring Framework launched in 2023 as well as the development of the SNS Verticals engagement tracker.

STANDARDISATION AND USE CASES

In November 2023, the International Telecommunication Union (ITU) published the framework for the development of standards and radio interface technologies for the sixth generation of mobile systems, commonly referred to as 6G. The IMT-2030 Framework Recommendation outlines six "usage scenarios", three evolving from IMT-2020 and three introducing new capabilities. It has also identified 15 capabilities for 6G technology, nine of which are derived from existing 5G systems.

The International Telecommunication Union Radiocommunication Sector (ITU-R) and initiatives such as Hexa-X-II are contributing significantly to this process by defining use case categories and scenarios that envision the transformative capabilities of 6G technology.

These use cases span across various sectors such as healthcare, transportation, manufacturing, entertainment, and public safety, illustrating 6G's potential to enable unprecedented applications and services. Expected usage scenarios for 6G include:

- Immersive communication to provide a rich and interactive video experience for users.

- Ultra-reliable and low-latency communication to enable the scale-up of intelligent industrial applications including telemedicine and energy and power grid management.

- Enhanced ubiquitous connectivity, especially in rural, remote and sparsely populated areas with the aim of bridging the digital divide.

- Massive communication to include expanded use of Internet of Things (IoT) devices and applications in smart cities, intelligent transport systems and sectors such as health, agriculture, energy and environmental monitoring.

- AI and communications to support AI-powered applications.

- Integrated multi-dimensional sensors to improve assisted navigation, and high-precision positioning including object and presence detection, localisation, imaging, and mapping.

These scenarios represent just a glimpse of the myriad possibilities that 6G networks promise to unlock, driving innovation, economic growth, and societal advancement on a global scale.

CHALLENGES OF THE INDUSTRY

Several critical challenges have emerged in recent years, at once societal, economic, sustainability and inclusion-related, requiring careful consideration and innovative solutions.

The industry is tackling critical societal and inclusion challenges, revolving around Key Value (KV) and Key Value Indicators (KVI), as well as key environmental and security challenges.

It is also grappling with cybersecurity issues due to constantly evolving cyber threats.

KVI/KVs

The SNS programme leverages the KVIs introduced by the 5G PPP programme as a way to gauge the connection to 6G and its influence on crucial societal values.

Sustainability

All of the SNS JU projects have also addressed the importance of sustainability in relation with the UN Sustainable Development Goals (SDGs), and make a distinction between Sustainable 6G – the

development and deployment of 6G technology with sustainability principles ingrained throughout its lifecycle – and 6G for Sustainability where ICT enables sustainability.

In addition, as cyber threats are constantly growing in both volume and sophistication, with their expanded attack surface and complex architectures 6G networks require robust defences. The issue was addressed at the *"6Gsec Common Path and Cardinal Points Conference"* in January 2024.

The 6G-IA WiTaR WG was recently created to address inclusion issues.

SME INVOLVEMENT AND SUCCESS STORIES

In 2023, SME participation in the SNS JU rose from 18% to 27% compared to 2022, exceeding the SNS JU's target of 20%. The

"European SME expertise in 5G and beyond 2023" brochure was released in February 2024.

SMART CONNECTIVITY DIGITAL INNOVATION HUB NETWORK (SCODIHNET) ACTIVITIES AND REPLICABILITY TOOL

Cooperation increased on projects such as CEF 5G for Smart Communities projects and through 66 African Digital Innovation Hubs (DIHs) in 20 countries.

A tool for assessing replicability and scalability has been designed and developed. It aims to provide a replicability level for use cases and solutions developed by smart connectivity projects.

Projects' presentation

In November 2021, the SNS JU was established as a legal and funding entity, one of the European Partnerships to step up the green and digital transition. It aims to facilitate and develop industrial leadership in Europe in 5G and 6G networks and services. This Partnership is jointly led by the European Commission and the 6G-IA.

The 6G-IA is the voice of European Industry and Research for next generation networks and services. The 6G-IA brings together a global industry community of telecoms & digital actors, such as operators, manufacturers, research institutes, universities, verticals, SMEs and ICT associations.

The SNS JU fosters alignment with Member States on 6G Research and Innovation and deployment of advanced 5G networks. The SNS JU sets out an ambitious mission with an EU budget of 900 million EUR for the period 2021–2027. The private sector will contribute with at least equal resources (i.e., 900 million EUR) to the SNS JU activities. The SNS JU funds projects that shape a solid research and innovation (R&I) roadmap and deployment agenda by engaging a critical mass of European stakeholders and facilitating international cooperation on various 6G initiatives.

As of 2024, 63 projects have been launched. The 35 first SNS JU projects corresponding to the first call for proposals were launched in January 2023 in four main complementary work streams. They include two CSAs (Coordination and Support Actions). They are critical in establishing a solid R&I foundation for Europe, defining the next-generation networks.

28 additional SNS JU projects corresponding to the second call for proposals were launched in January and March 2024 in three work streams, including one CSA.

On the 23rd of November 2023, the SNS JU adopted its SNS R&I Work Programme 2024, announcing EUR 129 million of EU funding for the Third Call to advance 6G Research in Europe and to develop test and pilot infrastructure capabilities. The third call opened on January 16, 2024, and closed in April 2024. Results will not be disclosed before the summer break 2024. 109 R&I proposals addressing the 3rd SNS JU call are currently under evaluation to select the next 16 SNS JU projects.

Call#1 Projects

The 35 SNS call#1 projects started in January 2023 with four streams and two Coordination Support Actions (CSAs).

Stream A

SMART COMMUNICATION COMPONENTS, SYSTEMS, AND NETWORKS FOR 5G EVOLUTION SYSTEMS

The seven projects in this stream trace an evolutionary path towards the development of 6G networks. The selected projects demonstrate complementarity and have been selected in such a way as to create a complete system view. Research topics covered include energy-efficient radio networks, adaptive Open RAN, integrated 5G-Non-Terrestrial Networks (NTN), AI-based edge platforms, and intelligent resource management ensuring security, privacy and trustworthiness.

5G-STAR DUST

5G-STAR DUST's ambition is to deliver a fully integrated 5G-NTN autonomous system with novel self-adapting end-to-end connectivity models for enabling ubiquitous radio access.

OVERVIEW

The 5G-STAR DUST project has been originated from the Stream A call O1-02 from the first SNS call in year 2022 and dealing with ubiquitous radio connectivity, whereby the main objective is to achieve seamless integration between terrestrial and non-terrestrial networks in a variety of scenarios by aligning to the existing 3GPP specifications from Rel 17 and Rel. 18. In particular, the main objective is to demonstrate the potentials of fully-regenerative non-terrestrial networks (mostly NGSO satellite systems) in a converged network ecosystem, whose unification is achieved by means of an affective self-organised network paradigm building on data-driven performance optimisation. To this end, a proof-of concept (PoC) targeting TRL4-5 is under design, which will integrate the

main components of terrestrial and non-terrestrial network with the main goal to show end-to-end connectivity for exemplary scenarios and the consequent candidate services, which are further outlined in the next sections.

The 5G-STAR DUST project is mostly aligning to the 5G-advanced wave of 3GPP standardisation path (i.e. Rel. 17-19), but supposed also to provide inputs to the following 6G standardisation phase starting with Rel. 20. As such, specific synergies have been already established with the other ongoing projects dealing with NTN, i.e. 6G-NTN and ETHER, with which joint dissemination events have been already organised (i.e. NTN workshop at EuCNC'23) and future ones are under preparation as well.

CONCEPT/ ARCHITECTURE

The underlying architecture builds on the concept of fully-softwarised self-organised network concept, hence allowing the integrated system to dynamically adapt to changing conditions of traffic and network topology, the latter being possibly resulting from satellite mobility. Then, the main innovation addressed in the project is the use of a fully-regenerative satellite architecture, which implements unprecedented onboard processing capabilities that go beyond what available nowadays in terms of local signal processing. In more detail, the objective is really to implement a full gNB in space and possibly also additional network functions (e.g. UPF) from the core network part in order to enable new services (e.g., edge computing in space) and in general to achieve a more flexible in-space network design.

In light of this, a special attention is devoted to the design of the space segment towards the allocation of the necessary network functions for the implementation of gNB onboard satellite. Under the assumption of a fully interconnected satellite network (i.e. neighbour satellites interconnected by means of inter-satellite links), the main concept exploited in the 5G-STAR DUST project is that all space nodes may embed a fully 5G/6G enabled payload, whose functionalities are however not always active and can stay idle for a certain time interval time. The reason for that relies on the fact that NGSO satellite illuminates for a large time of their daily orbit areas where there are no users, so that the corresponding 5G/6G functionalities can be switched off. On the other hand, as soon as the satellite is again offering service to the users in

the coverage area, the relevant network functions can be activated accordingly. Moreover, considering this architecture, it is also possible to think of a 5G

functional splitting achieved in space across neighbour satellite implementing different "parts" of a distributed gNB architecture.

USE CASES/ SCENARIOS

Based on the objective of providing ubiquitous wide-area wireless access, the 5G-STARDUST project has defined and selected five scenarios and use cases representing both unserved zones and vertical industry. Scenarios with seamless and transparent experience for end users have been prioritised among others, identifying key social challenges (KVI) and analysing new market opportunities. The selected use cases are shortly outlined in the following points:

- **Airway scenario:** Aimed at providing 5G services to the passengers thanks to multi-orbital solutions using GEO and NGSO satellites, working on FR2 bands, offering ubiquitous coverage across numerous geographies.
- **Residential broadband scenario:** Aimed at providing 5G connectivity

to residential users in underserved areas using dual GEO/LEO satellites operating in FR2.

- **Vehicle connected scenario:** Aimed at providing 5G connectivity to vehicles to give him services such as Software over the air (SOTA), HD maps and NG eCall service.
- **PPDR Scenario:** Aimed at providing backup connectivity access via satellite and temporary coverage for first responders and extended coverage in case of uncovered areas for first responder agencies.
- **Global private networks scenario:** Aimed at providing coordinated global connectivity with NGSO satellites so as to achieve distributed 5G systems for private networks.

FIRST RESULTS

The project has just entered the design & development phase of the elements composing the end-to-end connectivity chain, so that the first research and integration results will be available in the second half of year 2024. The general vision is in any case to come up with a TRL4/5 PoC able to show the advantages stemming from the integration of regenerative satellite systems the counterpart terrestrial networks to boost the performance of 5G-based services in scenarios where

the terrestrial connectivity alone will not suffice. In that respect, the evolution to 6G with more demanding service requirements will make this evolutionary path building on the integration of 6G and NTN an absolute need for fulfilling demands of society and industry verticals. Such a vision will be then substantiated by dedicated demonstration of the so-procured PoC and in terms of dissemination as well as standardisation actions within Rel. 19 of 3GPP.

Satellite And Terrestrial Access For Distributed, Ubiquitous And Smart Telecommunications



Coordinated by
Dr. Tomaso de Cola,
German Aerospace Centre (DLR)
January 2023–December 2025

Website: www.5g-stardust.eu

X: twitter.com/5G_stardust

LinkedIn: www.linkedin.com/company/5g-stardust/

Verticals concerned :

Automotive, transportation, residential broadband, PPDR, and governmental

Project Consortium Members:

Thales Alenia Space, Hispasat, Orange France, SRS, AW2S, Fraunhofer FOKUS, CTTC, CNIT, DLR, Martel



5G-STARDUST Architecture

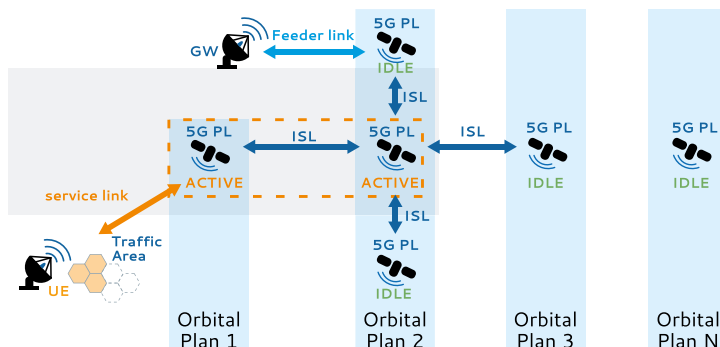

6GREEN

The 6Green project aims to create an innovative, service-based, and comprehensive ecosystem that promotes energy efficiency across the entire 5/6G value chain.

OVERVIEW

The ultimate objective of this project is to reduce the carbon footprint of 5/6G networks and vertical

applications. 6Green involves partners from 8 EU countries.

CONCEPT/ARCHITECTURE

6Green envisions the 5/6G ecosystem as a sustainable, interconnected, greener, flexible end-to-end intercompute system, able to properly interface stakeholders by means of latest generation intent-based and cloud-native paradigms, and facilitating their interactions according to green economy business models and agreements. This will enable 5/6G vertical applications and network slices to be dynamically, scalable, and autonomously placed in the edge-cloud continuum, instantiated, modified, migrated, and released in a coordinated fashion, when and where really needed by end-users to minimise the induced impact at the infrastructure layer.

The centrality of the SBA in the 5/6G ecosystem lies in its ability to engage with both the infrastructure and vertical application domains. This positioning makes it well-suited to collect metrics, making informed decisions, and facilitating backpressure propagation to other stakeholders. For this reason, 6Green is extending the currently specified 5G SBA Network Functions (NFs) to host the new features required for collecting

information, making decisions and actuating new configurations to the ecosystem in a way that involves all the stakeholders in the decision process.

The primary enabling technologies that will facilitate the realisation of the project's vision will be Artificial Intelligence, Cloud-native approaches, and the Edge-cloud continuum. These technologies will be integrated into an SBA composed of different frameworks that can interact synergistically to achieve the project's decarbonisation target.

The project targets highly innovative goals, such as the introduction of cross-domain mechanisms to map the energy ascribable to each stakeholder, allow them to dynamically renegotiate their service level agreements and gain incentives for embracing sustainable policies. The integration of new AI mechanisms in the 5/6G SBA is also a target of 6Green, to reduce the energy consumption/carbon footprint of both the network and the vertical applications dynamically and holistically, as well as exploiting renewable energy sources supplying the distributed infrastructure.

USE CASES/ SCENARIOS

UC #1: Critical Operation Maintenance during Energy-Constraint Disaster Scenarios,

focuses on maintaining operations in case several parts of the computing capabilities are unavailable (e.g., out of power, destroyed, sabotaged, etc.) or may become unavailable due to non-infinite power supply redundancy (e.g., electrical grid is offline, while local battery and solar powered backup is still available). In such a situation, certain functions need to be de-prioritised, moved to other execution resources, or even stopped, with the final goal of minimising consequences for the users.

UC #2: Energy-Efficient Augmented Reality Remote Assistance System,

aims to develop a Remote Visual Assistance application allowing to replace travel of expert technicians for advanced and

augmented remote collaboration and inspection tools, thus reducing travel costs and related CO2 emissions and time spent, as business trips account for a large share of the carbon footprint in many companies acting in any vertical market sector.

UC #3: Zero-Carbon Clientless Virtual Enterprise Desktop-as-a-Service (DaaS),

deals with remote Desktop as a Service (DaaS) solutions in a real cloud environment. Moreover, passing from the public cloud to 5/6G edge-cloud continuum, DaaS can benefit from 5/6G native security, slice integration with the private enterprise network infrastructure, etc. Therefore, it could become more than attractive for companies and a flexible means to efficiently support employees' smart working (and, therefore, to further reduce GHG emissions).

FIRST RESULTS

At the end of the first year, the design of the preliminary 6Green SBA has been completed, which builds upon the 3GPP specifications with additional features and even brand-new NFs. The goal is to act as a glue between the infrastructure and the vertical application domains, and be in charge of gathering metrics, making decisions and delivering them to the other stakeholders to propagate the backpressure.

At the time of writing, the definitions of the individual NFs and their main interactions has been completed; upcoming developments will include the refinement of the monitoring and profiling mechanisms, the design of the actuation policies at the network platform level, and of the management and exposure functionality to ensure that the actions are properly propagated across the whole ecosystem.

*Green Technologies
for 5/6G Service-Based
Architectures*



*Coordinated by
Roberto Bruschi (CNIT)*

January 2023–December 2025

Website: <https://www.6green.eu/>

X: twitter.com/6GreenProject

*LinkedIn: [www.linkedin.com/
company/6green-project/](https://www.linkedin.com/company/6green-project/)*

*Project Consortium Members:
CNIT, Ericsson, Telecom Italia, Athonet,
HPE, Consiglio Nazionale delle Ricerche,
Atos, Telefónica, Ubitech, Institute of
Communication and Computer Systems,
Eurecom, Smile, Telenor, Orange), Internet
Institute, Oculavis.*



BeGREEN

BeGREEN Brings Forward the Design of Energy-Efficient Solutions into Radio Access, Edge, Network Functions and Management.

OVERVIEW

BeGREEN brings forward the design of energy efficient solutions into the radio access, edge, network functions and network management by pursuing the following objectives: i) Planning and evaluation of a reference mMIMO architecture to achieve, Energy efficient connectivity; Proper spectrum resource allocation; Optimised resource allocation; Balance of energy transmission and interference mitigation; ii) 'DU/RU offloading engine' GPU based acceleration as a fundamental technology component to achieve energy efficiency for high computing offloading platform; iii) O-RAN based RU energy consumption optimisation; iv) Development of a sensing-assisted communication

usage optimisation; v) Design and development of an 'Intelligent Plane', incorporating O-RAN, along with user plane and data plane, for AI-assisted network function energy optimisation; vi) Design AI/ML algorithms that dynamically select CPU power saving modes (e.g., C-states) or adapt the number of active VNF instances to minimise energy consumption without affecting workload performance; vii) Design AI/ML algorithms that uses explainable and interpretable AI algorithms to accurately pinpoint energy influencing factors of the network functions beyond traffic; viii) Design and implementation of next generation Edge, aiming to minimise the overall energy cost.

CONCEPT/ARCHITECTURE

BeGREEN ORAN Intelligent Plane Architecture

BeGREEN proposed 'ORAN based Intelligent Plane' architecture is designed to support efficient, and AI assisted, energy efficiency enhancement and monitoring. The Intelligent Plane includes an AI Engine, the RICs, plus rApps and xApps. To better interface to other components and domains in the infrastructure, required interfaces are considered in the design. BeGREEN targets energy efficiency enhancements, in various domains, e.g., the RAN, including relays and RIS; the 5G core; and the Edge. The figure shows the overview of the architecture that leverages O-RAN Alliance baseline architecture and extends it by including the AI Engine to support the application of AI/ML. The services of the AI Engine will be exposed to the RICs and the rApps/xApps through additional interfaces not included in the O-RAN specification.

D4.1 provides further design principles of Intelligent Plane, ORAN based RAN Intelligent Controllers (RIC), and their utilisation for the implementation of intelligent and automated control loops, and related specifications, developments, and projects. It also covers the relationship of the BeGREEN Intelligent Plane with the rest of BeGREEN components and the O-RAN architecture.

BeGREEN Other Technology Enablers

BeGREEN team is using GPU for implementing Sphere Decoder algorithm for MIMO receivers. It is expected that the power consumption of the BeGREEN implementations will be reduced by at least 15% compared to legacy implementations.

BeGREEN works on developing ISAC algorithms to enable different approaches in improving energy efficiency of the radio network. Initially, optimisation



*Beyond 5G
Artificial
Intelligence
Assisted Energy
Efficient Open
Radio Access
Network*

Coordinated by Mir Ghoraiishi
(Gigasys Solutions)

January 2023- June 2025

Website: www.sns-begreen.com

X: @SNSBeGREEN

LinkedIn: www.linkedin.com/in/sns-begreen-project-613259250/

Project Consortium Members:
Accelleran, Gigasys Solutions, Innovations for High Performance Microelectronics, Telefónica I&D, BT, Ericsson LMI, Parallel Wireless, i2CAT, NEC Laboratories Europe, Universitat Politècnica de Catalunya, ARM Microprocessor, RunEL



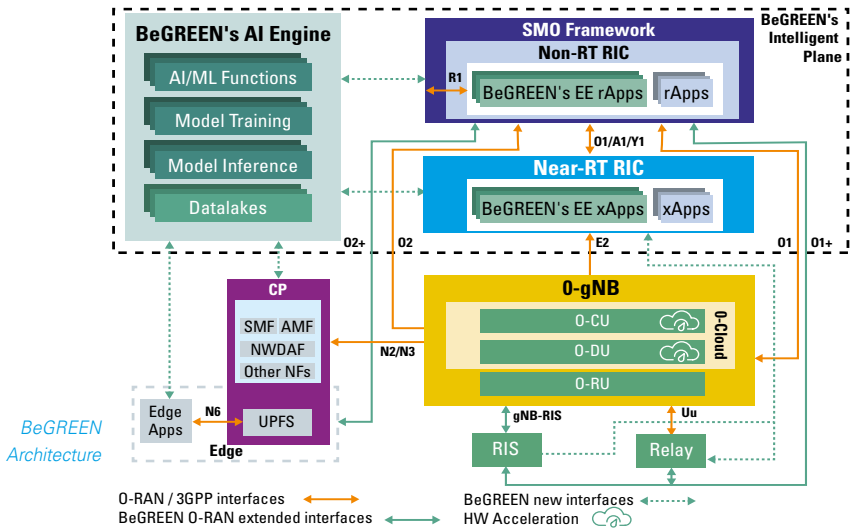

of the beam training algorithms, using sensing data from ISAC, are considered. Furthermore, BeGREEN investigates how ISAC can be used to provide spatial user density information to the network. It also works towards defining an ORAN-based architecture for supporting ISAC and RIS. In the context of relays, BeGREEN proposed a relay

activation function to smartly decide the activation and deactivation of relays by means of AI/ML techniques with the aim to improve the spectral efficiency and reduce the energy consumption.

D3.1 provides further information regarding BeGREEN approach on ISAC, RIS, and relays in energy efficiency improvement applications.

PROOFS OF CONCEPT

BeGREEN technologies will be showcased in three demonstrations. At IHP premises, the joint communications and sensing techniques toward efficient resource allocation and optimised power consumption. The project targets using RIS for energy saving scenarios in the demonstrations. Furthermore, two major project demonstrations

will be performed at BT premises in Adastral park. First, the 'Intelligent Plane' implemented using ORAN rApps and xApps will be demonstrated on a network emulator. Then, the project final integrated demonstrator using the Adastral testbed facilities to showcase BeGREEN technology innovations.

FIRST RESULTS

A summary of the initial results is as follows: i) BeGREEN reference architecture, the description of the proposed use cases and their specific requirements (D2.1) ii) Initial Definition of BeGREEN O-RAN Intelligent Plane, and AI/ML algorithms for NFV user-plane and Edge service control energy efficiency optimisation (D4.1) iii) An analysis of the strategies and functionalities that may be deployed at lower layers (L1 to L3) targeting energy efficiency enhancements to B5G systems (D3.1) iv) The scope and description of BeGREEN proof-of-concepts, and the related implementation and technology enablers integration plan

(D5.1) v) Furthermore, BeGREEN's initial results related to the project innovations, on ORAN based Intelligence Plane, Integrated Communications and Sensing and its integration with RIS, CU and DU hardware accelerations and results related to the novel energy saving algorithm called "PA Blanking". This latter scheme is on turning off the PA in the RU whenever there is no data transmitted from the RU (no user equipment in the coverage area) that reduces drastically the energy consumption of the RU especially at times when the network is not loaded with subscribers.

ACROSS

ACROSS offers a secure E2E network and service management platform for managing modern and future 6G services, addressing dynamicity, complexity, and scalability over an expanding cloud continuum.

OVERVIEW

Designing a future-proof service orchestration framework requires adhering to SOLID principles for clarity and coherence. The framework, ACROSS (Advanced Cross-Domain Orchestration System), is robust and adaptable, embodying iterative development and deep infrastructure visibility. It utilises a two-tiered orchestration architecture: domain orchestrators at edge sites coordinated by a cloud-managed multi-domain orchestrator. An

“ultra-sensing” telemetry infrastructure and “ultra-instinct” AI layer automate decision-making. ACROSS offers programmable “hooks” for zero-touch operations and prioritises security measures against potential threats. Validation is through comprehensive test cases across various sectors, ensuring efficacy, and adoption is enhanced through engagement in standardisation and open-source activities, showcasing its market potential.

CONCEPT/ARCHITECTURE

ACROSS proposes a multi-layered architecture that facilitates the orchestration of network resources and services across different domains, including access, core, edge, and cloud. This architecture enables seamless integration and coordination of management functions, allowing for efficient resource allocation, optimisation, and provisioning.

The project leverages various technologies to realise its objectives, including:

Artificial Intelligence (AI) and Machine Learning (ML): AI-driven predictive analytics and automation enable proactive management of network resources, predictive maintenance, and optimisation of service delivery.

Zero-Touch Provisioning (ZTP): ZTP streamlines the deployment and configuration of network elements and services, reducing manual intervention and minimising deployment time.

Software-Defined Networking (SDN) and Network Function Virtualisation (NFV): SDN and NFV technologies enable dynamic and flexible network provisioning, allowing for the virtualisation of network functions and the creation of service chains.

Telemetry and Monitoring: Real-time monitoring and telemetry provide insights into network performance, traffic patterns, and resource utilisation, facilitating intelligent decision-making and adaptive management.

ACROSS introduces several innovations to address key challenges in network management and orchestration, including:

AI-driven Predictive Lifecycle Actions: Utilising AI and ML algorithms to predict and preemptively address network issues, optimise resource utilisation, and enhance service reliability and quality.

Integrated End-to-End Orchestration Flow: Establishing seamless orchestration workflows that span multiple domains, enabling holistic management of network resources and services from edge to core.

Vertical-specific Applications: Tailoring network management solutions to meet the unique requirements of vertical industries such as smart cities, industrial automation, health-care, and agriculture, facilitating the deployment of customised services and applications.

USE CASES/ SCENARIOS

TC1: Stakeholder-driven zero-touch orchestration exercises the ability of the ACROSS platform to realise events coming from the overlay stakeholders through the ACROSS Northbound Interfaces (NBIs). The ACROSS orchestrators work in par with zero-touch provisioning mechanisms to fully-automate a large variety of important and frequently appearing northbound-driven policies/operations.

TC2: Device-driven zero-touch orchestration aims to construct a highly responsive orchestration engine equipped with advanced sensing features. The goal is to autonomously convert events from both infrastructure and end-user devices into a sequence of automated,

zero-touch actions. These actions will swiftly adjust the overlay platform and its services to adapt to constantly shifting conditions.

TC3: Intelligence-driven zero-touch orchestration will create a truly unsupervised intelligence for autonomously and proactively convert network telemetry events into intelligent, actionable zero-touch service orchestration decisions.

TC4: Holistic zero-touch orchestration. This test case culminates the ACROSS automation capabilities by demonstrating the necessary mechanisms that allow zero-touch operations to be chained together, forming composite and often complex orchestration tasks.

FIRST RESULTS

The project's results thus far comprise thorough exploration and conceptualisation of the ACROSS platform, culminating in the definition of its ecosystem, essential requirements, and diverse usage scenarios. We meticulously mapped out the platform's ecosystem, clarifying its architectural components and interaction mechanisms to enhance understanding of its operational landscape. Concurrently, we identified key stakeholders and their roles, establishing the groundwork for collaborative development

and successful platform deployment. Furthermore, our analysis extended to scrutinising technical dimensions and requirements, ensuring alignment with strategic objectives and contributing to standards and open-source initiatives. This comprehensive approach not only outlines a roadmap for collaboration and integration but also presents a holistic vision for the ACROSS platform's development trajectory, ensuring its efficacy and relevance across various domains and applications.

Automated zero-touch cross-layer provisioning framework for 5G and beyond vertical services



Coordinated by
Ioannis Markopoulos (NOVA)

January 2023–December 2025

Website: across-he.eu

X: twitter.com/horizon_across

LinkedIn: www.linkedin.com/company/across-horizon-europe/

Project Consortium Members:
NOVA, Ericsson, NEC, Telefonica, CTTC,
University of Patras, Polytechnic University
of Madrid, UBITECH,
K3Y, Inelcom
Commercial Pathways,
WINGS-ICT



NANCY

Focusing on energy-efficient wireless networks, adaptive Open Radio Access Networks, AI-based edge platforms, and intelligent resource management ensuring security, privacy, and trustworthiness.

OVERVIEW

The future beyond 5th generation (B5G) and 6th generation (6G) wireless networks will introduce new technologies, including higher frequency bands, denser networks, virtualisation and orchestration, and principles that aim to enhance scalability, flexibility, and resource management resulting in complex and diverse networks. However, without coordination and cooperation among mobile network operators, there can be duplication, redundancy, and inefficiency in data provisioning. Many currently deployed access points are not being utilised

to their potential, reducing the consumers' quality of service and experience. This emphasises the need for a network architecture that integrates different service providers and consumers, thereby revolutionising the radio access paradigm. The NANCY project envisages introducing a secure and intelligent architecture for next-generation wireless networks. By leveraging Blockchain and artificial intelligence (AI), NANCY will design flexible networking schemes, as well as secure and intelligent resource management mechanisms.

CONCEPT/ARCHITECTURE

The high-level architecture of NANCY (see figure) consists of the three following planes:

The **cloud plane**, with computing, caching, and processing capabilities, facilitates proactive network operations through advanced functionalities such as data mining and big data. Furthermore, it aims to predict events, allocate resources in advance, and enable cloud servers to handle applications with flexible time requirements and store large or less popular content. Also, the integration of the Blockchain manages security parameters and keys for all entities involved.

The **edge plane** combines edge servers and the Blockchain toolbox to provide radio interfaces for devices, ensuring seamless coverage. The edge servers possess caching capabilities and AI functionalities that allow them to smartly distribute computational tasks and cache applications that require intensive processing or low

latency. The Blockchain maintains a distributed ledger to ensure security and privacy within the wireless ecosystem. Additionally, spectrum sharing among providers, resource allocation for computation/caching purposes, energy management, and storage optimisation enable the dynamic orchestration of resources and services.

In the **user plane**, the end user and service provider sign the service level agreement (SLA) through the blockchain digital signatures used for authorisation. The SLA is verified through the mining process and the verified smart contracts are combined into a block and added to the blockchain. As a result, the end user gains access to spectrum assets and automatically compensates the service provider accordingly. B-RAN safeguards both end users' interests and service providers' rights, thereby fostering trust between previously untrusted parties.

an artificial INtelligent Aided unified Network for seCure BeYond 5G long term evolution



Coordinated by
Prof. Panagiotis Sarigiannidis
(University of Western Macedonia)

January 2023–December 2025

Website: <https://nancy-project.eu/>

X: twitter.com/project_nancy

LinkedIn: www.linkedin.com/in/nancy-sns-project-5342ab263/

Verticals concerned:

Automotive, transport and logistics, media and entertainment

Project Consortium Members:

UOWM, UBITECH, TECNALIA, NEC Germany, i2CAT, ITL, INTRA, 8bells, TDIS, DRAXIS, OTE, VOS, IJS, CRAT, TEI, BI2S, INNO, CERTH, SID, UMU, SSS, MINDS.



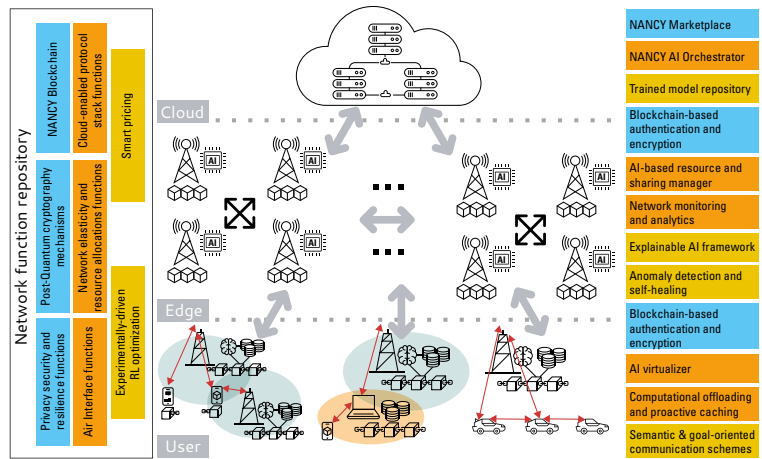

USE CASES/ SCENARIOS

NANCY envisions freeing the role of the network nodes and allowing them to interchangeably be connectivity/service consumers and providers. In this respect, the following usage scenarios are investigated.

1. Fronthaul network of fixed topology: In this scenario, each device performs a computation-intensive and delay-sensitive task, such as navigation, video streaming, etc., considering that the access points belonging to the same or different providers are equipped with edge computing capabilities; thus, having high availability of computation resources and executing AI functions. Resource-limited mobile devices can offload their tasks to the heterogeneous edge infrastructures, which utilise fine-grained computational resource allocation policies to process the offloaded tasks.

2. Advanced coverage expansion: The concept of advanced coverage expansion aims to address the ever-increasing demand for reliable, high-speed connectivity in diverse environments. This approach leverages innovative techniques, such as relaying, dynamic topologies, and efficient connectivity to enhance network performance. These strategies not only ensure broader and more robust network coverage but also improve energy efficiency.

3. Advanced connectivity of mobile nodes: This scenario supports vehicle-to-access point and vehicle-to-vehicle communication. Content is shared between vehicles with one vehicle acting as a relay to forward traffic to an access point. Since vehicles may not trust each other, they need to use blockchain pseudonyms when sharing data to increase security and privacy.

FIRST RESULTS

NANCY addresses key gaps in current 6G architectures by establishing a groundbreaking framework that integrates blockchain technologies and AI to enhance network security, efficiency, and intelligence. Performance analysis and targeted Key Performance Indicators and Key Value Indicators will be the key features to optimise intelligent resource management, flexible networking, and orchestration effectively. In the network design domain, NANCY targets the development of novel architectures such as point-to-point connectivity for device-to-device connectivity, mesh networking, and

relay-based communications, as well as protocols for medium access, mobility management, and resource allocation.

The analysis of the existing 5G and 6G state of the art, alongside the integration of insights from both 5GPP and non-5GPP projects, will ensure that NANCY remains at the forefront of technological innovation. Having as a starting point the reference use cases that led to the evolution and an overview of the relevant use cases, NANCY's usage scenarios are considered the cornerstone of almost all the 6G SNS-described verticals.

SEASON

An innovative Multi-Band over Space Division Multiplexing (SDM) optical network infrastructure, spanning the access, aggregation, and metro/long-haul segments.

OVERVIEW

The SEASON project is developing an innovative Multi-Band over Space Division Multiplexing (SDM) optical network infrastructure, spanning the access, aggregation, and metro/long-haul segments. SEASON provides novel transmission, switching, monitoring and AI-driven control solutions, supporting the requirements for x-haul in terms of capacity and energy efficiency. The SEASON consortium includes major European telecom operators, major vendors, three consolidated, Wings and WestAquila) and four top-reputed research centres and academic institutes.

SEASON, together with other relevant SNS projects focusing on optical networks (e.g., FLEX-SCALE), has a clear impact on the society and emerging services, being capable of scaling up network capacity and coping with challenging user needs through improved power efficiency, reliability, and self-management capabilities. New emerging services such as Augmented Reality (AR) pose stringent requirements in terms of reliability, connectivity and capacity. The figure below displays the overall SEASON solution and its main innovations and technology pillars.

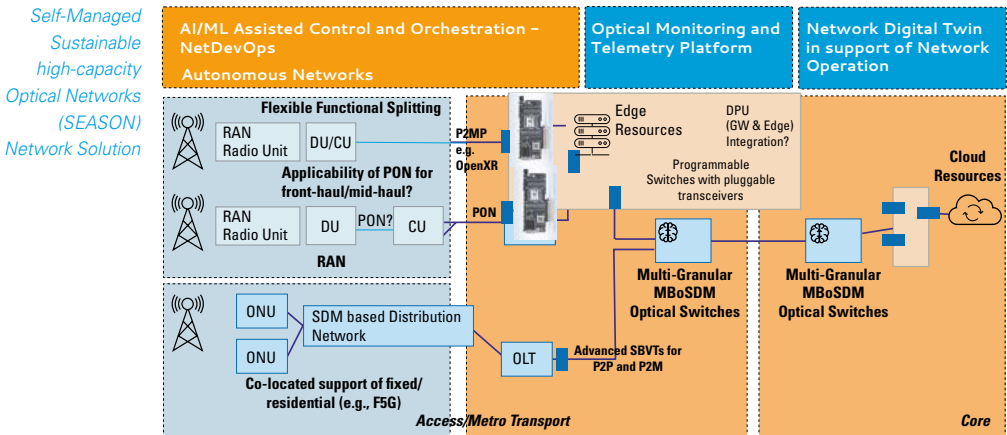

CONCEPT/ ARCHITECTURE

The SEASON architecture targets innovative transmission and switching solutions operating on Multi Band (MB) over Space Division Multiplexing (MBoSDM). Data plane innovations include multi-granular MB/SDM switching nodes, advanced Digital Signal Processing (DSP), and sliceable Bandwidth Variable Transceivers (S-BVTs) enabling both point-to-point (P2P) and

Point-to-MultiPoint (P2MP) connectivity. Furthermore, SEASON addresses the convergence of optical, packet and computing resources by incorporating coherent pluggable transceivers within the latest generation of Data Processing Units (DPU). The architecture's crucial objective is to ensure energy efficiency and reduce the number of Optical to Electrical to Optical (O/E/O) conversions.

The complex infrastructure prompts a reconsideration of control and orchestration systems towards autonomous optical networks. This involves integrating RAN, access, and transport segments into overarching control systems and adopting agile DevOps methodologies. SEASON develops cognitive networks powered by streaming telemetry, real-time network measurements,

and AI/ML-aided service management and orchestration for near-real-time network operation. This involves developing multi-objective techniques to optimise resource allocation and service functionality. Intelligence is moved as close as possible to the data plane, employing a distributed system based on multiple communicating agents and data-driven closed control loops.

USE CASES/ SCENARIOS

SEASON addresses two main use cases/scenarios. The first one focuses on the network perspective, showing how the SEASON solution enables a network Operator to provide an innovative end-to-end infrastructure with capacity scaling, monitoring and

AI/ML network operation in support of beyond 5G.

The second use case provides the user perspective considering challenging Augmented Reality applications for user-driven immersive experiences.

FIRST RESULTS

Work during the project's first year was devoted to detailing the SEASON architecture. This reference architecture makes use of innovative technologies developed within the project including: i) disaggregation of optical platforms using "white box" optical nodes and new generation dedicated coherent pluggables; ii) SmartNIC and Data Processing Units (DPUs) with coherent Pluggable; iii) P2MP transponders; iv) MBoSDM node and network capabilities; v) innovative SDM PON and F/M-haul solutions; vi) overarching end to end AI/ML

empowered control and management planes fed with vii) pervasive telemetry. The proposed design is shown in the figure below.

The innovative MBoSDM concept is capable of providing x120 capacity increase compared to current C-band solutions, while the employed (L2/L3) white box comprises switches with up to 32 100G/400G QSFP-DD (1.6-3.2 Tbps) pluggable transceivers. Different node architectures should be used in each network segment because of the dissimilar requirements of each part.

Self-Managed Sustainable high-capacity Optical Networks



Coordinated by Filippo Cugini (CNIT)
 January 2023–December 2025
 Website: www.season-project.eu/
 X: twitter.com/HorizonSeason
 LinkedIn: www.linkedin.com/company/horizon-sns-season/

Verticals concerned: Augmented reality (AR) service for user-driven immersive experiences

Project Consortium Members: Telefonica, TIM, Adtran, Infinera P/G, Ericsson, Accelleran, WINGS-ICT and WestAquila, CNIT, CTTC, Fraunhofer HHI, UPC.



Overall high-level view of the SEASON architecture for the long-term

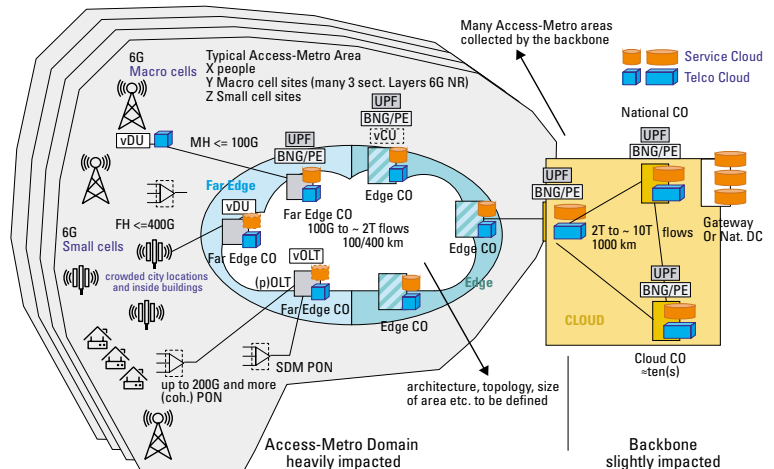

VERGE

The EU-funded research project VERGE aims to deliver an AI-empowered, flexible and modular edge platform, unifying communication and computation resources into an edge-cloud compute continuum that is seamlessly integrated within B5G.

OVERVIEW

VERGE is bringing forth an evolved design for the edge computing architecture in Beyond 5G (B5G) networks. It targets the seamless execution of cloud-native services, including disaggregated Radio Access Network

(RAN) and core network functions, distributed AI and big data workflows, while leveraging data-driven, intelligent solutions for edge and network optimisation.

CONCEPT/ARCHITECTURE

VERGE has proposed an initial edge computing architecture (see figure), for the creation of an integrated B5G-enabled multi-site edge-cloud compute continuum. It is built around three main pillars:

1. **"Edge for AI"** (Edge4AI), a flexible, modular and converged edge platform design that unifies the lifecycle management (LCM) and closed-loop automation for cloud-native applications and network services across a unified edge-cloud compute continuum.
2. **"AI for Edge"** (AI4Edge), a portfolio of AI-based solutions to manage and orchestrate the computing and network resources.

3. **"Security, Privacy and Trustworthiness for AI"** (SPT4AI), a suite of methods to ensure the privacy of sensitive data and AI models, the security of these models against adversarial attacks, their safe training and execution, and their explainability.

VERGE innovations are around AI-enabled orchestration of services and network elements, distributed and split computing, AI-driven network slicing, relay-enhanced edge optimisation, distributed learning, and several aspects of AI.

USE CASE/SCENARIOS

VERGE use cases target two vertical domains:

1. **XR-enabled industrial use case.** This will focus on delivering immersive XR services with minimal latency and overall high Quality of Experience (QoE) to enable and improve industrial processes, such as the collaborative product design and prototyping by remote engineering teams and the XR-aided remote robotic control.

2. **Autonomous tram use case.** The focus is on the use of safety services running on-board an autonomous tram and at the edge infrastructure and fusing the input of multiple sensors (e.g., cameras, Lidars, radars, etc.) to augment the situational awareness of the driver by detecting hazardous situations across the tram path.

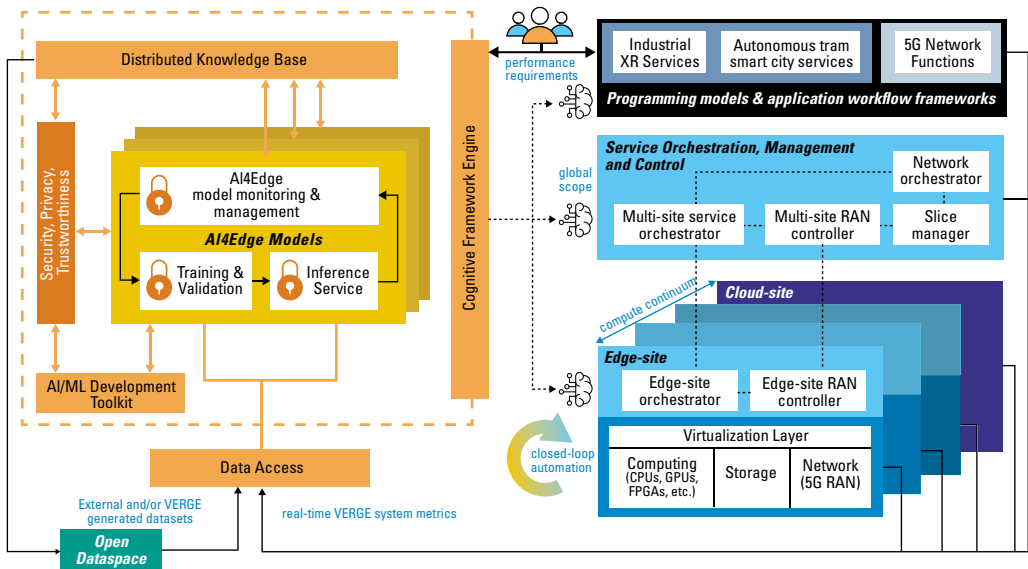

FIRST/EXPECTED RESULTS

The first version of Edge4AI, AI4Edge and SPT4AI pillars has been delivered. The key features of the Edge4AI are:

1. Support for programming models and frameworks from the embedded, High Performance Computing (HPC) and AI domains. These leverage parallelism and reconfiguration capabilities of heterogeneous accelerated architectures (GPUs, FPGAs, etc.) to support different levels of distributed computation.
2. A hierarchical service orchestration, management and control layer that supports different levels of granularity, i.e., across multiple edge sites, within an edge cluster, and at task level.
3. Support for close-loop automation, through the data access layer, which handles the collection of relevant metrics, and the cognitive framework, which provides the open APIs and services to facilitate the LCM of AI/ML models.

In AI4Edge, different cutting-edge AI techniques have been developed, including:

1. Edge resource management solutions for dynamically and/or proactively optimising computational resource

allocation (e.g., CPU rightsizing and autoscaling).

2. Advanced learning solutions for heterogeneous edge environments, including federated and collaborative learning, and split learning to off-loading part of complex deep neural networks from the UEs to the edge.
3. RAN management solutions for edge-enabled relay management, network slicing, multi-tier RAN optimisation, dynamic functional split and micro-orchestration of RAN functions.
4. E2E AI orchestration for collision-free decision-making.

In SPT4AI pillar, the studied methodologies include:

1. Security and privacy issues through threat analysis and mitigation measures, and tackling vulnerabilities arising e.g., in distributed MIMO.
2. Resilience and robustness of AI models in decentralised edge deployments against attacks that compromise the quality of training data.
3. Solutions for the generalisation, formal verification, safe deployment and training, and explainability of AI models.

AI-powered eVolution towards opEn and secuRE edGe architEctures



Coordinated by Oriol Sallent (Universitat Politècnica de Catalunya)

January 2023–June 2025
 Website: www.verge-project.eu/
 X: twitter.com/verge_project
 LinkedIn: www.linkedin.com/company/verge-snsproject/

Verticals concerned : Smart manufacturing and industry Smart and sustainable transportation

Project Consortium Members: Polytechnic University of Catalonia BarcelonaTech, CTTC, King's College of London, University of Oulu, University of Siena, Barcelona Supercomputing Center, Samsung, Intel, Ericsson, Turkcell, Nearby Computing, hiro Microdatacenters, Thalès, Aercelik, Holo-Light



Stream B

RESEARCH FOR RADICAL TECHNOLOGY ADVANCEMENT

(in preparation for 6G
and radical advancements
of IoT, devices and software).

The focus of Stream B is on novel technologies that are expected to be adopted in commercial networks within a mid- and/or long-term timeframe. Research topics considered in the 19 retained projects include, inter alia, novel 6G system architectures, advanced wireless and optical communication technologies, advances in Non-Terrestrial Networks, secure development of URLLC applications.

6G-NTN

The 6G-NTN project brings together high-level representatives from the mobile communication, satellite, and research communities to identify technical, regulatory, and standardisation enablers for the NTN component of 6G.

OVERVIEW

6G-NTN's ambition is to research and develop innovative technical, regulatory, and standardisation enablers to ensure the full-fledged integration of the NTN component into the 6G system to meet the vertical industries' needs and consumer market expectations. The project is carrying out multiple R&D activities aimed at achieving specific outcomes that will pave the way for a service roll-out in the 2030–2035 timeframe. These outcomes include: a sustainable and resilient 3D multi-layered network architecture; a software-defined payload adapted to all orbits and spectrum; a very

low Earth orbiting space segment; a flexible waveform supporting TN and NTN deployments; the support of smartphones and small-factor vehicle/drone-mounted terminals (with a prime focus on antenna solutions); the use of new spectrum (i.e., C and Q/V bands) in coexistence with the TN component; and a high accuracy and reliable positioning solution. By achieving its objectives and promoting uptake of its results, the project will make a significant contribution to strengthening Europe's industrial leadership in wireless communications and services infrastructure.

CONCEPT/ARCHITECTURE

6G-NTN is dedicated to enhancing the air-interface optimisation for NTN, with a focus on several key features. These include ensuring compatibility with TN, facilitating spectrum sharing, resilience to co-channel interference, support for User Equipment (UE) without a Global Navigation Satellite System (GNSS), and reducing computational complexity.

The development of AI-based network functions is central to 6G-NTN's approach. These functions empower

the network to make intelligent decisions regarding throughput capacity utilisation, spectrum management, and interference mitigation. Through innovative radio resource management strategies, 6G-NTN addresses challenges such as cell load balancing, fractional frequency reuse, traffic prediction, and link quality forecasting. These advancements equip the network with the capabilities needed to overcome obstacles associated with NTN deployment and operation.

USE CASES/SCENARIOS

6G-NTN use cases (UC) were elaborated with the objective to select realistic, viable and credible scenarios, in which current and mid-term technologies would find their limitations in supporting the features exhibited by these deliverable UCs.

The project identified seven UC: maritime coverage (UC1), drone connectivity for inspection and urban air mobility (UC2 and UC3), public protection and disaster relief (UC4), consumer handheld connectivity (UC5), seamless connectivity in high mobility (UC6), direct communications over satellites

(UC7), i.e., without requiring a feeder link connection between the satellite(s) and the ground station(s).

A preliminary analysis¹ (described in deliverable D2.3) has been carried out highlighting that the 3D multi-layered

¹ Described in D2.3, <https://www.6g-ntn.eu/public-deliverables/>

network infrastructure, the seamless and transparent connectivity, and the performance increase were relevant features to be provided by 6G-NTN. As the proposed scenarios use such enablers in different ways, special care will be taken when further investigating those aspects in the remainder of the project.

FIRST RESULTS

6G-NTN aims to establish a fully integrated, multi-dimensional, and multi-layered network that unifies both TN and NTN infrastructures. In this context, Deliverable D3.1 outlines the preliminary design of the network, featuring a three-layer architecture comprising of HAPs serving as opportunistic and flexible nodes to enhance local capacity and coverage. Two Low Earth Orbit constellations operating at altitudes between 400 and 800 km, along with an overlay layer consisting of 3 GEO satellites, have been selected. The nodes are equipped with flexible, software-defined payloads across various flying platforms and frequency bands, with the objective of supporting functional splits between onboard/onboard and onboard/ground network elements as well as horizontal and vertical inter nodes links.

In terms of frequency bands, 6G-NTN focuses on utilising the C band for direct connectivity to smartphones and the Q/V band for high-directivity terminals, such as VSATs, and for the feeder links. The introduction of these new frequency bands prompted an analysis of coexistence scenarios between NTN and TN in-band and adjacent-band operations, which can be found in Deliverable D4.4, along with parameters for NTN User Equipment (UE), TN Base Stations (BS) and UE, and the NTN satellite network.

On the user side, an important outcome will be the development of low-cost, size, weight, and power NTN user terminals. Two types of terminals are considered: i) smartphone upgraded to support the C band; and ii) vehicle/drone mounted ultra-small aperture terminals able to operate simultaneously with both NTN access in C band and Q/V bands.

The project is also working towards the design of a flexible air interface capable of addressing the requirements of TN and NTN components. This air interface is expected to ensure compatibility with TNs, provide additional link margin for light indoor communications, and GNSS free operation. At the same time, activities are addressing the design and development of dynamic orchestration of Virtual Network Functions in a 3D network for 6G.

Finally, 6G-NTN is developing an accurate and reliable positioning service by enhancing the reliability of the system architecture at both the User Equipment (UE) and Radio Access Network (RAN) sides in the space-based components, and by refining the pilot schemes and reference signals within the identified air interface.

6G Non-Terrestrial Networks



Coordinated by
Alessandro Vanelli-Coralli
(Unibo)

January 2023–December 2025

Website: www.6g-ntn.eu/

X: twitter.com/6Gntn

LinkedIn: www.linkedin.com/company/6g-ntn/

Verticals concerned:
Maritime, Automotive, Transportation,
Public Protection and Disaster Relief,
Direct Communication over Satellites

Project Consortium Members:
University of Bologna, Thales Alenia Space
France and UK, Martel, Telit Cinterion,
Greener Wave, Thales Six, CTTC, Ericsson
Sweden and France, CTTC, DLR's Institute
of Communications and Navigation,
Orange, SES Techcom, Qualcomm
Communications France, Digital For Planet.



6G-SHINE

The 6G-SHINE project will pioneer the main technology components for wireless in-X subnetworks, short range low-power radio cells to be installed in industrial, vehicular and consumer entities.

OVERVIEW

6G-SHINE aims at designing the main technology components for wireless in-X subnetworks, short-range low power radio cells located at the very end of the 6G 'network of networks', to provide pervasive wireless coverage

with unprecedented performance requirements. 6G-SHINE is a low TRL project (2-4), and the research covers elements of physical layer, medium access control, radio resource management, and network architecture.

CONCEPT/ARCHITECTURE

The main areas of innovation in 6G-SHINE are pictorially depicted in the figure. Physical layer research in 6G-SHINE is meant at leveraging the advantageous short-range characteristics of in-X subnetworks for supporting demanding communication requirements in terms of delay, reliability, or data rates at low energy consumptions. Relevant technology components include beamforming/beamfocusing, reconfigurable intelligent surfaces (RIS), and self-conjugating metasurfaces able of retro-directing incoming signals into the same impinging direction, drastically reducing delays associated to beam alignment and beam tracking.

Medium access control research focuses on predictive scheduling solutions, where context information and knowledge of underline application and service characteristics, can be used for proactively allocating radio resources, thereby reducing the needs of time and resource consuming signaling. Also, novel solutions for multiplexing traffic with diverse characteristics (e.g. high data rates video feeds with fast closed loop control traffic) leveraging flexible and full duplexing capabilities in the subnetwork nodes are studied. Despite short-range communication,

the presence of blockage can jeopardise communication reliability; solutions based on cooperative communication and network coding are explored.

In-X subnetworks should be able to operate standalone, since they may support services that are not allowed to be interrupted at any time. Still, they are part of a larger 6G landscape, and can therefore benefit from connection with a parent 6G network. Since in-X subnetworks can spontaneously become very dense, the efficient management of radio resources is of paramount importance for ensuring the fulfillment of demanding communication requirements. 6G-SHINE is exploring solutions where radio resource management capabilities are distributed between the in-X subnetworks and the 6G parent network, also leveraging AI methods in the solution space.

In-X subnetworks clearly represent an architectural innovation. 6G-SHINE will develop new methods for cost effective and constructive integration of subnetworks into the larger 6G network. Short-range radio channel modeling at different spectra of interest (below 20 GHz, mmWave, sub-THz) is also studied in the project.

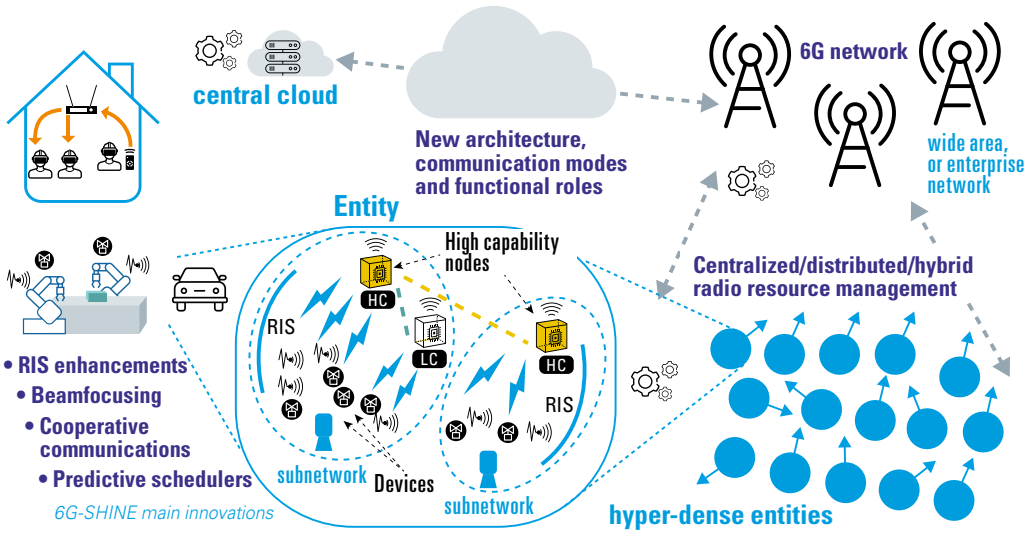

USE CASE/ SCENARIOS

Relevant use case categories for in-X subnetworks identified in the project are consumer, industrial and in-vehicles. Consumer subnetworks use cases include in-classroom immersive education (leveraging XR applications), indoor arena gaming, live virtual production and augmented reality (AR) navigation. Industrial subnetwork can

be used for the wireless control of robot operation, unit test and visual inspection cells. Also, a subnetwork can be formed by a group of robots involved in a cooperative task. In-vehicle subnetworks can replace wired connections between sensors and ADAS cameras and electronic control units (ECUs).

FIRST RESULTS

During the first year of the project, 13 relevant use cases spanning the three categories of interest have been identified by the project partners. Their relevant key performance indicators and related traffic characteristics have been defined, as well as their potential in addressing environmental, economic and –where relevant– societal sustainability. 6G-SHINE has also defined new categories of network elements, based on their computational, communication and power consumption capabilities. Specific roles related to communication, management and computing functionalities have been identified, along with functional requirements for the use cases.

For further enhancements based on scheduling coordination and beam-aware radio resource management. Also, the novel paradigm of self-conjugating metasurfaces allows for beam alignment within 20 μ s without channel state information acquisition and signaling overhead. Early results have also shown the capability of cooperative communication within a subnetwork being able to significantly reduce the emitted power of around 7 dB, while keeping tight cycle time constraints. For subnetworks operating in the unlicensed spectrum, we have proposed a novel latency-aware access scheme where critical traffic can access the medium in a deterministic manner via Latency Aware Deconfliction periods. The proposed solution can reduce the medium access delay up to ~75% compared to standard channel access mechanisms, without penalising best effort traffic.

Early physical layer research results highlight the benefits of antenna panels for enhancing short-range communication performance, especially in case of dense subnetworks, paving the way

6G Short range extreme communication IN Entities



Coordinated by
Gilberto Berardinelli
(Aalborg University)

March 2023 – August 2025

Website: www.6gshine.eu

X: twitter.com/6gshine

LinkedIn: www.linkedin.com/in/6g-shine-project-277a9626a/

Verticals concerned :
Industrial, vehicular, consumer

Project Consortium Members:

Aalborg University, CNIT, University Miguel Hernandez de Elche, Apple Germany, Sony, Bosch, Interdigital, Fraunhofer IIS, imec, Keysight, Nokia Denmark, Cogninn



6GTANDEM

By co-designing novel dual-frequency operation and an innovative highly integrated and distributed radio stripe system, 6G Tandem will create superior value in energy consumption, service availability and system cost.

OVERVIEW

The 6GTandem project addresses key challenges in the SNS programme to support future 6G applications and in particular focuses on novel PHY-layer solutions to provide increased QoS requirements. It thereto researches the transmission in sub-THz bands exploring a novel dense deployment approach based on RF-transmission over fibre and providing support of lower frequencies for operating the network and increasing the reliability.

The consortium regularly interacts with the SNS community through generic events, and in dedicated interactions. For example, there were interesting discussions with Luca Sanguinetti who is leading the related SNS project TIMES, at the occasion of a future wireless event (organised by Emil Björnsson of KTH in Stockholm, August 2023).

6GTandem aims to achieve competitive advantage by defining and shaping the future of 6G infrastructures in Europe and contributing to the long-term impact of smart, flexible, and scalable Radio Access Network (RAN) evolution and offering hardware products

that will reach a unique level in terms of Radio Frequency (RF) performance, cost-, spectrum- and energy-efficiency in the global market.

In particular, 6GTandem focuses on the following objectives:

- Develop the 6GTandem system concept presenting an optimised combination of a lower-frequency infrastructure and a sub-THz radiostripe.
- Develop models for the tandem system in terms of hardware impairments, propagation in the plastic fibre waveguide, and impact of the radio environment.
- Design waveforms for dual-frequency systems with control information.
- Develop fully integrated communication links at sub-THz frequencies based on plastic microwave fibres.
- Demonstrate and validate the proposed concept to identify performance bottlenecks and to guide the future research directions in- and beyond the project lifetime.

CONCEPT/ARCHITECTURE

As we mark the completion of the first year of the 6GTandem project, we are eager to share the progress made during this dynamic three-and-a-half-year journey. While some projects have addressed the 6G vision, the needed services of the 2030s and key technology enablers are yet to be defined. 6GTandem stands as ground-breaking initiative, providing low cost and lightweight radio stripes that enable flexible deployment on ceilings and

walls, addressing challenges from the design of hardware components, such as chips, to ensuring the seamless operation of the entire system.

Our primary focus revolves around the dense deployment of sub-THz radio units to deliver high data rates, complemented by sub-10GHz radio coverage to ensure a reliable connection. We are pleased to report that every facet of the project is progressing well.

USE CASES/ SCENARIOS

Use cases, requirements, and deployment scenarios have been identified, emphasising indoor environments that require high throughput, low latency, and reliable wireless communication.

We are actively optimising radio stripe deployment, exploring ideal distances between radio units, and determining

the total length of radio stripes for energy efficient operation. Our commitment to sustainability extends to ensuring the system remains flexible for energy efficiency. The 6GTandem journey is about pushing boundaries and envisioning a future where wireless communication seamlessly integrates into our lives.

FIRST RESULTS

The team initiated WP2 "*Use cases, system requirements*" by conducting a comprehensive literature review on recent projects in the European Union's 6G landscape and standardisation documents. They categorised relevant 6GTandem use cases based on system Key Performance Indicators, focusing on deployment scenarios in arenas, metro stations, and industrial manufacturing sites. Concurrently, they explored various sub-THz over-the-air link budget scenarios, considering factors such as bandwidth and modulation schemes, with results compiled into D2.1 "*Report on use cases, deployment scenarios and requirements*". Essential models, detailed in D2.2 "*Report on the planned models and requirements*", were gathered, and groundwork for the hardware demonstrator has commenced, signifying a crucial step in translating theory into practical applications within the dynamic landscape of 6GTandem.

In the latter part of 2023, WP3 "*Models, medium-aware waveforms, and algorithms for energy-efficient, robust, and new 6GTandem services*" initiated research and development for a wireless communication system, focusing on two key activities. First, they worked on developing models for analytical and simulation-based system studies, addressing transmission over plastic fibre, wireless propagation at sub-THz, and the impact of non-perfect hardware. Second, the exploration of dual-frequency tandem system concepts aimed at achieving a high-capacity network in

quasi-static environments and supporting new 6G functionalities. The communication system exploration involved initial link budget analysis, highlighting constraints on signal power and linearity, leading to the exploration of high-bandwidth signals and dense deployments to achieve the targeted very high throughput in the network. Cooperation between hardware and system experts was crucial for this work.

WP4 "*D-MIMO Sub-THz radiostripe*" has made significant strides in developing fully integrated communication links at sub-THz frequencies (130-175 GHz) using plastic microwave fibres (PMFs). Achievements include successful collaboration between Ericsson, Chalmers University, Infineon, and Lund University on system architecture and packaging options. Notably, Infineon and Lund University are actively designing compact Sub-THz Antenna-in-Package (AiP) solutions for distributed deployment, with a related publication submitted to the 2024 European Conference on Antennas and Propagation. Chalmers University has also successfully submitted chip designs, including amplifiers, frequency multipliers, mixers, phase shifters, and switches, contributing to advancements in the project's chip design objectives. The collaborative effort includes Huber+Suhner's contributions through the delivery of PMFs to Infineon and performing simulations to enhance discussions.

*A Dual-frequency
Distributed MIMO
Approach for Future
6G Applications*



Coordinated by
Barbara Gaggl, Technikon
January 2023–June 2026

Website: horizon-6gtandem.eu/

X: twitter.com/6gtandem_he

LinkedIn: [6gtandem-horizon-europe-project-101096302/](https://www.linkedin.com/company/6gtandem-horizon-europe-project-101096302/)

Project Consortium Members:
Technikon, Ericsson, Catholic University of Leuven, Chalmers University of Technology, Linköping University, Lund University, Infineon Technologies Germany and Austria, Huber + Suhner



ADROIT6G

A Distributed AI-enabled Framework for the Management of Next-generation 6G Architectures.

OVERVIEW

ADROIT6G's overall project goal is to evolve the existing service-based architectures of 5G mobile networks. It is designing and implementing a fundamentally new approach for a future-proof, cognitive, next-generation 6G architecture by adopting a fully distributed AI-driven dynamic paradigm. In the proposed novel architecture functional elements are automatically deployed on-demand as virtual functions across the far-edge, edge and cloud domains, operated by different stakeholders. This will ultimately lead to improved performance, a higher level of control, increased transparency in interactions with digital services, support of future-looking applications and social acceptance.

ADROIT6G focuses on the following key objectives:

1. Design and implement a novel 6G system architecture that integrates a distributed AI framework for combined communication, computation and control.
2. Create an AI-driven Management and Orchestration (M&O) and control framework for 6G Networks.
3. Architect a distributed and secure Crowdsourcing AI.
4. Develop energy-aware models for multimodal Representation Learning.
5. Evolve the cellular infrastructure to allow the true integration of far-edge devices in communication and computation functions.
6. Enable Non-Terrestrial Networks connectivity for highly reliable Industrial Internet of Things Services.
7. Extend and demonstrate the use of decentralised AI for Device-to-Device (D2D) communications.
8. Support data plane acceleration.
9. Integrate and demonstrate the potential and user value of ADROIT6G through relevant experimentation, testing, and validation of its innovations in PoCs in lab settings.
10. Make significant contributions to the establishment of a set of globally accepted KVIs.

The ADROIT6G project is part of the HORIZON-JU-SNS STREAM-B-01-01: "System Architecture" group of projects. As such, it is supporting the European Commission's 6G policy by implementing the first phase of the 6G SNS roadmap towards the evolution of a 6G architecture.

Distributed Artificial Intelligence-driven open and programmable architecture for 6G networks



Coordinated by
Christos Verikoukis (ISI/ATH)
January 2023–December 2026

Website: <https://adroit6g.eu/>

X: twitter.com/adroit6g

LinkedIn: www.linkedin.com/company/adroit6g/

Verticals concerned:
Extended Reality, Industrial IoT,
Collaborative Robots, NTN

Project Consortium Members:
ISI/ATH, CYENS, CNIT, EURECOM,
University of Oulu, Mellanox Technologies,
NOVA Telecommunications, SIEMENS,
Orange Romania, CAFA Tech, eBOS
Technologies, IQUADRAT Informatica,
Nextworks.



CONCEPT/ARCHITECTURE

As the world moves towards the 6G era, the mobile communications fabric needs to be architected differently to accommodate the requirements of emerging applications that cannot be served by existing 5G mobile networks. ADROIT6G proposes disruptive innovations in the architecture of 6G mobile networks that will make fundamental changes to the way

networks are designed, implemented, operated, and maintained. Such innovations include:

- AI/ML-powered optimisations across the entire network, for high performance and automation.
- Transforming the cellular network to a fully cloud-native network software, which can be implemented

across a variety of edge-cloud platforms, including Non-Terrestrial Networks, with security built integrally into the network user plane.

- Software-driven, zero-touch operations and ultimately automation of every aspect of the network and the services it delivers.

USE CASES/ SCENARIOS

The project is addressing a radically new approach for a next-generation AI-enabled open architecture for future 6G networks, and therefore, it requires continuous design and refactoring. The design, implementation, testing, and usage of ADROIT6G will go in parallel with the validation in lab settings, and a lot of feedback and re-design of platform components may be expected because of a better understanding of the challenges faced with the integration of novel concepts, components, and their usage in future looking applications. Henceforth, new

technologies and tools may succeed and be integrated into the project’s design/ development cycle. ADROIT6G will be open to rapid changes and elicitation of new requirements stemming from the UCs in the PoCs.

ADROIT6G innovations, functionalities, and performance will be validated through three representative extreme 6G use cases (UCs), namely Holographic Telepresence, Industrial IoT – also demonstrating the capabilities of NTN interworking with terrestrial 6G networks, and Collaborative Robots/Drones in corresponding Proof of Concepts.

FIRST RESULTS

The ADROIT6G project has defined a reference architecture that comprises four major Blocks: i) an **AI-driven Management and Orchestration Framework**, which is essential for the management of the distributed applications and services across the various infrastructures, extending from traditional cloud environments to the heterogeneous edge and the far edge/ device layer. ii) a **Framework for CrowdSourcing AI**, which represents a novel approach targeting to enhance network operations, network management, and service delivery through the

use of Artificial Intelligence (AI). iii) an **AI-driven Control Operations Framework**, which targets to harness storage, computational and network-ing resources of the ubiquitous smart Mobile Devices (i.e., Smartphones, Tablets, etc.), for augmenting the network’s cellular, storage, and computational capabilities and iv) **Closed-Loop Functions** which are designed to address the complexities inherent in managing 6G networks by leveraging automation to optimise network and service operations while efficiently utilising infrastructure resources.

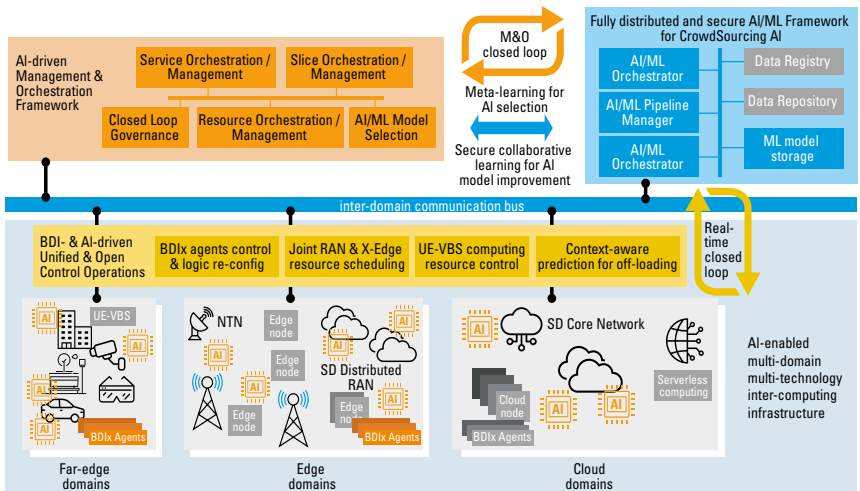

CENTRIC

Using AI for wireless network design meet users' communication needs and environmental constraints.

OVERVIEW

Project Objectives

1. To develop AI methods for the discovery of novel and efficient waveforms
2. To develop AI methods for the discovery of novel and efficient transceivers
3. To develop AI methods for the discovery of customised lightweight communication protocols
4. To introduce novel end-to-end hardware co-design solutions for energy-efficient AI-native transceivers
5. To develop training and monitoring environments as enablers for AI-AI deployments
6. To validate user-centric AI-AI solutions in lab setting
7. To demonstrate and disseminate AI-AI concepts

CONCEPT/ARCHITECTURE

CENTRIC advocates for an approach to 6G communications whereby the application's requirements define the starting point for the design of the underlying protocol stack. An AI-native air interface (AI-AI), proposed by CENTRIC, will bring forth a

degree of physical layer and protocol stack customisation unseen in the history of communication engineering. Leveraging the AI-AI, each user will benefit from the type and amount of connectivity it needs, whenever and wherever it needs it.

FIRST RESULTS

Separate Training Framework for AIML-based CSI Compression

Channel State Information (CSI) acquisition at the Base Station (BS) received from each User Equipment (UE) is critical to sweep its beam towards the corresponding UE accurately. However, transmitting uncompressed CSI in limited-rate feedback channels is impossible due to the significant signalling overhead in the uplink channel. This motivates us to exploit the potential of employing Artificial Intelligence/Machine Learning (AIML) for CSI compression and reconstruction. To address this issue, Nokia developed a separate training collaboration scheme as part of the CENTRIC collaboration framework, which has gained support both from UE vendors and NW vendors in standardisation fora. The proposed solution allows the UE-side CSI generation part and

the network-side CSI reconstruction part to be trained separately by the UE side and network side, respectively.

Adaptive Non-Uniform Quantisation for CSI Compression

The CENTRIC focus on improving the performance of quantisation-non-aware models by introducing adaptive non-uniform quantisation of the CSI compression (i.e., for the output of CSI encoder). Based on our observation that the latent variables follow a non-uniform distribution, we have proposed and evaluated two different adaptive non-uniform quantisation methods, clustering-based and cumulative distribution function (CDF)-based. Additionally, the distribution of latent variables shows different statistics among different latent variables. Therefore, we have further proposed and evaluated non-uniform

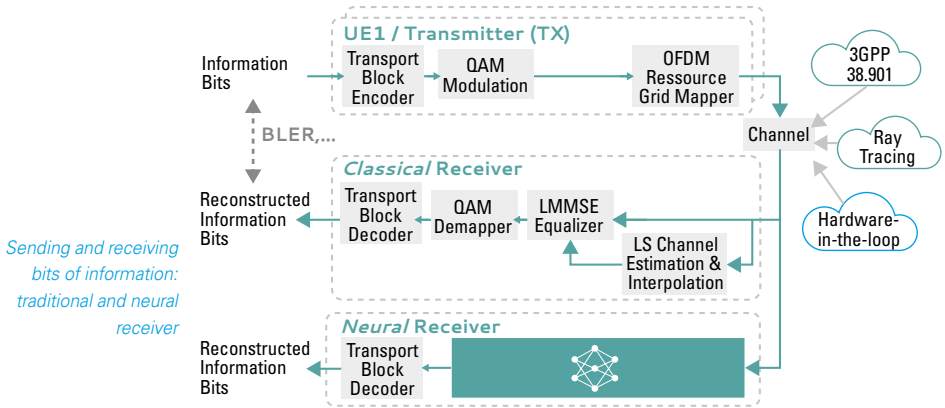

Sending and receiving bits of information: traditional and neural receiver

quantisation considering per-latent and across-all-latent distributions.

Neural Network (NN)-based Multiuser Multiple-Input Multiple-Output (MU-MIMO) Receiver

One of the objectives of the CENTRIC project is to develop a user-centric communication stack that can be tailored to user-specific needs. For this, we introduce a neural network (NN)-based multiuser multiple-input multiple-output (MU-MIMO) receiver with 5G New Radio (5G NR) physical uplink shared channel (PUSCH) compatibility. To showcase the practicability of the approach, we have presented a hardware-in-the-loop demonstrator at the Brooklyn 6G Summit 2023. A specific focus of the neural network architecture is on flexibility concerning a varying number of users and a configurable number of subcarriers. The proposed architecture (figure above) does neither require any retraining if additional users join or leave the

network, nor if the number of allocated subcarriers or physical resource blocks (PRBs) change. The neural receiver and our experiments are implemented using NVIDIA Sienna library for link-level simulations.

Safe Model Predictive Control via Reliable Time-Series Forecasting

The control of dynamical systems is the backbone of modern technologies, ranging from industrial processes to autonomous vehicles. In many of these scenarios, systems must be controlled while satisfying a set of safety and reliability constraints concerning the unknown evolution of a target process. In our recent work, we proposed Probabilistic Time Series-Conformal Risk Prediction (PTS-CRC), a novel calibration procedure that enables reliable modelling of uncertainty regarding future system states. PTS-CRC predictions can be used to solve model predictive control problems under reliability, safety, and performance constraints (figure below).

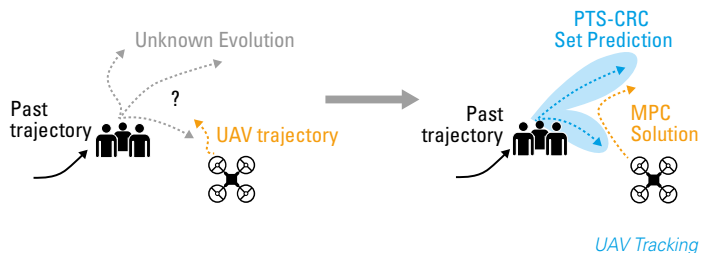

Towards an AI-native, user-centric air interface for 6G networks



Coordinated by Dr.-Ing. Halid Hrasnica, Eurescom GmbH

January 2023-June 2025

Website: <https://centric-sns.eu/>

X: twitter.com/project_centric

LinkedIn: www.linkedin.com/company/centric-project/

Project Consortium Members: EURESCOM, Nokia Networks France, Aalborg University, NVIDIA, CNIT, Consiglio Nazionale Delle Ricerche, Sequans Communications, University of Oulu, Keysight Technologies Spain, Nokia Solutions and Networks Germany, Synthara, King'S College London, Interdigital Europe.



CONFIDENTIAL6G

Ensure secure and private computation in the cloud-edge continuum of 6G by developing modern cryptographic techniques, tools, and libraries.

OVERVIEW

In CONFIDENTIAL6G, our goal is to ensure secure and private computation in the cloud-edge continuum of 6G by developing modern cryptographic techniques, tools, and libraries. We aim to tackle the potential danger posed by near-future quantum computers, which can break contemporary encryptions, by exploring novel cryptographic operations.

The objectives of the CONFIDENTIAL6G project encompass a comprehensive exploration and definition of advanced security enablers, cryptographic primitives, libraries, and tools tailored for confidential computing in the context of 6G. This includes addressing the complexities of multi-party AI/ML and networking within decentralised blockchain networks. A key focus is on overcoming challenges related to open-source solutions and ensuring multi-vendor interoperability. The project aims to prototype methods for confidential computing that are not only efficient and sustainable but

also attestable, GDPR compliant, and securely implemented through a combination of hardware and software mechanisms. These methods are designed to support collaborative privacy-preserving AI/ML scenarios involving multiple stakeholders and tenants. Furthermore, the CONFIDENTIAL6G project involves the design and development of a secure and privacy-preserving edge-cloud networking infrastructure specifically tailored for orchestrating confidential collaborative computing. This includes facilitating distributed and federated machine learning operations in a secure manner.

The consortium has been set up in accordance to provide a multi-layer complementarity bringing together internationally renowned researchers with strong expertise in Cryptography, Distributed systems, Networking, Machine Learning, Distributed Ledger technology, Multi-party computations, and Orchestration.

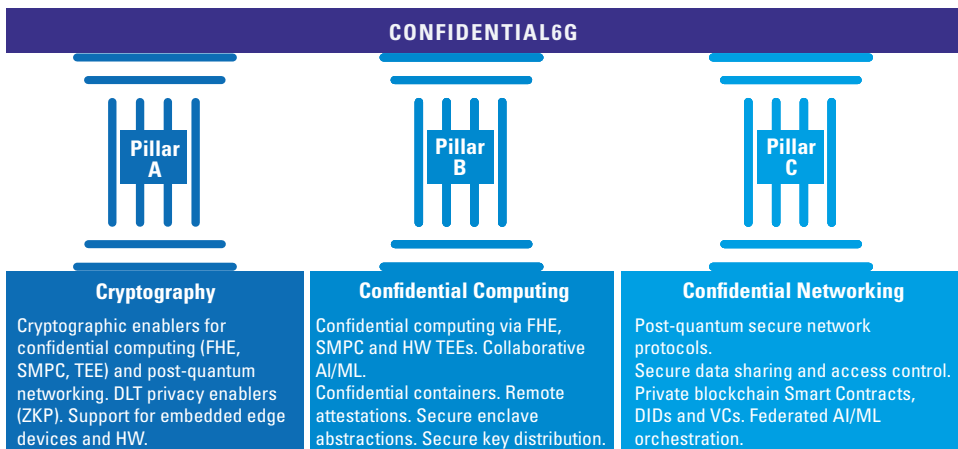

CONCEPT/ ARCHITECTURE

Emphasising a comprehensive approach, the project integrates AI tools, hardware components, and IoT devices to ensure a secure and private 6G network. Built on three pillars—post-quantum cryptography, confidential

computing, and confidential communication—CONFIDENTIAL6G pioneers advanced tools and libraries, ensuring confidentiality through cryptographic enablers and secure multi-party computation.

USE CASES/ SCENARIOS

To validate the constituent components that will be integrated into a unified fully-functional platform, CONFIDENTIAL6G will execute iterative small-scale validation in 3 use cases. The deployment and demonstration at the pilot sites, with a period of operational evaluation of the project based on the expected results, will be tested in diverse scenarios: Predictive

maintenance for airline consortium using blockchain-based data sharing platform and federated AI/ML orchestration; Privacy-preserving confidential computing platform that enables mitigation of internal threats for telecom cloud providers; and Intelligent connected vehicle, mission-critical services, OTA updates, FL/ML and vehicle to infrastructure communication.

FIRST RESULTS

One of the first CONFIDENTIAL6G key results is an in-depth analysis of the state-of-the-art in Post-Quantum Cryptography (PQC). This serves as a comprehensive toolkit for the algorithms currently considered by NIST for standardisation and its results are expected to be exploited by other further work in the project that pertains to PQC integration in network protocols. Additionally, the design of secure communication protocols and algorithms resistant to attacks from quantum computers, known as Quantum-safe Networking Primitives, will be used to safeguard against future quantum threats. In parallel, the development of secure network architectures and mechanisms for data protection has led to the creation of Secure Architecture and Mechanisms, ensuring robust defense layers against potential cyber threats. With regards to data privacy and confidential computing, the project has developed several Machine Learning (ML) algorithms that support Fully Homomorphic Encryption (FHE) and have been testing them against

industrial test data. These efforts are complemented by improved data privacy in federated AI/ML through better orchestration mechanisms within confidential computing environments, termed Federated AI/ML Orchestration. In a complementary fashion, solutions based on Zero-Knowledge Proofs (ZKP) that could potentially solve the verifiability issues of FHE computations, while also leveraging blockchain for data verification and access control are being investigated, with privacy enhancements using cryptographic techniques (Blockchain-based Data Verification and Access Control). Moreover, novel schemes for threshold signatures are investigated, an architecture for a Trusted Execution Environment (TEE) that supports multi-party computations (MPC) is designed. Finally, a blockchain-based solution with a novel consensus mechanism called Proof of Chosen for training ML Models is developed, marking significant strides towards secure and private computing in the digital age.

Confidential Computing and Privacy-preserving Technologies for 6G



Coordinated by
Vera Stavroulaki (WINGS-ICT)
January 2023–December 2025

Website: <https://confidential6g.eu/>

X: twitter.com/C6G_eu

LinkedIn: www.linkedin.com/company/c6g-project/

Verticals: Automotive, Airline,
ICT infrastructure

Project Consortium Members:
WINGS-ICT, Alcatel Lucent International,
Nokia Solutions and Networks, Technical
University of Eindhoven, UltraViolet Consult,
Zentric Lab, VTT, TNO, Foundation IMDEA
Software, Technical University of Graz,
Friedrich Alexander
University of Erlangen.



DESIRE6G

Meeting extreme KPIs through Deep Programmability in 6G AI-Native Systems.

OVERVIEW

One of the primary goals of 6G should be simplicity, as the organic outcome of using cutting-edge technologies such as the ability to programme the user plane, cloud-native features like automatic scaling and failover, seamless acceleration of network functions (NFs) or application workloads, and artificial

intelligence-driven network automation. To this end, the DESIRE6G project proposes a novel architecture that utilises and expands upon these promising technologies with the aim of supporting diverse use cases, while focusing on addressing the challenges of ultra-low latency, mission critical control loops.

CONCEPT/ARCHITECTURE

The figure above illustrates the DESIRE6G (D6G) system organised into four layers. The system is deployed on distinct D6G sites across the edge-to-cloud continuum. Each site can contain hardware accelerators and traditional compute resources, running the (virtualised) NFs necessary for the execution of the deployed network services, and application functions (AFs). Sites vary based on requirements and location, e.g., sites supporting RAN operation are equipped with COTS hardware including accelerators, FPGAs/ASIC boards, RF antennas etc. One of the novelties of our architecture is the D6G UE that may run a stripped-down version of the D6G stack, enabling E2E monitoring and service control. The D6G layers are outlined in the following:

- **Intent-based Orchestration Layer:** The Service Management and Orchestration (SMO) platform is responsible for orchestration, lifecycle management and automation of E2E network services (NSs), in line with current specifications (i.e., O-RAN, ETSI MANO). Towards that end, the DESIRE6G SMO focuses on activities such as ML-powered intent-based service management, orchestration of AI/ML workflows, network service federation employing Distributed Ledger Technology (DLT) and data management and exposure services pertaining to the SMO/non-RT RIC. Its northbound API enables the full operation of system and the NSs.

- **Optimisation and Control Layer:** DESIRE6G implements distributed network intelligence employing a Multi-Agent-System (MAS) closer to the physical infrastructure, responsible for service-specific optimisations, receiving monitoring information and fine-tuning the network and compute resources accordingly. It employs and dynamically configures the D6G pervasive telemetry system to receive service specific performance indicators, e.g., end-to-end latency for latency-critical services. The MAS is secured with binary hardening of the agents and a lightweight application based DLT for dynamic multi-agent association.

- **Programmable data plane (PDP) layer:** The E2E PDP employs highly disaggregated NFs and AFs to carry out the logic of each selected service. By hiding the complexities of the underlying execution environments and hardware entities from the logical view of the service, this layer offers a cloud-native-like data plane design with transparent scaling / failovers and hardware acceleration. The infrastructure management layer (IML) is at the heart of the PDP layer, responsible for bridging the logical view and the physical world: it supports virtualisation while seamlessly accessing and controlling hardware accelerators and functionalities like service routing, flow-aware load balancing and heavy hitter handling.

Deep Programmability and Secure Distributed Intelligence for Real-Time E2E 6G Networks



Coordinated by
Chrysa Papagianni
(University of Amsterdam)

January 2023–December 2025

Website: <http://desire6g.eu>

X: twitter.com/desire6g_eu

LinkedIn: linkedin.com/in/desire6g-project

Verticals concerned:
Augmented Reality, Digital Twins

Project Consortium Members:
Ericsson, NEC Labs Europe, NVIDIA, Telefonica, University of Amsterdam, University Carlos III of Madrid, Eötvös Loránd University, University of Oulu, Technical University of Catalunya, Sant'Anna School of Advanced Studies, National Inter-University Consortium for Telecommunications, Nubis PC, Tages Solidshield, Accelleran



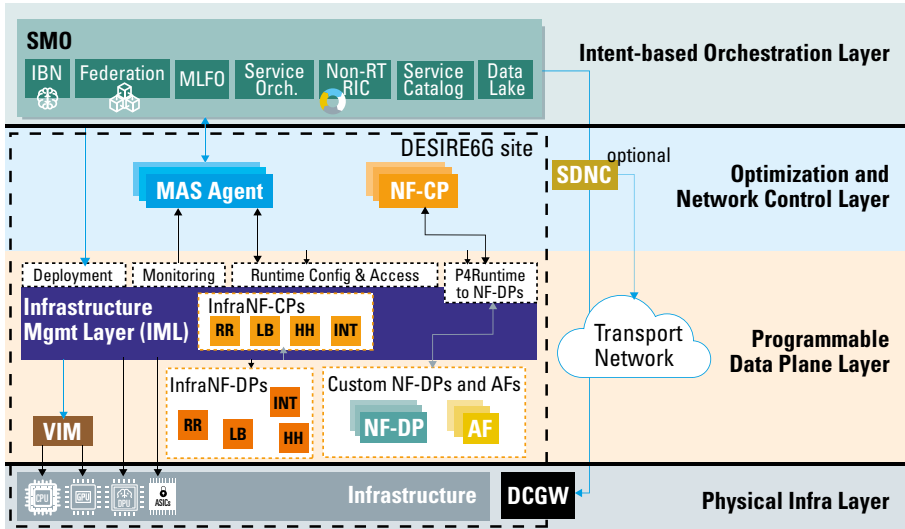

USE CASES/ SCENARIOS

The proposed innovations will be validated and evaluated utilising the 5TONIC laboratory (<https://www.5tonic.org>) in Spain and the ARNO testbed (<http://arnotestbed.santannapisa.it>) in Italy. DESIRE6G focuses on two representative 6G use cases, featuring Augmented Reality (AR) and Digital Twin (DT) industrial applications. The first use case involves an AR surveillance and inspection application offering a (perceived) zero latency immersive experience to the end-user. The application aims to exploit a camera-equipped drone to perform inspection of the area of interest, collect images and send them to an edge computing node to perform data analysis and object detection. The operator via the headset will be able to control the drone's operations, e.g., select the cameras' direction and/or focus on specific objects. Using the D6G software stack, it will showcase AI-powered and hardware-accelerated communication to enhance AR, reaching new level

of interaction between the user and the connected system. Moreover, AI-augmented object detection will grant the user a versatile way to quickly scan wide areas, gaining valuable information about the surroundings. The second use case involves an operational Robot DT, where robots continuously transmit sensor data upstream (e.g., lidar, camera, odometry, joint states) to update their virtual models, while simultaneously they receive real-time navigation instructions in the downstream. We will showcase that the system can support the required ultra-low latency of the control loops and their respective reliability requirements, through the proposed innovations at the control and data plane (in-network acceleration and optimisation etc.). Both use cases can benefit from the D6G E2E service orchestration and MAS layers to enable granular service life-cycle management with optimised resource and energy consumption.

FIRST RESULTS

Current and envisaged use cases, extending beyond 2030, require a more flexible and dynamic network architecture. 6G systems are expected to further broaden the range of vertical sectors supported, with reduced complexity while pushing performance limits even further. DESIRE6G addresses these objectives by proposing an AI-powered intent-based cloud native 6G system

architecture supported by a performant, measurable, predictable, and customisable data plane. With the initial architecture and interface specifications at hand, along with the software releases of novel functionalities/components, DESIRE6G will technically validate the proposed innovations via PoCs as well as assess the sustainability of the DESIRE6G system through techno-economic studies.

DETERMINISTIC6G

Paving the way to groundbreaking E2E dependable time-critical communication architecture powered by 6G.

OVERVIEW

The DETERMINISTIC6G project aims at developing architectures and algorithms for scalable and converged future network infrastructures to enable dependable end-to-end (E2E) time-critical communication across wired and 6G wireless domains. The objectives of the project are as follows:

- Definition of deterministic services including KPIs and KVIs for 6G visionary use cases.
- Design and develop 6G features for deterministic wireless transmission and wireless-friendly enhancements for Time-Sensitive Networking (TSN) and Deterministic Networking (DetNet).
- Develop AI/ML based techniques for data-driven latency characterisation of 6G wireless systems.
- Develop 6G time synchronisation solution to ensure end-to-end time awareness and new concepts for deterministic edge cloud solution for integration in the 6G system.
- Conceive a security architecture and framework for 6G deterministic communications.
- Develop a validation framework for new 6G concepts.

The DETERMINISTIC6G architectures and algorithms for dependable communication will allow efficient interconnectivity between physical, digital, and human-centered worlds to enable many future innovative applications. DETERMINISTIC6G finds itself in close connection with DESIRE6G, PREDICT-6G, and TARGET-X in developing novel solutions for intelligent dependable programmable networks

CONCEPT/ARCHITECTURE

DETERMINISTIC6G focuses on defining system aspects for E2E dependable, time-critical communication, including the design of technology enablers, and development of a validation framework through system modelling and simulations (see figure). The project takes a novel approach towards converged future infrastructures for scalable cyber-physical systems deployment where integration of stochastic elements (like wireless links and computational elements) with respect to their stochastic behavior can be captured. Therefore, system enhancements to mitigate stochastic variances in communication and computation are being developed through methods such as packet delay correction (PDC)

to ensure bounded and predictable latency behavior within 6G networks. Among other things, data-driven methods for latency prediction, resource allocation strategies, and extension of the legacy deterministic communication systems (TSN, DetNet) to enable them for handling stochastic characteristics of 6G wireless networks are focused. Because E2E deterministic communication will require data offloading, and computation in a secure fashion, the project is also developing edge computing modeling to ensure deterministic operations, a security framework, and digital twinning concepts. Finally, the developed concepts will be validated through a simulation and modelling framework.

E2E deterministic system architecture

System aspects for deterministic E2E communication

- 6G use cases requiring deterministic communication
- Deterministic service definition (KPI/KVI)
- Security analysis
- E2E architecture

Deterministic communication technology enablers

- Deterministic 6G wireless transmission design
- Data driven characterization for 6G wireless system
- E2E time synchronization

- Deterministic communication standards (TSN, DetNet) evolution
- Edge computing solution for deterministic communication
- Situational awareness via digital twins
- Security countermeasures

Validation framework

- System level modelling
- Data driven model evaluation and validation
- System level simulations

DETERMINISTIC6G approach and concepts

USE CASES/ SCENARIOS

DETERMINISTIC6G defines four visionary use cases where E2E deterministic communication in a converged wireless and wired communication system is required. These use cases include fully immersive extended reality (XR), exoskeletons, adaptive manufacturing, and smart farming. XR can be useful for teaching, training, visualisation, collaboration or maintenance, and control of industrial systems. Exoskeletons are becoming an effective tool to reduce the physical burden of workers performing demanding activities. Exoskeletons will exchange data with a centralised system and interoperate with different modules of the industrial ecosystem. Adaptive manufacturing allows dynamic

adaptation of manufacturing processes to respond quickly to market needs. 6G is expected to contribute as a key enabler for using wireless-controlled modular machine parts, collaborative automated guided vehicles (AGVs) or optimised AGV routing. Lastly, smart farming refers to automation of farming activities and processing of data for diagnostics and treatment of fields, automating recurring and hazardous tasks, predicting potential problems and maintenance issues, as well as implementing techniques to keep crops safe from unpredictable weather and pests. Automation based farming utilising IoT, 6G, AI, and edge-computing based technologies can significantly improve the overall farming process.

FIRST RESULTS

DETERMINISTIC E2E COMMUNICATION WITH 6G



Coordinated by
János Harmatos, Ericsson
January 2023–June 2025

Website: www.deterministic6g.eu

X: twitter.com/DETERMINISTIC6G

LinkedIn: www.linkedin.com/company/deterministic6g/

Verticals concerned:
Industrial automation

Project Consortium Members:
Ericsson, B&R industrial automation, Orange, ABB, (lined third party), Cumucore, Montimage, IUVO, KTH Royal Institute of Technology, University of Stuttgart, Silicon Austria Labs, and School of Advanced Studies Sant'Anna.



The project activities started with the identification of visionary use cases that require dependable time-critical communication. A detailed use case analysis is performed including the derivation of KPIs and KVIs and key architectural aspects such as 6G centric enablers, wireless-friendly design of E2E deterministic communication, deterministic support in the compute domain, security aspect, and digital twinning. Results are produced in the areas of PDC to control the jitter to tens of microseconds over the radio transmission ensuring predictable delay, deep neural network-based latency prediction approach and related architecture framework and RAN resource allocation strategies for XR use case. The evaluation of the above

methods will be performed while advanced AI-based latency prediction methods are planned to be developed in the next phase. Moreover, a wireless-friendly, adaptive end-to-end scheduling framework covering the wired (TSN/DetNet) and 6G domains is proposed. Similarly, a security monitoring framework and software are developed for 6G networks. Lastly, the first version of the simulation framework is released that can perform E2E simulations by leveraging different packet delay variation models for wired bridges, wireless 5G nodes and processing delay models for the edge computing domain. The simulation framework will be extended towards supporting control plane feature.

ETHER

ETHER is going to provide a framework for the terrestrial/non-terrestrial network ecosystem that involves efficient and zero-touch resource management, provides solutions for key RAN challenges, and identifies the business opportunities for potential stakeholders.

OVERVIEW

ETHER's objectives are:

1. To provide solutions for a unified and sustainable 3D RAN.
2. To provide an AI-based framework for the self-evolving network slicing management and orchestration.
3. To architect a viable, highly energy- and cost-efficient architecture.
4. To showcase ETHER's solutions by experimentation.
5. To identify the key benefits that will drive the investment in the integration of non-terrestrial with terrestrial networks.

CONCEPT/ARCHITECTURE

The envisioned ETHER 3D network is illustrated in the figure below.

The ETHER technical innovations are the following:

1. Cost- and energy-efficient integrated architecture.
2. Direct handheld device access at the Ka band.
3. Unified waveform design.
4. Flexible payloads.
5. Data analytics, edge computing, and caching.
6. Horizontal/vertical handovers.
7. Automated MANO for the integrated network.
8. AI-driven E2E network performance optimisation.

ETHER 3D network.

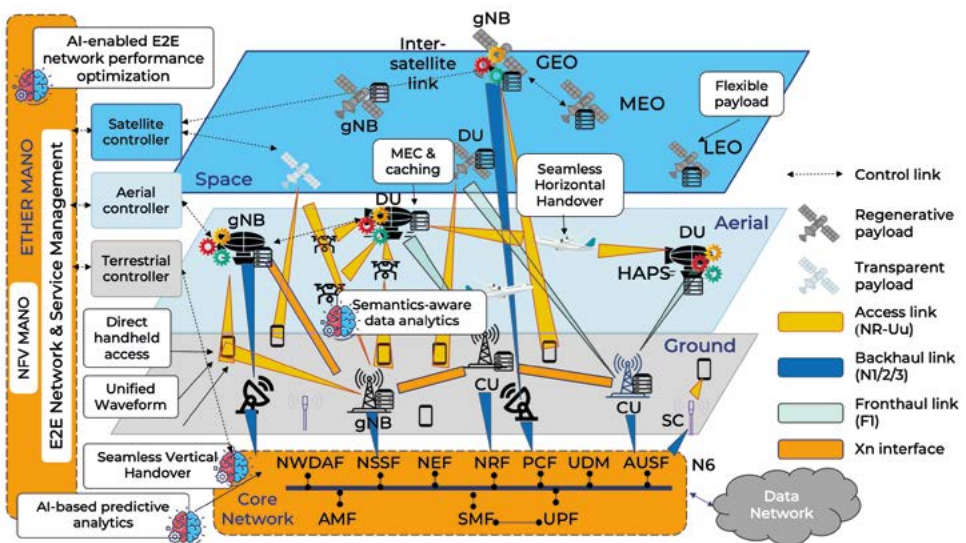

**USE CASES/
SCENARIOS**

ETHER has identified three use cases:

- 1. Use case 1-ETHER service provisioning for delay-tolerant IoT applications:** This use case concerns the provisioning of network coverage from LEO satellites with service and feeder link discontinuity will bring global coverage to delay-tolerant mMTC applications. Furthermore, providing service with multiple technologies by means of flexible payload allows for a higher number and variety of supported devices and applications, which opens for a bigger market impact and reduces vendor and technology lock-in.
- 2. Use case 2-Unified RAN for direct handheld device access in the Ka band:** This use case concerns the provisioning of broadband communication to handheld device at the Ka band from LEO satellites for a complete integration of terrestrial systems that operate in the Ka band with their non-terrestrial counterparts. Towards this, distributed beamforming from LEO satellite swarms and high gain and energy-efficient antenna design at the terminal side will be leveraged.
- 3. Use case 3-Air-space safety critical operations:** This use case concerns the reliable connectivity through TN, HAP, and LEO satellite-based space network platforms to maintain persistent communications with air traffic controls and air operation centres along their routes connecting different airports.

FIRST RESULTS

The main results during the 1st year of ETHER concern the initial ETHER reference architecture that comprises the: i) Infrastructure layer; ii) End-to-end service layer consisting of the Network, Service, and Application

layers ; iii) Business layer; iv) End-to-end cross-domain ETHER MANO, coordinating the above-mentioned layers on multiple levels. This architecture is illustrated in the figure below.

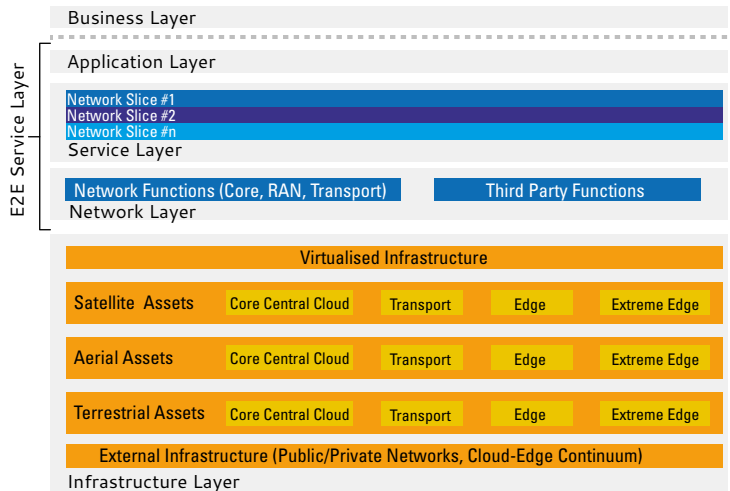

ETHER reference architecture.

*Self-evolving terrestrial/
non-Terrestrial Hybrid
nEtwoRks*



Coordinated by
Symeon Chatzinotas,
University of Luxembourg
January 2023–December 2025

Website: www.ether-project.eu/

X: @ETHER_eu

LinkedIn: www.linkedin.com/company/etherprojecteu/

Verticals concerned :Aviation

Project Consortium Members:
University of Luxembourg, Aristotle
University of Thessaloniki, Collins
Aerospace, Avanti Communications, SatelloT
Services, Ubiwhere, Fundació Privada
I2CAT, Nearby Computing, National Centre
for Scientific Research – “Demokritos”,
Linköping University,
Orange Poland,
Martel, Net AI Tech.



FLEX-SCALE

Future 6G networks will rely on large-scale deployments of smart MIMO antennas in both small-cells and cell-free RAN architectures.

OVERVIEW

The project developments enable flexible capacity scaling in a cost and energy efficient way by:

1. As shown in first figure, enhancing the convergence of UWB and SDM in networks, via implementation of a novel ≥ 10 Pb/s multi-granular optical node (MG-ON spectral and spatial degree of freedom), with a primary focus on exploitation of new wave-length bands across multiple spatial lanes utilising the WBSS capabilities.
2. Supporting evolution of single-fibre I/O interfaces of those switches and network terminals to 10 Tbps and beyond, via the replacement of power-hungry and bandwidth-limited

electronic digital-to-analog converters (eDACs) in ultra-high-speed transceivers with energy-efficient all-optical DACs (oDACs). These single-fibre, single-wavelength I/O interfaces can extend to Pbps capacity links using spectral and spatial multiplexing.

Considering new autonomous SDN control, streaming telemetry and ML-enabled data analytics architectures, and energy-efficient routing algorithms to optimise packet traffic flows over spectral and spatial optical channels, reducing even more the energy consumption while maintaining a low blocking probability.

CONCEPT/ARCHITECTURE

In first figure, the 6G network spans segments from the Radio Access Network (RAN) to the Core network. Traffic from RAN sites is directed via fronthaul to Aggregation Routers connected to the Optical Transport network through Optical Nodes (FLEX-SCALE). ONs at the network edge have lower capacity than those deeper into

the backbone network connecting to Metro and Core Routers. ONs route and manage traffic for each network segment, reducing router capacities and ports, thus saving energy and cost. Deeper into the core network, ON capacity exceeds 10 Pbps, with optoelectronic interfaces supporting rates from hundreds of Gb/s to ≥ 1 Tbps.

USE CASES/SCENARIOS

Based on three key requirements, which are latency, bitrate, and fibre density, we can classify the 6G services into seven categories. The proposed service classification scheme is illustrated in the following figure. We selected these three requirements as at least one of them is required for the vast majority of 6G services. This categorisation scheme for the 6G services is equivalent to the scheme that particularly focuses on the categories accessed via wireless access networks. This figure extends the scheme to include also 6G services

supported by the optical access part of the network. Both schemes complement each other in order to offer all 6G service categories to users at any point of the globe and regardless of the technology they exploit to access the network. In the FLEX-SCALE project, we are mainly focusing on developing novel technologies and components, such as the innovative transceiver and the Waveband Selective Switch (WBSS), to efficiently support service categories that generate a high amount of traffic, like the eFBB.

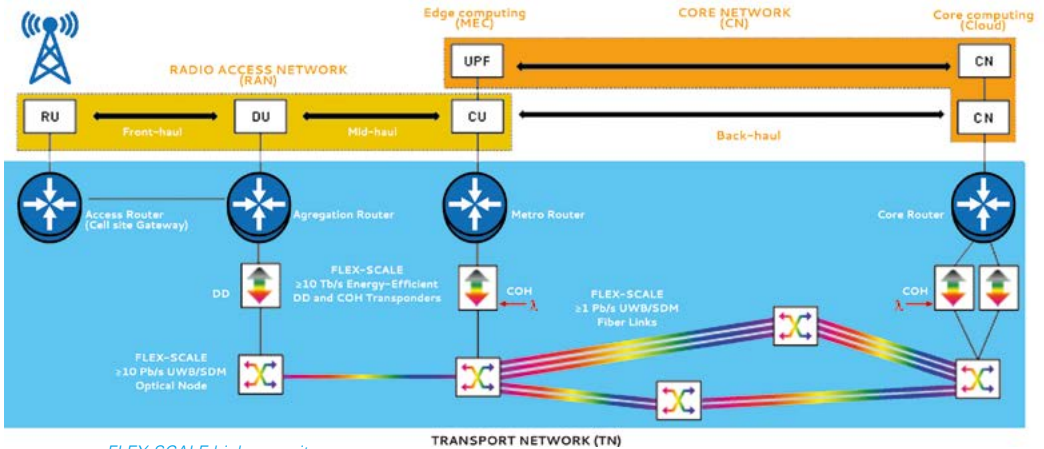

FLEX-SCALE high-capacity, UWB+SDM transport network for 6G

FIRST RESULTS

1. The availability of fixed back-haul and long-haul networks with performance levels
2. The availability of viable solutions, both from a technological and cost perspectives, allowing to bring beyond 5G and 6G services to places where terrestrial solutions are not economically viable, hence maximising coverage and access to services.
3. The availability of solutions addressing the need to develop 3D scalable networks capable to address flying devices, beyond current network solutions primarily designed for 2D usage.

6G, compared to its predecessor, is expected to offer significantly better communication capabilities, such as Tbps-level peak data rates, micro-second-level latency, and 99.9999% network dependability. Although 6G promises a lot, it is unlikely that 6G will be in daily life soon, despite the fact that several important companies and nations have already begun 6G research, as shown in the figure below, the telecom industry needs to address several issues before seeing the success of 6G.

Classification of services based on three requirements (latency, bit rate, and fibre density)

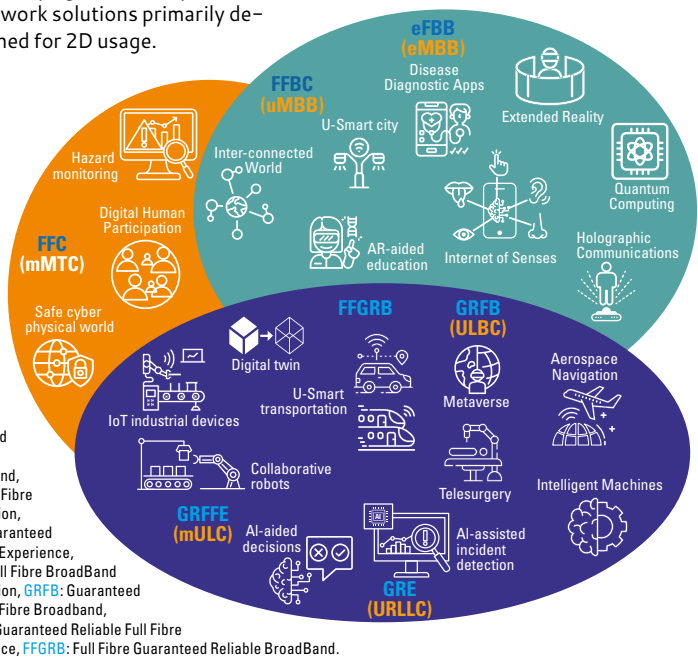

Flexibly Scalable Energy Efficient Networking



Coordinated by Ioannis Tomkos (University of Patras)

January 2023–December 2025

Website: 6g-flexscale.eu/

LinkedIn: www.linkedin.com/company/flex-scale/

Project Consortium Members: University of Patras, CNIT, Huber + Suhner, Fraunhofer HHI, the Hebrew University of Jerusalem, LioniX International, Opsys Technologies, PiCadvanced, Ericsson, Telefonica I&D, Polariton Technologies, UBITECH, VPIphotonics, Federal Institute of Technology Zurich



HEXA-X-II

Hexa-X-II is the SNS 6G flagship project, providing a holistic view of the concepts and enablers to define a 6G end-to-end system that will deliver the future 6G digital services.

OVERVIEW

The Hexa-X-II project is the European 6G flagship project, as part of the SNS JU Stream-B Call#1. The main goal of the project is to develop and describe a holistic view of the end-to-end (E2E) system platform, incorporating technical components and enablers from within the project, as well as from other SNS JU projects.

As a flagship project, Hexa-X-II intends to interact with all other SNS JU projects through a series of workshops to be able to formulate the European view of 6G.

The project consortium consists of 35 partners with a total of 44 legal entities.

ARCHITECTURE

Hexa-X-II has released an initial version of the E2E system blueprint as can be seen in the figure below. Expanding on the 5G architecture, the infrastructure layer incorporates e.g., compute and storage in a cloud continuum; the network functions layer is expanded with beyond-communication functions (e.g., sensing compute); and a new Network-centric application layer is introduced that can expose the network functionalities to outside the network.

Building on the work from Hexa-X, Hexa-X-II will further elaborate on the three aspects of sustainability, environmental, social, and economic.

Furthermore, the Hexa-X-II project is working on technical enablers for architecture (e.g., data-driven architecture or network modularisation), 6G radio (e.g., sub-THz joint communication and sensing and spectrum access) 6G devices (e.g., energy natural devices), and smart network management & orchestration (e.g., intent-based management).



Coordinated by
Mikko Uusitalo (Nokia)
January 2023–June 2025
Website: www.hexa-x-ii.eu
X: twitter.com/Hexa_X_II
LinkedIn: www.linkedin.com/company/hexa-x-ii/

Project Consortium Members:
Nokia, Ericsson, Aalto University, Apple, ATOS, CTTC, Chalmers University of Techn., ICCS, IMEC, Luleå Techn. University, TNO, Nextworks, One Reality, Optare Solutions, Orange, Oulu University, PIU, Qamcom, Qualcomm, SAS IDATE, Sequence, Siemens, Sony, TU Dresden, VTT, Telecom Italia, Telefonica, Telenor, Ubiwhere, UC3M, Vodafone, WINGS, Barkhausen, NXP, Rheinland-Pfälzische Techn. University.



6G end-to-end blueprint

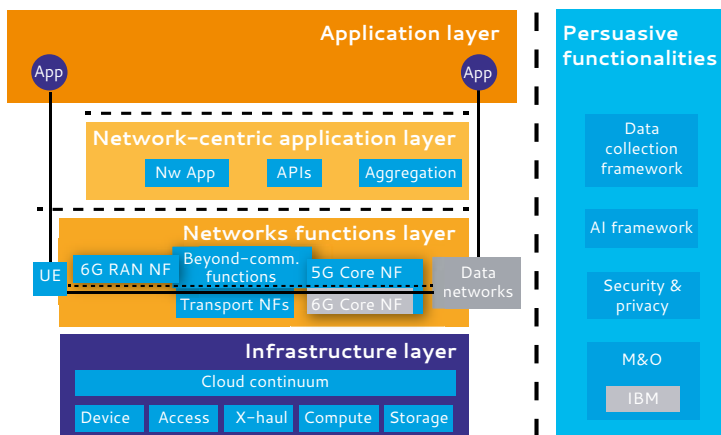

USE CASES/ SCENARIOS

Building upon the work from Hexa-X, Hexa-X-II has further developed the 6G use cases and introduced 6 use case families, each with a representative use case.

Immersive Experience: Seamless Immersive Reality goes beyond the 5G XR application and will enable seamless interactions with physical and digital objects on a massive scale.

Collaborative Robots: Cooperating mobile robots will leverage on the AI revolution and provide reliable connectivity for autonomous robots.

Physical awareness: Network-assisted mobility, as 6G becomes a network platform, not only delivering data, but also generating information, such as sensing spatial data. This will allow to provide a user with enhanced awareness of the surroundings.

Digital Twins: Real time digital twins will provide an accurate digital representation of any combination of processes, products, persons and functionalities of a real-world items in e.g., industry or smart cities, and 6G will be able to provide low-latency updates of the digital twin.

Fully connected world: Ubiquitous network, the digital divide remains a major hurdle to overcome global poverty. By enabling ubiquitous access to the 6G networks, the digital services will be afforded to everyone on the globe.

Trusted environments: Human-centric services. As more and more data are being collected, the requirements for utmost security and privacy increases. This is of particular importance for use cases concerning the human body, e.g., monitoring health vitals, to ensure that the data cannot be misused.

Hexa-X-II Use Cases with Highlighted Representative Use Cases

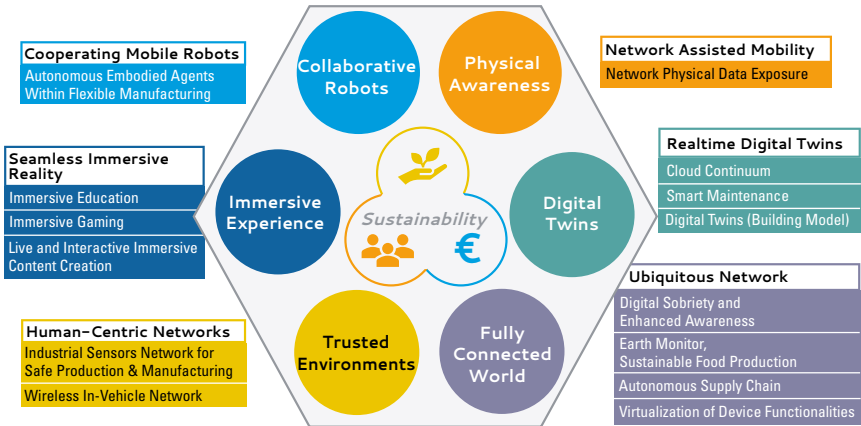

FIRST RESULTS

Hexa-X-II aims to provide a holistic view of the concepts and enablers required to define the 6G E2E system, ahead of the technical standardisation which will commence in 2025. The main impact of 6G will be to transform it from a network to a platform, that can provide efficient and flexible services beyond communication. To allow efficient operation, fully leveraging on automation and AI, the 6G system should enable exposure of

capabilities that will allow innovation across the platform. The project will also showcase the E2E system with a series of PoCs, incorporating aspects of management and orchestration, flexible topologies, 6G devices, and 6G radio aspects. The first iteration of the PoC shows significant improvements in operation with dynamic functional placement for an autonomous industrial robot use case.

HORSE

HORSE proposes a novel human-centric, open-source, green, sustainable, coordinated provisioning and secure evolutionary platform.

OVERVIEW

The 6G vision of HORSE is towards an omnipresent, smart and secure network service provisioning in the future network-of-networks landscape. To this end, HORSE proposes a novel human-centric, open-source, green, sustainable, coordinated provisioning and protection evolutionary platform, which can inclusively yet seamlessly combine advancements in several

domains, as they get added to the system (e.g., predictive threats detection, proactive business-wise threats and breaches mitigation actions, programmable networking, semantic communications, Network Function Virtualisation (NFV), intent-based networking, AI-based techniques, cross-layer management of physical layer features, etc.).

USE CASES/ SCENARIOS

HORSE proposes a validation strategy supported by pilots deployed on two real use cases, as described next. For each individual use case, the background and main scenarios highlight what the overall context is, as well as the benefits from the use cases perspective driven by a potential HORSE deployment.

Use Case 1: Secure Smart LRT Systems (SS-LRT)

Background: LRT (light Rail Transit) or Metro Operation involves the management and orchestration, with high availability, of several systems, applications, and end to end services, supported by equipment that typically are deployed on tram stops, trams and in the Command Centre. Usually, these Command Centres are deployed in private networks, for security reasons and are in the Operator premises, for latency reasons. The 6G capabilities, particularly the ones that are addressed in the HORSE project, will leverage the introduction of new paradigms related to communications, disaster recovery, security, resilience, with geographically and distributed operation (even supported by cloud solutions) with several impacts in the overall availability and in the decision support.

Main scenarios: based on Dublin and Bergen LRT/Metro scenarios, deployed by EFACEC, it is intended to compare the system performance that is being achieved now with the one achieved by HORSE solution, regarding the following main performance objectives:

- Disaster recovery
- Remote operation, including cloud solution
- Operation statistics
- Security vulnerabilities and threats
- Communication performance for data exchange between trams, stops and the Command Centre
- Applications and services performance

Use Case 2: Remote Rendering to Power XR Industrial (R22XRI)

Background: Multiuser XR (Extended Reality) multi-sites collaboration provides Industry 4.0 professionals with the means to solve complex issues in a much easier and efficient way, giving them the opportunity to meet in a virtual common space to collaborate and share virtual 3D objects. Furthermore, and most importantly, thanks to VR and AR, processes can be monitored and experienced in 3D for future research.

Yet, to provide a reliable and secure communication system (as backbone for information exchange), even more when the collaboration is among different sites, is an emerging challenge to be faced. Industrial espionage is a growing threat, forcing manufacturers to take a more proactive approach to securing their intellectual property. A proactive, resilient, and secure system is extremely important to protect valuable data and intellectual property from unauthorised access ensuring a free flow of information throughout all actors involved (engineers, specialists, and supply chain). Thus, virtual remote collaboration, security, in the communication improvement and process monitoring are key challenges that this pilot use case aims to explore.

Main scenarios: the HORSE project will develop and operate a multiuser

environment where different professional stakeholders can interact and teleport to another context that is completely virtual or mixed. The service will offer a resilient and secure environment, professional users located at different sites and leveraging XR technology can benefit from. The main characteristics will be:

- Endless cloud and edge processing power to stream big data
- Global availability on all XR devices
- High data sharing security with regarding to peer-to-peer communication, human-machine interaction and 3D assets sharing
- Infrastructure flexibility
- Fast Adoption by simple integration
- Empowering teams with efficient app development & time-savings

FIRST RESULTS

A first phase of the project was to carefully define two specific scenarios: Secure Smart LRT Systems (SS-LRT) and Remote Rendering to Power XR Industrial (R22XRI). These use cases were described, their problem statements are analysed in relation to the HORSE infrastructure, and the corresponding requirements were derived.

By analysing those requirements, the second phase mainly focused on releasing an initial version of the architecture and the functional design of the HORSE platform. The HORSE architecture is split into three main layers:

- The Intent-based Interface (IBI) aims to simplify the network configuration and operation by receiving high-level intents from the network manager or software agents. Based on advanced IA techniques, the IBI module proposes policies to be applied to the network to fulfil the received intents.
- The second layer, the Platform Intelligence (PIL) module, adds intelligence and autonomy to the network management, including sub-modules that can predict the behavior of the network before reconfiguring the network. The PIL module relies on sub-modules capable of detecting and reacting

to network security threats. PIL technology is based on the development of Network Digital Twins.

- Finally, the third layer, the AI Secure and Trustable Orchestration (STO) module, enables reliable network operation by assuring correct orchestration of the network resources and execution of policies proposed by the IBI layer. This module also includes advanced monitoring mechanisms required in the 6G scenario.

New components were introduced due to the need to consider two different contexts, one real and another emulated, working in distinct time windows.

Two different workflows were described to study the functional behavior of each HORSE module and the interaction among them. The first workflow aims to detect and mitigate threats in the network by gathering data from the real infrastructure. The second workflow is based on AI, and it employs digital twinning techniques to predict and prevent threats using a sandboxed and emulated environment.

The interactions from two real use cases to the newly proposed architecture are then analysed to describe their interactions with the HORSE components.

*Holistic, Omnipresent,
Resilient, Services for
future 5G Wireless and
Computing Ecosystems*



Coordinated by
Fabrizio Granelli (CNIT)
January 2023–December 2025

Website: www.horse-6g.eu/

X: twitter.com/HORSEProjectEU

Linked In: [horse-project-eu/](https://www.linkedin.com/company/horse-project-eu/)

Project Consortium Members:
CNIT, Atos, Telefonica, Ericsson, Technical University of Braunschweig, National and Kapodistrian University of Athens, Suite5, Polytechnic University of Catalonia, Martel, Efacec, HOLOLIGHT, ZORTENET, Sphynx Technology Solutions, 8BELLS, University of Murcia.



PREDICT-6G

PREDICT-6G aims to create a deterministic 6G solution with seamless service delivery for vertical use cases, using novel technology and AI-driven control planes to ensure reliability and time sensitivity in network operations.

OVERVIEW

As part of SNS JU Phase 1 projects on evolutionary 5G, 6G exploration, concepts, definitions, PREDICT-6G's mission is focused on the development of an end-to-end (E2E) 6G solution, including architecture and protocols capable of ensuring seamless service delivery for vertical use cases, requiring extremely tight timing and reliability constraints. To succeed, the solution will target determinism network infrastructures at large, including wired and wireless segments and their interconnections.

PREDICT-6G will develop a novel Multi-technology Multi-domain Data-Plane (MDP) overhauling the reliability and time sensitiveness design features existing in current wired and wireless standards. The ambition is for the MDP design to be inherently deterministic. To achieve this, PREDICT-6G will develop an AI-driven Multi-stakeholder Inter-domain Control-Plane (AICP) for

the provisioning of deterministic network paths to support time-sensitive services as requested by end-customers and with different scaling ambitions. This requires timely monitoring and prediction of the behaviour of the complete network, including identifying potential sources of quality violations and analysing various routes of the traffic flows. These capabilities will be delivered through PREDICT-6G's AI-powered Digital Twin (DT) framework, which will enable prediction of the end-to-end network infrastructure behaviour and early control and validation of network arrangements to meet the actual reliability and time-sensitivity requirements of the services in operation.

Within the SNS JU Phase projects, there are two sister projects of PREDICT-6G: DESIRE6G and DETERMINISTIC6G.

CONCEPT/ARCHITECTURE

The aim of PREDICT-6G is to provide technology enablers and management automation for multi-domain end-to-end deterministic services. In this context, domains may mean both technological domains (i.e., network segments implemented with different communication technologies such as 3GPP, IP, TSN, Wi-Fi, etc.) and administrative domains (i.e., domains that are governed by separate entities, although they may or may not be realised with the same network technology). Determinism means to provide predictable, reliable and time

sensitive data transfer between the communicating endpoints, where, according to the multi-domain principle, the endpoints may be part of or attached to different technological or administrative domains. Finally, management automation means to provide technological components that orchestrate the process of provisioning and configuring end-to-end deterministic services, and to take proactive predictive actions during the lifetime of the services to ensure that the end-to-end deterministic targets are continuously met.

USE CASES/ SCENARIOS

The different features developed within the project, specifically the MDP and AICP, will be validated in three use cases, carefully selected to represent application needs and relevant technological gaps.

Deterministic services for critical communications: This use case tests PREDICT-6G's multi-domain autonomous deterministic network for devices requiring deterministic group communication, such as in cloud robotics and vehicular scenarios. The MDP ensures reliable communication for dynamic groups of vehicles, continuously adapting to their mobility by managing endpoints dynamically.

Multi-domain deterministic communication: PREDICT-6G will showcase extending deterministic communications to large multi-provider scenarios, using a mix of

control and data-plane mechanisms for timely services. The MDP employs technologies like WiFi, 3GPP, TSN, Flexible Ethernet, DetNet (Deterministic Network), and network programmability to ensure bounded latency and reliability across diverse networks. The aim is to experiment and develop techniques for scaling deterministic approaches effectively in multi-domain scenarios.

Smart Manufacturing: Our partner GESTAMP has been committed to Digitisation and Industry 4.0 for several years, with a clear vision: to transform its current manufacturing model towards the model of the future smart manufacturing plant, providing wireless access with deterministic characteristics to robots controlled in the cloud, using the innovations on disaggregated architectures expected in 6G.

FIRST RESULTS

The project's envisioned outcomes include designing a deterministic 6G network, enhancing reliability in different technology domains, developing an AI-based control-plane framework for multi-stakeholder 6G environments, testing the system architecture, and disseminating results widely through Open Science practices and impact standards.

The project completed the use case definition, requirement analysis and detailed reference architecture specification of PREDICT-6G, resulting in a system definition that can be adapted to different network technologies, physical/virtual devices, HW/cloud/compute infrastructure, and lab environments. On the data plane, the project identified and specified technical enablers of creating cross-domain deterministic services – such as deterministic service continuity

at domain borders, deterministic scheduler designs, cross-domain split of reliability and deterministic enablers, means of time sync across multiple domains. Programmability of the data plane enablers were framed in a modular and extendible OpenAPI framework wrapping technology specific deterministic capabilities into technology agnostic control/management plane services to enable the composition of e2e deterministic services spanning multiple domains and technologies. The project defined the information model for e2e deterministic services and the e2e-domain level service continuum, which allows the segmentation of e2e deterministic service requirements to domain level responsibilities by considering the capabilities and resources present in the constituent network domains.

*PR*ogrammable
AI-Enabled *Deterministic*
*neT*working for 6G



Coordinated by
Antonio de la Oliva Delgado
(University Carlos III of Madrid)
January 2023–December 2025

Website: www.predict-6g.eu

X: twitter.com/Predict6G

Verticals concerned

Industry, manufacturing, mobility,
critical communications, media and
entertainment

LinkedIn: [www.linkedin.com/
company/predict-6g-project/](https://www.linkedin.com/company/predict-6g-project/)

Project Consortium Members:
University of Carlos III de Madrid, Atos
Solutions and Services Spain and Atos
Spain, Cogninn, Consiglio Nazionale
delle Ricerche, Ericsson Spain, Gestamp
servicios, Intel Germany, Interdigital
Europe, Australo, Nextworks, Nokia
Solutions and Networks Hungary,
SIMAVI, Telefonica, Polytechnic
University of Turin



PRIVATEER

PRIVATEER is to pave the way for 6G “privacy-first security” by studying, designing and developing innovative security enablers for 6G networks, following a privacy-by-design approach.

VISION

PRIVATEER aims to enhance 6G networks’ security through its innovative solutions, following a privacy-by-design approach. PRIVATEER offers a set of security enablers, focusing on **XAI-driven, privacy-preserving security analytics, decentralised management with user-defined**

privacy intents, and robust distributed attestation and identification mechanisms. By unifying these elements in a comprehensive framework and testing in a B5G context, PRIVATEER seeks to set a new benchmark for privacy and security in future 6G networks.

CONCEPT/ARCHITECTURE

PRIVATEER’s Security and Privacy-Enabling Framework consists of several layers, each comprising distinct components that interact with each other to secure the network from attacks while preserving end-users’ privacy, as shown in the figure below.

Specifically, PRIVATEER’s architecture is based on four major pillars:

- **Privacy-Aware Orchestration:** AI-driven mechanisms and blockchain technology are used for VNF placement and trust assessment. Proof of Transit (PoT) mechanisms ensure traffic integrity and order, enhancing network trustworthiness.
- **Security Analytics:** The Edge Domain enhances performance

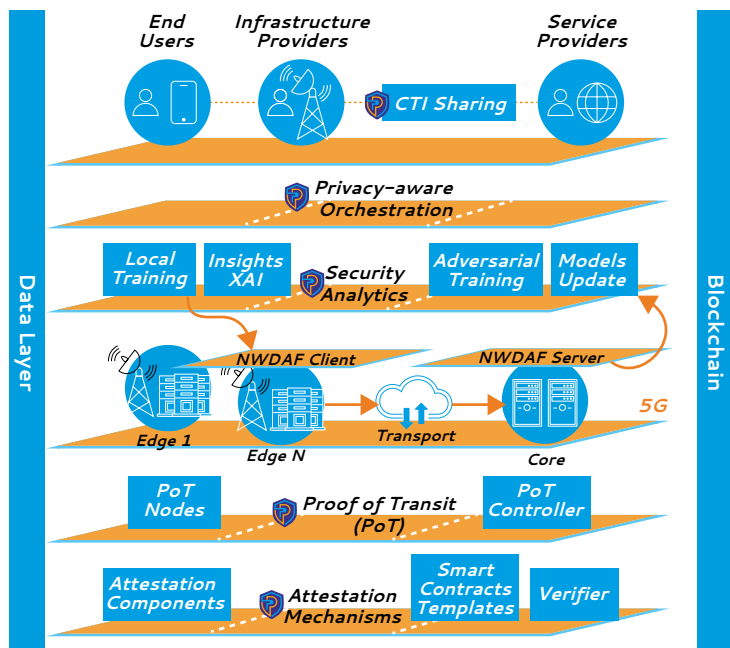

through FPGA accelerators and utilises Network Data Analytics Functions (NWDAFs) in a federated learning deployment for intrusion and anomaly detection, ensuring data privacy.

- **Remote Attestation:** Bootup and runtime attestation mechanisms verify virtualised environments and maintain system integrity. Distributed Identification

introduces Verifiable Credentials (VCs) and Decentralised Identifiers (DIDs), registered on a Distributed Ledger, to authenticate users without third-party reliance.

- **Cyber-Threat Intelligence (CTI) Sharing:** Establishment of a network for confidential and efficient threat data exchange among stakeholders, utilising a secure, distributed index and proxy system.

USE CASES/ SCENARIOS

The PRIVATEER framework addresses critical security and privacy challenges across Intelligent Transport Systems (ITSs) and Smart Cities, focusing on safeguarding private networks, orchestrating secure logistics, and enhancing public transportation with privacy-centric solutions. For road operators, the framework enables robust defences against edge service compromises through advanced detection and AI-driven analytics. Logistics operations benefit from secure network resource orchestration, leveraging PRIVATEER's privacy-preserving mechanisms to ensure data integrity and secure communications. In the field of public transportation,

a citywide network slice supports privacy-secure journey planning and AI-assisted functionalities, illustrating the framework's utility in managing sensitive data across multiple service providers.

Smart city initiatives include the deployment of a "neutral host" edge network by a municipality, emphasising the importance of infrastructure integrity and the need for distributed analytics to prevent security breaches. Additionally, a startup's smart city application across two cities showcases the necessity of multi-domain infrastructure verification and Proof of Transit to maintain the confidentiality and integrity of sensitive data.

EXPECTED RESULTS

By the end of the project, PRIVATEER will have delivered a set of software enablers for privacy-first security in 5G/B5G networks. These include: i) federated learning-based multimodal intrusion detection techniques, hardened against adversarial actions ii) Explainable Artificial Intelligence (XAI) tools and techniques to communicate threats, iii) streaming pipelines for data anonymisation, iv) trusted and secure hardware acceleration platforms for Federated

Learning (FL), v) open annotated datasets for Machine Learning (ML) testing, vi) an intent-based manager tool for privacy preservation, vii) a privacy-aware orchestrator, viii) privacy-aware proof-of-transit mechanisms, ix) privacy-preserving CTI sharing mechanisms, x) Decentralised Identifiers for securing the 6G ecosystem. The project will also deliver reports related to 6G threat landscape, use cases evaluation and threat modelling of the developed tools.



Coordinated by
Georgios Gardikis,
Space Hellas S.A.

January 2023–December 2026

Website: www.privateer-project.eu/

X: twitter.com/Privateer_6GSNS

LinkedIn: [www.linkedin.com/
company/privateer-6gsns/](https://www.linkedin.com/company/privateer-6gsns/)

Verticals concerned :
Transport and logistics, Smart Cities

Project Consortium Members:
Space Hellas S.A., NCSR "Demokritos",
Telefónica I&D., RHEA System., INESC
TEC, Infilii Technologies PC, Ubitech,
Complutense University of Madrid, the
Institute of Communication and Computer
Systems, the Norwegian Defence
Research Establishment, Iquadrat R&D,
Polytechnical
Institute of Porto,
ERTICO-ITS Europe.



RIGOUROUS

The RIGOUROUS project aspires to identify and address the major cybersecurity, trust and privacy risks threatening the network, devices, computing infrastructure, and next generation of services.

OVERVIEW

The RIGOUROUS project addresses cybersecurity, trust, and privacy risks in the 6G network, devices, computing infrastructure, and next-gen services. It will introduce a human dimension to future networks by considering security and privacy aspects, coupled with a new smart service framework that uses ML and AI mechanisms to

implement cognitive SOAR loops that react dynamically to ever-changing threats.

The project salutes SNS JU initiatives, having participated in events and envisioning cooperation with other initiatives such as HORSE, PRIVATEER, and HEXA-X-II.

CONCEPT/ARCHITECTURE

The framework will ensure a secure, trusted, and privacy-preserving environment for the next generation of trustworthy continuum computing 6G services across different networks, as shown in the figure. The DevOps lifecycle will prevent and detect anomalies or intrusions and enforce policies. A transition to "DevSecOps" will ensure a secure, continuous delivery and integration framework in large-scale digital production environments. Automation and dynamic orchestration will be used for ease of operability and management, while the human factor will be incorporated in the design and orchestration. Advanced security enablers will also be developed to bring automation and intelligence to the

secure orchestration concept. In brief, RIGOUROUS targets the following key objectives:

1. Holistic Smart Service framework for securing the IoT-Edge-Cloud continuum lifecycle management;
2. Human-Centric DevSecOps;
3. Model-based and AI-driven Automated Security Orchestration, Trust Management and deployment;
4. Advanced AI-driven Anomaly Detection, decision, and Mitigation Strategies;
5. Demonstration of a Set of Industrially Relevant Use Cases in Operational Environments.

USE CASES/SCENARIOS

- **UC1 - RIGOUROUS Platform Validation:** This use case centres around the Orange Romania lab and validates the platform's capability to enhance the flexibility of future telco infrastructures. Addressing the transformative challenges of 6G, it employs a DevSecOps approach to integrate security into the development lifecycle. It assesses performance through three threat scenarios, confirming the

platform's effectiveness in identifying, responding to, and mitigating complex cyber threats to vital 6G infrastructures.

- **UC2 - IoT-Based Smart City Platform:** A cloud-native IoT platform for smart city applications with extensive twinning capabilities. It manages diverse IoT data from gateways spread across the city, supporting various communication

RIGOUROUS
Reference Architecture

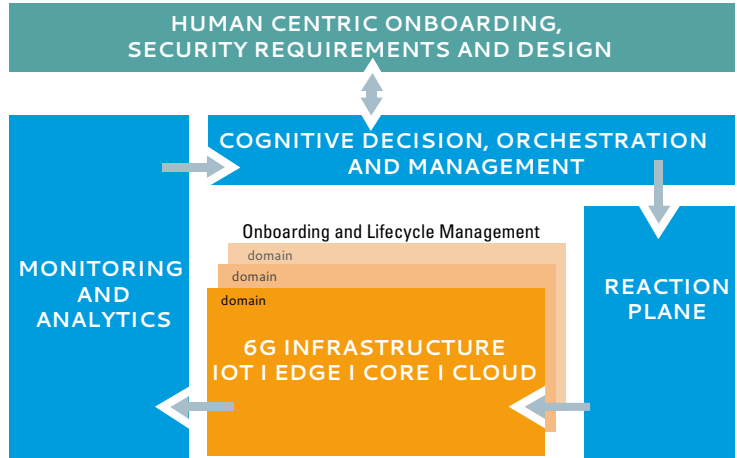

- technologies and devices. Threat scenarios, such as unauthorised communications and economic DoS, are to be examined, emphasising correlations with critical assets.
- **UC3 – Utilities Management and Security:** This in-depth examination focuses on the data security of utilities management. Threat scenarios also encompass DDoS attacks, code and data injection, and challenges posed by outdated systems.
- **UC4 – Public Protection and Disaster Relief (PPDR):** Scenarios involving PPDR scene and team provisioning, potential intrusions, and disclosure of device vulnerabilities. This case highlights the correlations between assets and critical elements that are at risk.

FIRST RESULTS

RIGOUROUS has produced several enablers to support security and privacy in 6G networks, with several publications and five deliverables documenting the use cases and design plans (see results at <https://rigorous.eu>). RIGOUROUS also organised workshops at international

conferences and promoted its advancements and cybersecurity practices in speaking events. Partners are currently targeting an important milestone by demonstrating the first proof of concepts, technology demonstrators, and solutions.

*secuRe desiGn
and depLOyment of
trUsthwoRthy cOntinUum
computing 6G Services*



*Coordinated by
Antonio Skarmeta Gomez
(University of Murcia)
January 2023–December 2025*

Website: <https://rigorous.eu>

X: twitter.com/RigorousEU

*LinkedIn: [www.linkedin.com/
company/6gsns-rigorous/](https://www.linkedin.com/company/6gsns-rigorous/)*

*Verticals concerned :
Smart Cities, PPDR*

*Project Consortium Members:
University of Murcia, Orange Romania,
Lenovo, RHEA Group, EBOS Technologies,
WINGS-ICT, OneSource, ICT-FI, University
of Oulu, Instituto de
Telecomunicações,
and University of
the West of Scotland.*



SUPERIOT

SUPERIOT aims at demonstrating, advocating and further promoting the concept of truly sustainable IoT systems.

OVERVIEW

SUPERIOT aims to develop a truly sustainable and highly flexible IoT system based on the use of optical and radio communications, and the exploitation of printed electronics technology for the implementation of sustainable IoT nodes. The dual-mode optical-radio approach confers unique characteristics to the IoT system. The system can be dynamically reconfigured to use optical, radio, or both connectivity approaches. The hybrid optical-radio system allows very efficient use of resources while combining the advantages of both wireless communication methods. Energy autonomous nodes will be designed to harvest energy from both light and radio sources, resulting in an efficient and reliable energy system. Moreover, positioning reliability and accuracy will also be improved by jointly

exploiting optical and radio signals. The implementation of the IoT nodes will use as much printed electronics technology as possible, resulting in a cost-efficient, environmentally friendly solution. Nodes will have essential IoT functionalities such as sensing, actuating and computational capabilities. As important as the development of a sustainable and flexible IoT node will be the development of its networking capabilities. The project will also identify, develop, and demonstrate applications for the proposed concept. As a proof-of-concept, the SUPERIOT project will develop four demonstrators.

SUPERIOT actively disseminates its activities, sharing research areas with 6G SNS partner projects such as 6G Shine, 6G Tandem, and HEXA-X-II.

PROJECT OBJECTIVES AND VISION

Key characteristics of the SUPERIOT concept

The project will create an IoT system that is sustainable from multiple perspectives, advocating three principles: 1) sustainable by design, 2) sustainable by implementation and 3) sustainable by usage. SUPERIOT will use multimodality in several domains, using light

and radio signals to provide wireless connectivity, to harvest energy and to provide positioning. Reconfigurability will be a key characteristic of the concept. Both nodes and the network can be dynamically reconfigured to create a versatile system that is adaptable to the

Sustainability by design

Multi-mode communications: light-and radio-based wireless connectivity
Multi-mode energy harvesting: light-and radio based
Multi-mode positioning: light- and radio-based
Reconfigurability: node and network

Sustainable implementation: printed electronics technology (node)
Sustainable use: smart energy harvesting and management batteryless IoT nodes, reconfigurability
Sustainable disposal: printed electronics technology (node)

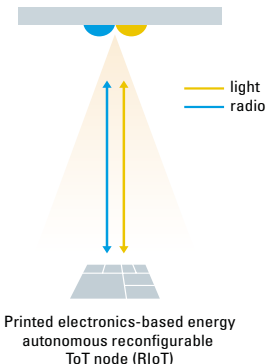

dynamics of the environment as well as to different operating scenarios. Since IoT in general involves the massive use of nodes or devices, particular care will be put in designing highly sustainable

IoT nodes. The project will consider energy autonomous IoT nodes (i.e., battery-less) that are implemented with environmentally friendly technology such as printed electronics.

DEMONSTRATORS

Truly Sustainable Printed Electronics-based IoT Combining Optical and Radio Wireless Technologies



Coordinated by Tuomas Paso and Marcos Katz (University of Oulu)

January 2023–December 2025

Website: superiot.eu

X: twitter.com/superiot.eu

LinkedIn: www.linkedin.com/company/superiot

Verticals concerned:

Smart Energy, Industry 4.0, manufacturing

Project Consortium Members:

University of Oulu, INESC TEC, VTT, FCT NOVA, IMEC, LIGHTBEE, MPICOSYS-Embedded Pico Systems, Catholic University of Leuven, Vivid Components Germany UG, Wavocom Solucoes Radio, University of Bristol



Demonstrators of the SUPERIOT project

Four demonstrators will be developed: a) reconfigurable optical-radio IoT node implemented with printed and conventional electronics technologies (application: smart tags and labels); b) reconfigurable optical-radio IoT network (application: logistics in medical ICT scenarios); c) limited capability IoT node implemented with

printed electronics technology only, and d) large-area IoT node/repeater. These demonstrators will prove the project's unique holistic approach to developing truly sustainable IoT systems based on three principles: sustainable by design, sustainable by implementation and sustainable by usage.

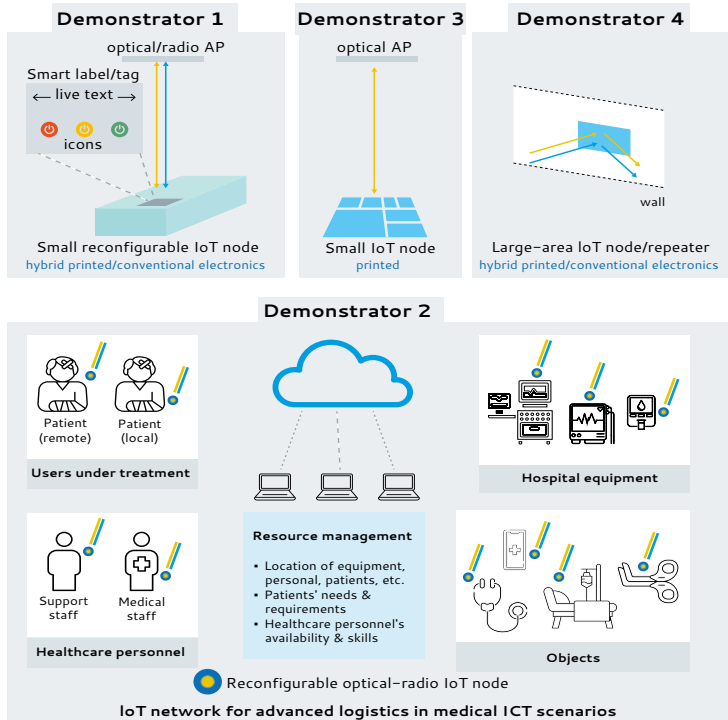

EXPECTED RESULTS

As the project progresses, we anticipate a) fully printed reconfigurable optical-radio IoT nodes; b) extremely inexpensive nodes for mass-markets; c) use of biodegradable electronics for environmentally friendly nodes;

d) nodes and networks with enhanced capabilities and e) operation in novel scenarios (e.g. inside the human body, underwater, mining) and massive sensing and actuation.

TERA6G

TERA6G is advancing connectivity with cutting-edge transceivers.

OVERVIEW

TERA6G goal is to develop wireless transceiver modules and network management concept that can pave the way towards Terabit-per-second wireless links. The aim is to unlock the access to the frequency bands above 100 GHz and enable massive multiple-input multiple-output (mMIMO) multi-antenna techniques to offer extremely high transport connectivity to multiple distant locations. For this, we use integrated photonic mmW/THz technologies. Photonic mmW/THz generation gives flexibility to these modules,

enabling for example to operate in any band of the electromagnetic spectrum, ranging from the microwave to the millimeter-wave and the Terahertz bands as well as unlock multi-element antenna arrays. This technology can be widely used in various situations, such as outdoor hotspots, drone platforms, and disaster recovery.

The project leverages on expertise gained from several past THz-oriented Horizon 2020 projects in which TERA6G project consortium partners were involved.

CONCEPT/ARCHITECTURE

TERA6G develops technologies in areas that are crucial for 6G networks. These include ultra-high frequency, wide bandwidth tunable radio transport, multi-beam and beamforming/steering concepts, flexible transport solutions, and end-to-end network architectures. The impact objectives include contributions to new standards, improving user throughput and network capacity, integrating mobile objects into network architectures, and supporting diverse types of service-level agreements and network slicing. The impact of these modules is to unlock two key concepts:

- **“Fibre over the air”** concept, using photonics-based technologies to reach the higher end of the electromagnetic spectrum – the Terahertz range – where bandwidth is available to prove the data capacity of fibre over a wireless link, and
- **“Smart management”** concept, using photonic components broad bandwidth and reconfigurability to enable network slicing functionality aiming at dynamic automated management of multi-beam wireless system resources, fully programmable end-to-end orchestrated communication networks.

USE CASES/SCENARIOS

The TERA6G research project seeks to develop versatile and scalable wireless transceiver modules that tackle complex connectivity challenges. To set the bar high, TERA6G focuses on some challenging communications scenarios, such as:

- deployment of small cells in high-traffic tourist areas, notorious for their limited network coverage due to dense user populations,

enabling increased throughput wireless connectivity to core network macro sites that avoid deploying fibre to the small cells,

- and modern factories that enhance automation deploying massive numbers of IoT devices in their production lines to boost efficiency and streamline operations enabling flexible production lines that reorganise the order of stations along the line.

From bustling tourist hotspots and crowded events to IoT-centric factories, TERA6G's solutions are poised to drive advancements in wireless communication and lay the foundation for the future of 6G networks.

By overcoming unique challenges in these dynamic environments, TERA6G demonstrates its commitment to re-shaping the wireless landscape for engineers, experts, and executives in the industry.

Densified mobile network scenario combining macro sites and small cells.

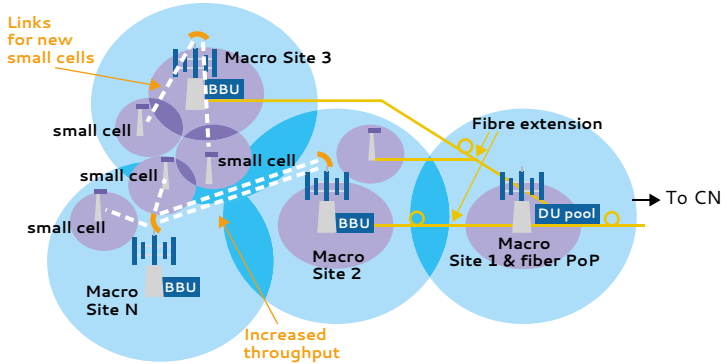

FIRST RESULTS

A key challenge of the targeted photonic-based wireless transceiver modules is their novelty and complexity. These module's novelty comes from avoiding dielectric silicon hyper-hemispheric lenses, common in Terahertz emitters, which block steerable antenna. Instead, using dielectric rod waveguide antennas to couple out the radiation from each antenna element. The complexity comes from the large number of elements that need to be hybridly integrated together in these photonic integrated transmitter and receiver

antenna array modules. Each antenna is driven by a high-speed photodiode in the transmitter or photoconductors in the receiver, allowing the module's broad operating frequency range. However, this requires complex waveguide routing network with reduced number of crossings, using a novel approach based on PolyBoard proprietary multi-layer waveguide platform. We have recently achieved the fabrication of the 4x4 photonic-driven antenna arrays.

*TERA*hertz integrated systems enabling 6G Terabit-per-second ultra-massive MIMO wireless

TERA6G
TERAHERTZ FOR 6G

Coordinated by
Guillermo Carpintero
(University Carlos III of Madrid)

January 2023–June 2026

Website: www.uc3m.es/research/tera6g

X: twitter.com/TERA6G

LinkedIn: www.linkedin.com/in/tera6g-project/

Project Consortium Members:
Telefónica, Intracom Telecom, Lionix, PHIX, CumuCore, Fraunhofer HHI, University of Carlos III de Madrid, National Technical University of Athens, University of Piraeus, University of Dulu

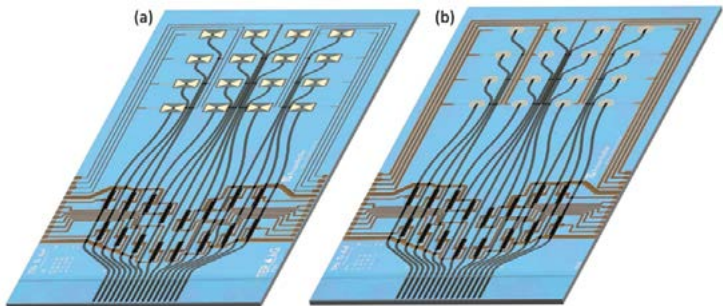

Indium Phosphide integrated 4x4 antenna arrays driven by high-speed photodiodes (a) Bow-tie array, and (b) Log-spiral array.

TERRAMETA

TERRAMETA aims to examine revolutionary 6G technologies and demonstrate the feasibility of multi-functional THz reconfigurable intelligent surfaces (RISs) to support very high data rates in wireless communications networks.

OVERVIEW

TERRAMETA is positioned within the Radio Access Network (RAN) pillar of the SNS programme, focusing on the development of Terahertz (THz) network architectures, components, and devices, as well as physical-layer signal processing algorithms and channel modelling for THz systems.

TERRAMETA has partnered with the SNS Phase 1 6G-SHINE and TIMES 6G projects to facilitate the exchange of research findings. Our recent activity

includes organising a special session on “Key challenges for enabling high-performance short-range communications in extreme propagation environments” at IEEE Conference on Standards for Communications and Networking (CSCN 2023), and a paper to be presented at IEEE European Conference on Antennas and Propagation (EuCAP) 2024 titled “Reconfigurable Intelligent Surfaces for THz: Hardware Design and Signal Processing Challenges”.

CONCEPT/ARCHITECTURE

THz frequencies constitute one of the most compelling, attractive, and promising frequency bands for future wireless communications supporting potential data rates of up to 1 Tbps, thanks to the large bandwidth available. TERRAMETA is developing ground-breaking THz technologies enabling the next generation of high-speed wireless communications and sensing/localisation applications.

One major contribution of TERRAMETA lies in the design and fabrication of Reconfigurable Intelligent Surfaces (RISs) operating at 140 and 300 GHz. RISs are expected to overcome the limitations of THz communications, i.e., blockage sensitivity and high path loss, by favorably shaping electromagnetic waves to create enhanced virtual Line of Sight (LoS) paths.

Scenarios and use cases of TERRAMETA

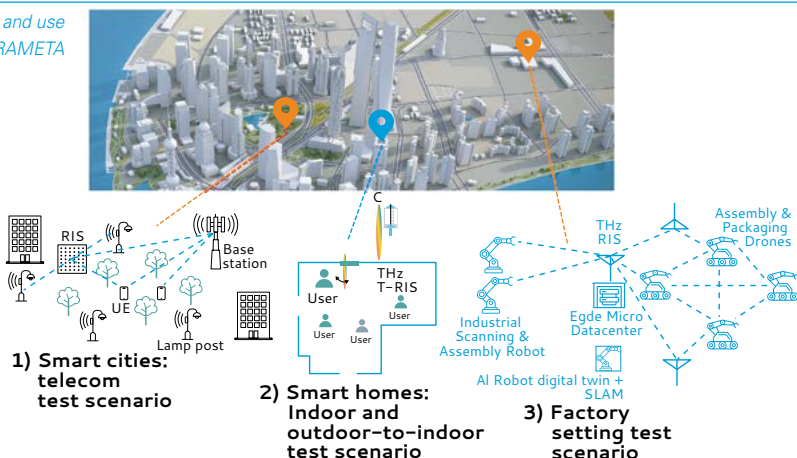

USE CASE/ SCENARIOS

TERRAMETA envisages a set of use cases and scenarios, specifically focusing on:

1) Smart cities: outdoor wireless communications benefit from reflective RISs to avoid the LoS blockage between Base Station (BS) and User Equipment (UE).

2) Smart homes: outdoor-to-in-door mobile communications through

Transmissive RISs (T-RISs) to serve indoor users from an outdoor BS.

3) Smart factories: wireless communications are enhanced by using RISs to overcome LoS blockages between autonomous assembly and packaging robots/drones and an edge micro data centre, enabling massive digital twinning and Simultaneous Localisation And Mapping (SLAM).

RESULTS

The design of RIS unit cells and the development of the corresponding switching system remain a challenging task.

TERRAMETA is designing and fabricating two types of THz fully passive non-reconfigurable RISs: a conventional reflective RIS (R-RIS) and a T-RIS.

The first experimental assessment of the corresponding T-RIS prototype operating around 300 GHz has already taken place.

Furthermore, a prototype of R-RIS operating at 300 GHz is designed to reflect a normally incident wave to 30° degrees and its obtained radar cross-section values confirm the expected efficiencies of around 65% compared with the ideal specular reflection.

Apart from the RIS hardware designs, beamforming algorithms have been developed tailored to the particularities of THz frequencies, i.e., wideband beamforming and near-field beam focusing. Specifically, an algorithm for serving multiple users with a single leaky-wave antenna via wideband beamforming has been proposed.

In addition, localisation and tracking schemes for metasurface-based transceivers have also been studied focusing on the near-field regime.

Performance of designed T-RIS prototype with 37 dBi gain operating at 300 GHz.

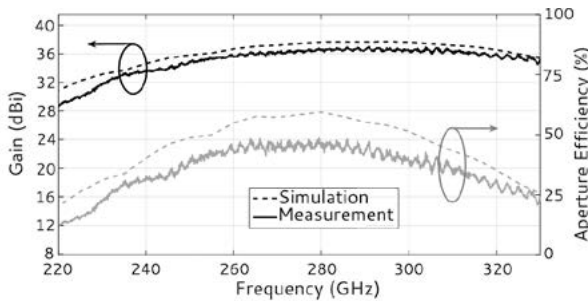

Terahertz Reconfigurable Metasurfaces for Ultra-High-Rate Wireless Communications

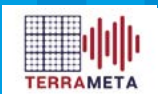

Coordinated by Luis Pessoa (INESC TEC)
January 2023–December 2025

Website: terrameta-project.eu

X: twitter.com/TERRAMETA_6GSNS

LinkedIn: www.linkedin.com/groups/9302818/

Verticals concerned :Smart cities, smart home, smart factory, industry

Project Consortium Members: INESC TEC, National and Kapodistrian University of Athens, University of Oulu, Instituto de telecomunicações, INTRACOM Telecom, CEA Leti, University of Luxembourg, Dell EMC, Technical University of Braunschweig, ACST, Nova University of Lisbon, University of Hertfordshire UH, BT.



R-RIS performance designed to reflect a normal incident wave to 30° degrees (100 x 100 element array operating at 300 GHz)

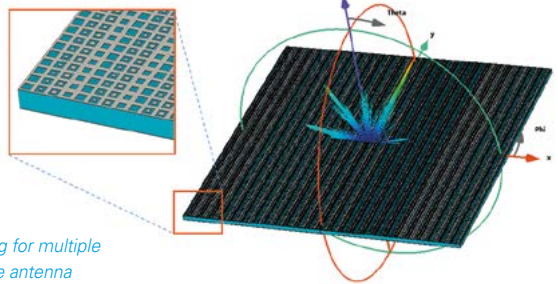

Wideband beamforming for multiple users with a leaky-wave antenna

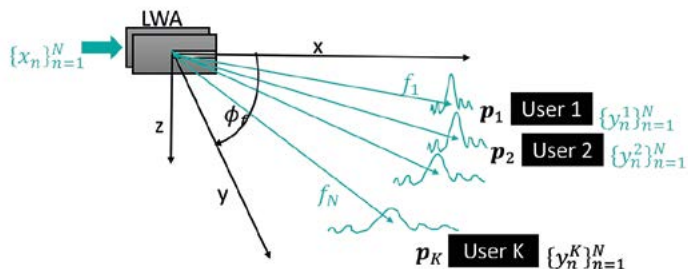

TIMES

The vision of TIMES is a THz-based smart radio ecosystem working in complex scenarios with a large number of heterogeneous devices, capable of offering similar performance as wired networks in terms of data rate (Tbps), ultra-low-latency, sensing, and reliability.

OVERVIEW

Future wireless networks are expected to enable disruptive applications that require performance similar to wired networks in terms of data rate (Tbps), ultra-low latency (less than 1 ms), precise sensing (e.g., mm-level localisation accuracy), and high reliability. However, current 5G methodologies struggle to meet the requirements of such envisioned applications. The TIMES initiative addresses this challenge by bringing together innovative radio channel measurements, reliable communications using THz (terahertz) spectrum bands, intelligent mesh networking protocols, and smart sensing and shaping of the propagation environment. With an emphasis on the industrial context, the project

underscores the importance of high performance, reliability, and sensing capabilities for applications such as cooperative robotics, predictive maintenance, and real-time control.

The project has successfully secured funding under Phase 1 – Stream B of the SNS JU Work Programme, which is dedicated to the development of new technologies for commercial networks in the medium to long term. As an integral part of this initiative, TIMES collaborates with other projects such as TERRAMETA, 6G-SHINE and RESTART-IN. This collaboration includes joint workshops/webinars and joint participation in conferences across Europe, fostering a synergistic approach to technology advancement.

CONCEPT/ARCHITECTURE

TIMES is dedicated to the exploitation of THz communications in industrial environments, with a particular focus on facilitating communication between stationary production machines and mobile robotic systems. The project is committed to pioneering new technological solutions, including innovative THz channel models, intelligent mesh networks, and high-resolution integrated sensing and communication (ISAC) systems.

This effort is structured around three key innovation pillars: ultra-wide bandwidth, intelligent mesh networks, and high-resolution ISAC. By carefully defining use cases and requirements, TIMES aims to validate two proofs-of-concept (PoC) in industrial

environments using real THz wireless links. In particular, the use cases envisioned by TIMES include both moving transmitters and receivers, as well as moving objects that inherently affect channel dynamics.

To achieve its objectives, TIMES will perform precise measurements in industrial environments using a state-of-the-art 300 GHz channel sounder, and subsequently use this data to develop appropriate channel models. Effective communication at THz frequencies requires advanced antenna designs. The TIMES PoC incorporates state-of-the-art THz prototype RF front ends seamlessly integrated with beam steering antennas and Reflective Intelligent Surface (RIS) technologies.

USE CASES/ SCENARIOS

The TIMES project has carefully outlined 15 different use cases for THz communication systems across 6 different application areas. These areas include predictive maintenance, mobile robot management, flexible and modular factory layouts, highly dynamic control systems, augmented reality/virtual reality (AR/VR) and digital twin applications, and seamless fieldbus replacement processes. Each of these use cases has been thoroughly analysed to determine its specific communication and sensing requirements.

In the manufacturing and logistics domain, the project has well-defined use cases tailored for both stationary production machines and mobile robots within short term (up to 3 years), medium term (between 3 and 5 years) and long term (more than 5 years) time horizons. These use cases are grouped into six overarching macro classes:

- Macro class A: Mobile Robot Management.
- Macro class B: Predictive maintenance, monitoring of machines/production lines with high data flow, substitute Field Bus in non-RTI applications.
- Macro class C: AR/VR – Digital Twin – Virtual Commissioning – High-Level Maintenance.
- Macro class D: High Dynamic Control, Substitute Field Bus in RTI for Motion and Robotics.
- Macro class E: Ensuring Seamless and Secure Field Bus Substitution Process.
- Macro class F: Flexible Factory.

FIRST RESULTS

TIMES is dedicated to the development of a THz-based smart radio system designed to operate seamlessly in complex environments with a variety of heterogeneous devices. This system is designed to deliver exceptional performance, including high data rates reaching terabits per second (Tbps), ultra-low latency, advanced sensing capabilities, and unparalleled reliability.

Integral to the system are key components such as THz front ends, beam-steering antennas, and Reflective Intelligent Surface (RIS) technologies. The project has rigorously evaluated designs for these components and is currently engaged in fabricating initial prototypes. In addition, the team has conducted two measurement campaigns to carefully evaluate the performance of the system, with preliminary results documented in two conference papers.

*THz Industrial MESH
Networks in Small
Sensing and Propagation
environments*



*Coordinated by
Luca Sanguinetti, CNIT
(Consorzio Nazionale
Interuniversitario per le
Telecomunicazioni)*

January 2023–December 2025

Website: www.times6g.eu

X: twitter.com/Times_6G

*LinkedIn: [https://www.linkedin.com/
company/times-6g](https://www.linkedin.com/company/times-6g)*

*Project Consortium Members:
CNIT, Aetna Group, Anteral, BI-REX Big data
Innovation & Research Excellence, CNRS,
Fraunhofer, Huawei Germany, Technical
University of Braunschweig, Telenor,
University of Stuttgart*



Stream C

SNS ENABLERS AND PROOF OF CONCEPTS (POCs)

including development
of experimental infrastructure(s)

The three projects in stream C aim to develop EU-wide experimentation platforms that can incorporate promising technical 6G enablers for their further validation. Key aspects for the projects are the reusability and ability to evolve of the experimental platforms over the lifetime of the SNS programme. Accessibility and openness with well-defined and clearly documented technological and business interfaces are also considered key assets of the infrastructures to be developed.

6G-BRICKS

6G-BRICKS offers breakthrough enablers, Explainable AI models and Open interfaces for a truly modular and Open RAN compliant end-to-end 6G experimentation facility.

OVERVIEW AND ARCHITECTURE

The 6G-BRICKS facility will showcase many architecture innovations, such as a disaggregated Management Plane and Operations Support System, to support extensibility, evolvability, and multi-tenancy. The 6G-BRICKS Reference architecture is shown below, including the following architectural tiers:

- The **Experimentation Plane** acts as the entry point to the Facility, delivering intent driven, human-in-the-loop experimentation functionality. A unique testing tool based on Near-RT RIC is scheduled for the first time, giving experimenters

access to low-level RRM and RAN slicing capabilities via standardised xApps.

- The **Management & Orchestration** layer, is deployed at each facility site as a unified controllability framework, via the groundbreaking Domain Management and Orchestration (DMO) framework. Explainable AI mechanisms are leveraged for policy translation and unification. This breakthrough architecture design supports provides explainable feedback to experimenters for potential experimentation issues.

6G-BRICKS overall architecture

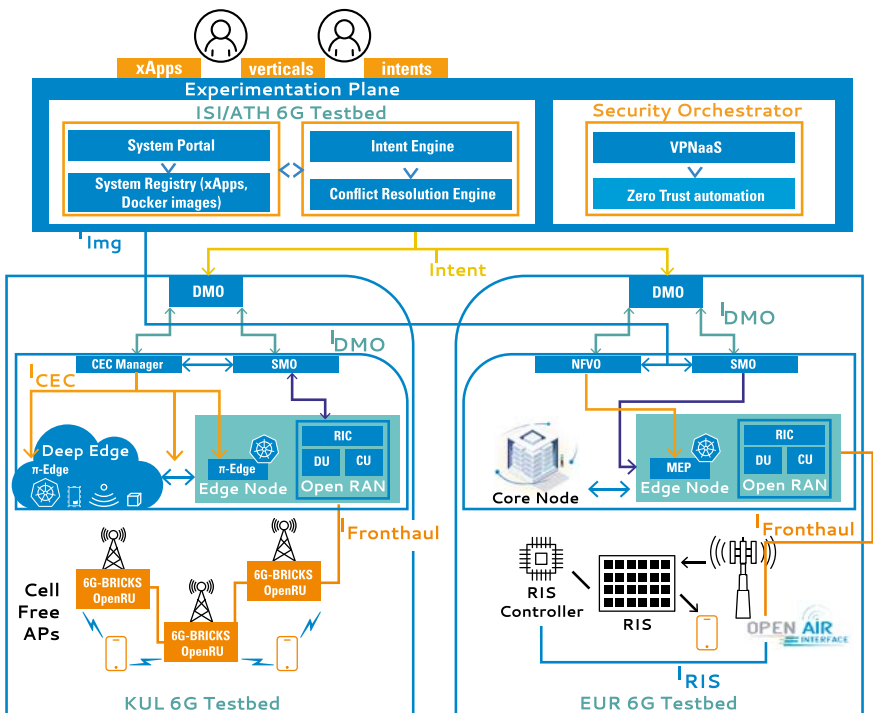

- **6G RAN infrastructure domain** where breakthrough 6G RAN technologies are integrated in reusable, self-contained modules with O-RAN interfaces to ensure the openness and reusability of the developed components. At the KUL site, a Distributed Cell-Free RAN is delivered, while the EUR site builds on the EUR OpenAirInterface O-RAN stack, which will be integrated with a RIS.

USE CASES / SCENARIOS

6G-BRICKS will deliver 2 Use Cases, each with 2 PoC validations:

Use Case 1: Metaverse as an enabler of a Modern Workplace

PoC1 – Holoconferencing in a Virtual Meeting room: A holoconferencing scenario is demonstrated in this PoC leveraging ultrahigh-speed with low-latency communications (uHSLLC) achievable with distributed cell-free technologies.

PoC2 – Virtual Team Building activities: According to this scenario, Virtual Team Building activities demonstrate ultrahigh data density (uHDD) communications and Joint communications and sensing enablers.

Use Case 2: 6G applications for Industry 4.0:

PoC1 – Autonomous robots in Industry 4.0: This scenario focuses on autonomous robot movement in Industry 4.0. To ensure smooth communication, the RIS is leveraged to cover areas where the signal is weak due to scattering and losses (physical obstacles)

PoC2 – AR inspection of Industry 4.0 digital twin on site: This PoC focuses on the visual inspection in the oil and gas industry. For this PoC, the scenario available from Oil & Gas industrial DT is utilised to enhance the availability of critical information considering indoor scenarios.

FIRST RESULTS

Building Reusable testbed Infrastructures for validating Cloud-to-device breakthrough technologies



Coordinated by
Christos Verikoukis (ISIS ATH)

January 2023–December 2025

Website: 6g-bricks.eu/

X: twitter.com/6gBricks

LinkedIn: www.linkedin.com/company/6g-bricks-project/

Project Consortium Members:

ISI.ATH, IQUADRAT, Catholic University of Leuven, CEA, EURECOM, National Instruments Germany, Is-Wireless, Ericsson, INTRACOM, i2cat, BRAINSTORM, Interdigital, EKTACOM, OTE



6G-BRICKS successfully delivered its overall architecture and constituent components design within D2.2, as well as the UC Scenario definition within D2.1. Technical work on the development of the first e2e Open RAN compliant CFmMIMO system is ongoing, with an O-RAN aligned eCPRI-based fronthaul, DU and OpenRU under development on an NI USRP X410 platform. Moreover, the first integration of an O-RAN DU (from the OpenAirInterface project) with a “Luminous RIS” prototype

was completed and reported within D3.1 and D3.2. The aforementioned RAN components will be exposed to experimenters via standardised xApps, which will be made available for the first 6G-BRICKS open call. Finally, breakthrough enablers for the 6G-BRICKS orchestration plane (e.g., the AI driven Cognitive Continuum, and the 6G-BRICKS Domain Manager & Orchestrator) have released their first outcomes, including an abnormal traffic detection PoC that will be reported within D4.1.

6G-SANDBOX

The 6G-SANDBOX project addresses the need for an experimentation facility that guarantees Modularity, Openness, Reusability, Innovation, and Sustainability.

OVERVIEW

6G-SANDBOX develops an automated and modular facility to support in the long term the 6G experimentation ecosystem in Europe. This central scope is further decomposed as follows:

- From the implementation and impact perspective it is reflected a) to the provision of solutions and pathways that guarantee Modularity, Openness, Reusability, Innovation, and Sustainability, i.e., the main characteristics that the facility will be built upon, and b) to the realisation of a cascade funding competitive process (Open Calls) to engage technologies, third parties and stakeholders beyond the project borders.
- From the research perspective it encompasses the request for validating 6G advancements at all the domains of service provisioning chain (end-to-end), and at all planes (user, control, and management).
- From the deployment perspective, it is related to a wide and well distributed deployment of physical infrastructures in EU region, which within the project is fulfilled by four sites (Athens, Berlin, Malaga, and Oulu).

The project belongs to the SNS JU projects portfolio, being funded after the first call of SNS JU Phase 1, under Stream C.

CONCEPT/ARCHITECTURE

Building, exposing, and utilising experimentation platforms for 5G has been addressed in previous approaches/projects, from which two key challenges emerged. The first refers to the need the experimenter to have access to the internal configuration of the network components; for instance, to test new AI/ML algorithms for any optimisation at the network or service level, a fine-tuning of the underlay communication and compute infrastructure is required by the infrastructure owner. The second challenge refers to the lack of capability to run medium- or long-term experiments, or even complete projects, without the involvement of time-consuming manual reconfiguration and provisioning of the setup from time to time. Both challenges are related to the poor capability of the underlay infrastructure to automatically support multi-tenancy in a secure way.

In this context, the 6G-SANDBOX project provides the means for the generation of testbeds in the form of Trial Networks. A Trial Network (TN) is defined as a fully configurable, manageable, and controllable network that combines virtual, physical, and emulated resources (i.e., digital twins) and enables experiments for validating 6G technologies and measuring 6G KPIs. Instances of Trial Networks might be offered targeting specific network domains and technologies. Within the project, end-to-end Trial Networks will be offered by the four experimentation platforms: located in Malaga, Spain; Berlin, Germany; Oulu, Finland; and Athens, Greece. By its definition a Trial Network is an abstraction of an actual testbed and can be reserved and securely configured through multi-tenancy by experimenters.

USE CASES/ SCENARIOS

The project develops an experimentation facility agnostic to the vertical industry that requests technology validations and 6G KPI measurements. However, the project has an internal proof of concept use case that combines XR and haptic communications for immersive and touch experience to remote audience. In addition, to facilitate the interaction with the 6G-SANDBOX facility, a set of roles has been defined for interest any third party, namely: 6G-SANDBOX

Experimenter; 6G-SANDBOX Trial Network User (TNU); 6G-SANDBOX Trial Network Operator (TNO); Third party Technology Provider for the 6G-SANDBOX facility; Third party host for the 6G-SANDBOX framework. In this context, open Call#2 of the project invites third parties to deploy and test a broad scope of applications, e.g., coming from various vertical sectors, tailored for the future 6G communications networks (e.g., use cases described in ITU FG-NET2030).

FIRST RESULTS

The project started on January 1, 2023, and so far, the consortium has managed to:

- Design and release a reference architecture for the facility (presented in D2.1)
- Conduct development activities in four dimensions of the compute and connect infrastructure: a) set up of an O-RAN infrastructure with xApp hosting capabilities, b) expansion of the transport network with LEO/satellite components c) integration of a RIS solution, and d) provision of a programmable UPF, towards deterministic networks.
- Release key components (initial version), namely the 6G-Library where all the software components of a Trial Network are listed, as well as the Trial Network Life Cycle Manager (TNLCM) which is the heart of the overall architecture. D3.1 describes in detail the work conducted.
- Integrate inputs from Open Call#1, where 7 projects were selected, and they currently provide expansions to the 4 experimental platforms of the project. The delta with respect to the beginning of the project for each one of the platforms is included in deliverable D4.1.
- Issue tangible activities took place towards the 6G-SANDBOX openness approach, by becoming part of the ecosystem of ETSI SDG OpenCAPIF.
- Release eight contributions to 3GPP SA2 & SA6 have been provided (S2-2305017-19-21, S2-2305429-74, S6-232418-20 and S6-233073)
- Conduct multiple outreach activities, from which we highlight a) the three MoUs that have been signed with ESA, ITRI, and SLICES-RI, b) the effort to bring in other SNS JU projects by setting up specific Engagement process and taken actions for collaboration, and c) the dissemination effort which already counts 24 presentation, 13 scientific publications.



Coordinated by
Michael Dieudonne
Keysight Technologies

January 2023–December 2025

Website: <https://6g-sandbox.eu/>

X: twitter.com/6GSANDBOX

LinkedIn: [www.linkedin.com/
in/6g-sandbox-project/](https://www.linkedin.com/in/6g-sandbox-project/)

Verticals concerned :

Any vertical industry is welcome to use the 6G-SANDBOX facility. No vertical-specific approach is followed.

Project Consortium Members:

Keysight Technologies Belgium and Denmark, Institute of Software Engineering and Technologies at the University of Malaga, Fogus Innovations & Services, Infolytis, Boreal Technology & Investments, Telefonica, National Centre of Scientific Research "Demokritos", Cosmote, Nokia eXtended Reality Lab, University of Dulu, Ictficial, OpenNebula, Eurescom, IS-Wireless, Fraunhofer (FOKUS), Lenovo, Queen's University of Belfast



6G-XR



6G eXperimental Research's ambition is to strengthen European leadership in 6G technologies by enabling next-generation XR services and infrastructures that will provide beyond-state-of-the-art capabilities in the run-up to the 6G era.

OVERVIEW

6G-XR is developing a multi-site experimental research infrastructure to provide a validation platform for various 6G use cases. This involves the development of networking and computing enablers, radio access technologies beyond 5G, Extended Reality (XR) services with built-in federation, trial management platform, abstraction

tools, as well as frameworks for energy measurement and optimisation.

The 6G-XR consortium comprises 15 partners from eight countries, ideally assorted to effectively contribute to next-generation XR services, also thanks to the strong presence of 6G IA members.

CONCEPT/ ARCHITECTURE/ TECHNOLOGIES

6G-XR is building its reference architecture design and experimental infrastructure network component deployments on top of three envisioned development avenues of 6G. These are the 3GPP evolution path, open source/ Open Radio Access Network (O-RAN) path, and disruptive 6G path, which contains concepts such as sub-THz communications, Integrated Sensing and Communication (ISAC), and Reconfigurable Intelligent Surfaces (RIS). Each 6G development path has a distinctive set of technology enablers contributing to the overall network architecture required to support the use cases targeted by the project.

to better support the dynamic needs of XR applications and automated AI-powered network management. The 6G-XR use cases will develop solutions that are able to interact with the communication infrastructure to provide better quality of service and experience to the end users. Experimentation will be facilitated by exposing network resources and providing a trial engine that enables remote experimenters to configure, deploy, and execute trials at the 6G-XR test facilities. The key architectural domains for 6G-XR innovations and interactions are shown in the figure.

By utilising the interfaces and APIs available in the deployed network components, the architecture is developed

Both the complete reference architecture design and detailed definition of the experimental facilities are to be finalised and published in June 2024.

Key architectural domains for 6G-XR innovations (purple) and interactions (blue)

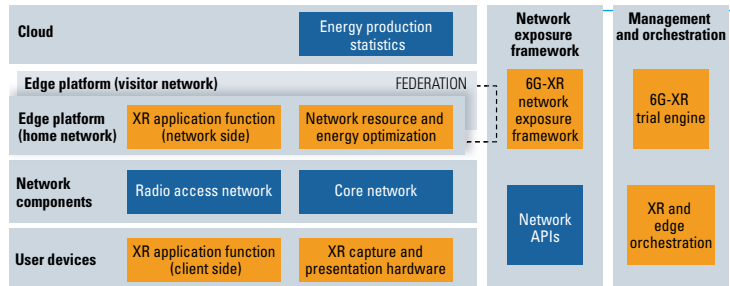

USE CASES/ SCENARIOS

The details of the project use cases have been finalised during 2023 and reported in the 6G-XR deliverable D1.1¹. The use cases focus on three distinctive topics, which are Real-Time Holographic Communications, Collaborative 3D Digital Twin Environments, and Energy Measurement Framework for Energy Sustainability. A total of five use cases under these topics are used to verify and validate the performance, functionality, and energy efficiency of

the deployed experimental facilities realising the 6G-XR reference architecture design. The use cases will test the communication network's capabilities to adapt to the changing needs of the utilised XR applications and vice versa. Studies are conducted by taking into consideration the service quality/experience of the end users, resource orchestration between several networks, and prospects for further development of XR use cases especially when disruptive 6G technologies are used.

¹ Requirements and Use Case Specification

FIRST RESULTS

In addition to the detailed description of the project's five use cases, the 6G-XR deliverable D1.1 lists the functional and non-functional requirements as well as the targeted Key Performance Indicators (KPIs) and Key Value Indicators (KVI) for them. The first results also include a preliminary draft for the 6G-XR reference architecture. The initial design provides a better understanding of the principal architectural components required to support the project use cases and the related key enabling technologies at both network and

application sides. This information will be used as a foundation for the project's subsequent technical tasks working on the development of the different architectural domains depicted in the figure.

During the first project year, 6G-XR also successfully organised its first open call. The eight projects selected for implementation during the spring of 2024 will develop and test new platform and network enablers on top of the 6G-XR experimental facilities in Finland and Spain.

*6G eXperimental
Research to enable next-
generation XR services*

6GXR

*Coordinated by Jussi Haapola
(University of Oulu)*

January 2023–December 2025

Website: www.6g-xr.eu/

Twitter: twitter.com/6GXR_eu

*LinkedIn: [www.linkedin.com/
company/6g-xr/](https://www.linkedin.com/company/6g-xr/)*

*Verticals concerned :
Media and Entertainment/XR*

*Project Consortium Members:
University of Oulu, Instituto de
Telecomunicações, i2Cat, Vicomtech,
VTT, Martel, Matsuko, Raytrix, Caggemini,
Ericsson, Intel, Nokia,
Telefónica, IMEC,
InterDigital Europe.*





Stream D

LARGE SCALE TRIALS AND PILOTS WITH VERTICALS

including the required infrastructure
to explore and demonstrate technologies,
advanced applications and services
in vertical domains

Four projects are implementing large-scale SNS trials and pilots with specific verticals of high economic and societal importance. The aim is to explore and demonstrate 5G/6G technologies, advanced applications and services in vertical sectors such as energy, construction, automotive, manufacturing, eHealth, culture, and media.

Additionally, these large-scale trials aim to serve as catalysts for the creation of viable business ecosystems; Stream D projects incorporate technologies that are currently key enablers for 6G networks, including AI/ML, cybersecurity, cloud/edge and advanced IoT solutions etc.

FIDAL is targeting the augmentation of human capabilities, allowing vertical industry players to perform advanced technological and business validation in large-scale field trials.

OVERVIEW

Industry verticals and enterprises have developed diverse needs for rapid development of advanced services. FIDAL's ambition is to go Beyond 5G, leveraging on the potential of Network Applications (NApps) ecosystem to meet those needs through abstracted sets and new business models. FIDAL's objectives are: i) to extend and deliver an advanced future proof Evolved 5G test infrastructure, ii) develop and extend innovative, next-generation and business-relevant services, and applications in Media and PPDR, iii) implement a unified framework to drive end-to-end network and service management decision via Zero-touch

engine, iv) establish a Repository of NApps AI-driven tools, trainings and data models, v) implement an end-to-end Security Framework, vi) contribute to standardisation activities, dissemination and exploitation of results. FIDAL is one of the 4 projects that are implementing large-scale SNS trials and pilots focusing on verticals with high economic and societal impact. By allowing industry players to perform advanced technological and business validation in large-scale field trials, FIDAL is contributing to cultivating the ground to future 6G technology.

CONCEPT/ARCHITECTURE

FIDAL develops technologies that offer network slice capability exposure, subscriber-aware northbound APIs, location capabilities, efficient data delivery and analytics for applications and support for service continuity by minimising service interruption. The project provides a pool of techniques based on the concept of Auto Machine Learning (AutoML) and efficient online model replacement to get well-adapted models to the specific nature of Media & PPDR verticals. A series of services are generated in the form of AI as a Service (AlaaS) offering capabilities for the generation of self-adaptive

ML models with specific orientation to each vertical. FIDAL aims to offer a trusted, secure, standards-based integrated Facility, supporting multi-tenant, DevOps-driven experimentation. FIDAL has already deployed the necessary artifacts and started its first lab trials. Most of the NApps have also been deployed including Haptic Vest, Remote Scene Analysis and Augmented Reality (AR) Annotation, Cloud-native Physics Service for multi-user Extended Reality (XR) scenes, AFD NApp (for the management of emergency situations).

USE CASES/ SCENARIOS

FIDAL Use Cases (UCs) have been selected with the purpose to assess beyond 5G technology capabilities and to enable their market exploitation while considering societal, business, and economic impact. Seven UCs have been identified. For all UCs, NApps integration and lab testing have initiated with activities intensifying in Year 2.

UC1: Remote sensing in real time by connecting VR content to the Haptic Vest NApp. The UC is working on the API that will be included in the VR content.

UC2: Digital Twins for First Responders (FR) – automatic deployment and monitoring algorithms to keep FRs continuously updated through the AFD NApp.

UC3: City Security Events/Incidents – the aim is to provide a city area

coverage with 5G evolution capabilities for PPDR. The deployment of a complete Mission Critical Multimedia Communication and Collaboration (MCX core) NApp is on the way.

UC4 aims to enhance end-user in-stadium experience by allowing fans to access a wide range of multimedia content while serving as content provider. Currently the UC is in the lab testing phase.

UC5 supports networked music performance: music played live between remote musicians (a live music concert, or remote school rehearsals)

UC6 XR-Assisted Services for Public Safety. XR-application design and original implementation are finalised with successful local tests.

UC7 is currently in work in progress and will expand from UC4 and UC5.

FIRST RESULTS

During its first year, partners have accomplished the necessary steps to establish the groundwork for the implementation of the project. By leveraging on the work of previous 5GPPP and SNS projects, FIDAL has defined the framework and architecture that will allow the successful deployment of 5G labs and facilities. Throughout this process, Key Performance Indicators and Key Value Indicators (KVI) continue to be defined and developed to ensure that these performance metrics can support the maximisation of the societal and economic impact of the project's results. FIDAL has also advanced in

the development of repositories that will facilitate the collection of lessons learned, resources and documentation facilitating information-sharing and collaboration. Lastly, in Q3 and Q4, the project has successfully concluded its first Open Call with over 90 applications received, of which more than 20 will be funded. Trials are expected to start in the first half of 2024. The exploitation of beyond 5G/6G networks are expected to boast ultra-high speeds, and capacity and ultra-low latency, building a more collaborative and inclusive ecosystem than previous generations of networks.



Coordinated by
Ioannis Markopoulos (NOVA)
January 2023 – December 2025

Website: fidal-he.eu

X: twitter.com/project_FIDAL/

LinkedIn: <https://www.linkedin.com/in/fidal-project-b21227262/>

Verticals concerned:
Media and Public Safety

Project Consortium Members:
NOVA, eBOS, Athena Research, PIU,
iQUADRAT, FORTH, Telenor, Ektacom,
Airbus, PSCEurope, p-NET, University
of Patras, UBITECH, Telefonica I&D,
University of Malaga,
Apart, Satways,
OWO, Drama.



IMAGINE-B5G

Imagine-B5G is working to provide an advanced and accessible end-to-end (E2E) 5G platform for large-scale trials and pilots in Europe.

OVERVIEW

The Imagine-B5G facility will fuel testing and experimentation of core technologies and architectures, facilitating innovative services and businesses, and become a key enabler for future B5G vertical services and applications.

Imagine-B5G is leveraging four advanced 5G experimental facilities,

located in Norway, Spain, Portugal and France. These facilities are already and will continue to, during the project's lifetime and through Open Calls (OC), on-board third parties (e.g., SMEs, industry, and researchers) to collaborate in vertical experiments (VE) and platform extensions (PE) through pilots and trials.

USE CASES/ SCENARIOS

The project is already working on 7 verticals and corresponding stakeholders related to PPDR, media and entertainment, education, agriculture, health, transportation & logistics, and Industry, which are experiencing and testing their use cases on Imagine-B5G platform. In its Open Call, two different types of projects – vertical experiments (VE) or platform extensions (PE) had the possibility of applying to the four different facilities as detailed below.

- **5G-NEPTUNE: 5G-and-beyond Network Extensions towards Public neTwork integrated non-pUblIC NeTwork**, a PE, by Athonet. It consists of a platform extension that will equip Norwegian facility with Non-public 5G Core network instance for PNI-NPN experimentation and upgrade their 5GC in Network on Wheels with IP multimedia Subsystem (IMS).

Spain Facility

- **ADAPT-5G: Advanced Drone-Assisted Port Technology with Augmented Reality and 5G Communications**, a VE, by ETRA AIR and XReality Factory, which will showcase a fully functioning drone security system integrated with the B5G terrestrial network, covering large areas efficiently.
- **AGRO4+5G: Agro-4.0 based on 5G**, a VE, by QAMPO, which will interconnect agricultural sensors with data infrastructure using B5G and Network as Code technologies, enabling a simpler and faster way to interconnect agriculture solutions.
- **DEMOCRATS: eDgE platforM fOR dynamiC xR applicATIOnS**, a VE, by TKI, which will focus on a gaming XR application leveraging B5G features and tracking real objects in real time.

Norway Facility

- **ALMA (Ai gLoves huMan Activity)**: 5G-enabled AI gloves as IoT sensor of human activity, a VE, by Mimetik UG, which aims to improve the blue-collar training in industry 4.0 environment by using the 5G integrated AI enabled gloves.
- **LEOSED: Leveraging Edge Optical Sensing for Emergency Diagnostics**, a VE, by Huawei Germany, which aims to experiment Future B5G/6G eHealth application by employing optical wireless sensing for rapid diagnostics of patient markers.
- **AI4FS: Artificial Intelligence for Forest Surveillance**, a VE, by iLink Nees Technologies OE, which aims to provide advanced forest monitoring and surveillance methodology by deploying UAV's and ground sensors.

Advanced 5G Open Platform for Large Scale Trials and Pilots across Europe



Coordinated by David Gomez-Barquero (Universitat Politècnica de València)

January 2023–December 2025

Website: <https://imagineb5g.eu/>

X: twitter.com/B5GImagine

LinkedIn: <https://www.linkedin.com/showcase/imagine-b5g>

Verticals concerned : Agriculture and forestry, education, eHealth, industry 4.0, Media and Entertainment, PPDR, Transport and Logistics

Project Consortium Members: Universitat Politècnica de València, Telenor, Telefonica, Altice Labs, Nokia Spain and Finland, Cag Gemini, Samsung, Keysight, Ubiwhere, Airbus, Port of Valencia, Eurecom, Telecommunications Institute, Oslo University, South East Technological University, Athens University of Economics and Business.



- **BEST5G: Bidirectional Education System based on holographic cabins Through 5G Networks**, a PE, by Aumenta Solutions, which will provide State of the Art (SOTA) holographic displays to the Spanish facility and perform real-world trials and KPI/KVI studies.

Portugal Facility

- **Drone Care Angel (DCA): Mobile health monitoring as a service enabled by beyond 5G**, a VE, by Load Interactive and Instituto Pedro Nunes, which consists of a proactive care service using drones, IoMT, AI, AR, 5G, and MEC to monitor health conditions and safety, enhancing remote user monitoring.
- **SAFER-FLOW: Situational Awareness Framework Enabling Robust Emergency Response for Urban Flood Warnings**, a VE, by OneSource which aims to develop a system that allows rapid response in cases of floods.
- **ULTRA-FAB5G: Ultra Low Latency M2M communications for 5G enabled Fabrication System**, a VE, by RIA STONE which aims to validate Industry 4.0 transition, comparing 5G URLLC with legacy wired networks while removing hardware from the shop floor.
- **SRS-B5G: Imagine B-5G srs-RAN Platform Extension**, a PE, by Software Radio Systems Limited which aims at extending IMAGINE-B5G Portugal facility with a complete

multicell Open RAN deployment, including 5G RAN positioning features.

France Facility

- **ProSe-Serv: Enabling Proximity Services- A Server-based practical deployment**, a VE, by HOPCAST that will deploy and test 3GPP-compliant Proximity Services (ProSe) on top of the EURECOM facility, based on open technologies such as OpenAirInterface (OAI). Consequently, ProSe can be used at an early stage and advantageously deployed, tested and transitioned to native 5G ProSe when they will become available.
- **F-EXTENSION: Extension of the IMAGINE-B5G French platform**, a PE, by Allbesmart and CMSF- Sistemas de Informação which aims to implement three extensions: (i) a configuration platform for the OpenAirInterface (OAI) 5G Core Network; (ii) mmWave Joint Communication and Sensing using Computer Vision; (iii) 3GPP-compliant Short Data Transmission (SDT).
- **CAMARA API: Extending IMAGINE-B5G framework & facilities**, a PE, by Fingletek, which will implement the CAMARA APIs on top of OpenAirInterface (OAI) platform providing seamless access to diverse telecommunications network capabilities offered by the IMAGINE-B5G facilities.

FIRST RESULTS

The Imagine-B5G project expects to have a huge impact worldwide among vertical industries by:

- Equipping European verticals with facilities that will increase their ability for innovation, digitalisation and driving European economies.
- Deploying concurrent trials which will serve to prove that operators are able to deliver on the stringent technical requirements of new 5G/6G applications.

- Using its pilots with vertical and cross-vertical industries to demonstrate Europe's B5G evolution and leadership in advanced 5G technologies and architectures.
- Preparing and maximising widespread acceptance and adoption by end-users of B5G solutions in European economies.

During the first year of the project, Imagine-B5G successfully launched its first Open Call which attracted 68 submissions and was able to fund 15 projects.

TARGET-X

The TARGET-X project is accelerating the digital transformation of four key verticals: energy, construction, automotive, and manufacturing.

OVERVIEW

The TARGET-X project accelerates the digital transformation of four key verticals: energy, construction, automotive, and manufacturing large scale trials and pilots in testbeds throughout Europe will demonstrate, validate, and evaluate the potential of 5G/6G in real environments. The testbeds for the four verticals in TARGET-X are spread across two locations, with four testbeds being part of the 5G-Industry Campus Europe (5G-ICE). The fifth testbed is located on the automotive testing grounds of IDIADA in Spain. The facilities will enable testing and evaluating the most advanced 5G/6G

technologies, such as real-time communication, localisation, self-description, digital twinning, and sensor-network data fusion. To assess the effectiveness of the developed technologies, the project's evaluation will focus on Key Performance Indicators (KPIs) and Key Value Indicators (KVIIs), such as sustainability, safety, security, and privacy. This paves the way for new business models and a methodological assessment framework for economic and social evaluation. The development of these solutions will be supported and guided by the TARGET-X consortium.

USE CASES/ SCENARIOS

TARGET-X explores use cases from four different verticals on two geographical sites, offering unique testing possibilities with a broad spectrum of available technologies and infrastructure, 5G network architectures, and layouts.

The existing Infrastructure holds an indoor NSA-based 5G network, can be utilised for development, testing, and validation experiments. The laboratory represents a simulated environment of modern industrial shopfloors.

Energy: Focusing on measurement for energy awareness, carbon and lifecycle emission assessment, data-driven energy decision-making enablers, optimisation and monetisation possibilities in a cross-vertical approach. The energy monitoring testbed's realisation uses a multi-site set-up, reflecting the cross-vertical approach.

Cloud native production: Extensive measurement and diagnostic equipment is at hand to carry out performance and diagnostic measurements in the 5G and the production network at the 5G-ICE, including a set of machine tools for manufacturing, milling machines, combined milling and turning centres, production metrology machines and optical sensors, injection molding, embossing machines, and laser material processing machines. On-premises Kubernetes Cluster, a VMware vCentre Server, and a TSN testbed, for real-time communication and computation for cloud-in-the-loop applications.

Robotics: The line-less mobile assembly laboratory consists of multiple robots, real industrial product cases, large-scale metrology systems, and a 5G indoor network. The robot fleet is heterogeneous and can be controlled by open-source control architecture based on ROS.



*Trial Platform for
5G Evolution – Cross
-Industry On Large
Scale Identity card*

Coordinated by Niels König,
Fraunhofer Institute for
Production Technology IPT
January 2023–June 2025
Website: <https://target-x.eu>

LinkedIn: www.linkedin.com/showcase/target-x/

Verticals concerned:
Automotive, Construction, Energy and
Manufacturing

Project Consortium Members:
Fraunhofer for Production Technology
IPT, Ericsson Germany and Turkey, RWTH
Aachen University, IDIADA Automotive
Technology, Center Construction Robotics,
I2CAT foundation, Marposs, FundingBox
Accelerator, 5G Communications for Future
Industry Verticals,
Marposs Monitoring
Solutions, Neutron,
Mitsubishi Electric,
FundingBox Communities,
Qualcomm.



Construction: Innovative construction processes, products, and concepts can be tested and evaluated under real-life conditions, including networked construction machines, the implementation of robots into construction processes, software solutions, but also the proof of new working, communication, and teaching concepts. A unique approach of mounting a 5G radio node on the highest vantage point of the construction site, a tower crane, was chosen.

Automotive: The proving ground spans an area of 350 hectares, gathering 15 multi-purpose test tracks with a unique controlled environment capable of reproducing worldwide network

configurations and conditions to develop and validate connected vehicle solutions. The testing ground has an operational network, supporting mobile communication generations from 2G to 5G NSA, with bandwidths as they can be found in public networks.

In TARGET-X, four different verticals are contributing to individual use cases. The project intends to ensure the evolution of the testbeds by gradually introducing new technology elements from the technology clusters. The effects on the use cases will be evaluated with the help of a Key Performance Indicator (KPI) and Key Value Indicator (KVI) framework.

Testbeds and visions

TECHNOLOGY ELEMENT	VISION
Service differentiation and network convergence	Service types in B5G networks are expected to be more diverse as in today's 5G networks, while at the same time, single networks are converging into larger and more complex networks.
mmWave spectrum	The need for bandwidth increases continuously and learnings can be drawn for future allocated spectrum by analysing the currently available spectrum.
Asset Administration Shell (AAS) and network orchestration	With the growing complexity of networks and increasing numbers of devices, a model is needed to describe networks and UE and how they interact with each other.
Positioning with 5G NR	Positioning information for devices in the network is a key enabler for 5G use cases, such as autonomous vehicles.
Real-time ecosystem	Aspects such as bounded latency, reliable communication, and precise time synchronisation are key in establishing a real-time ecosystem for industrial automation.

EXPECTED RESULTS

- The anticipated outcomes encompass a range of objectives, including:
- The investigation of 5G/6G and peripheral technologies across the whole value chain (devices, connectivity, service delivery) to identify, assess and propose new 5G/6G features targeting connected industries.
 - Enabling future use cases by self-adapting communication networks
 - Dynamic allocation of communication and computation resources across IT&OT
 - KPI and Key (Societal) Value Indicator (KVI) generation from real business cases
 - Enhance the 5G/6G ecosystem in the manufacturing & robotics, automotive, energy, and construction verticals

TRIALSNET

TrialsNet is deploying B5G large-scale trials over wide coverage areas and with the involvement of extended sets of real users targeting a holistic evaluation of the KPIs and KVLs of 6G applications in different domains, encompassing various network deployments and solutions.

OVERVIEW

TrialsNet targets a set of technical, performance and productivity objectives which impact the current 5G ecosystem substantially, effectively leading the B5G technology wave by drawing compelling requirements towards the next generation of mobile networks. The main objectives of the project are: a) Trialling of 6G Applications, b) Enhance B5G

networks to support 6G applications, c) Introduce societal benefits in different areas, thanks to 6G Apps, d) Large scale deployment of B5G Networks, e) Achieve Industrial Impact, f) Achieve Scientific and Standardisation Impact, and g) Create an ecosystem of verticals and technology providers in the trial sites and beyond.

TECHNOLOGIES/ INNOVATIONS

TrialsNet has defined two distinct sets of technologies in the context of its platform and network solutions: the TrialsNet Baseline 5G Technology (Bs5G) and the TrialsNet Advanced 5G Technology (A5G). The Bs5G represents the initial capabilities available at the project's start, serving as a reference point for measuring the preliminary Key Performance Indicators (KPIs) during UCs development. The A5G, on the other hand, represents the enhanced capabilities that will be available across the clusters by the project's end. The improvement work for A5G involves enhancing existing technology within each cluster and incorporating evaluation results from initial UCs implementations. By monitoring and analysing these results, TrialsNet identifies areas for improvement and optimises the technology to

achieve more advanced capabilities and better performances. This approach enables continuous refinement and optimisation, leading to more advanced and capable 5G technology within the TrialsNet's platform and network solutions. On top of this, TrialsNet identified also different innovations that will be experimented in the context of the use cases implementation. More in detail, such innovations have been categorised in a) horizontal, covering transversal aspects of B5G systems such as zero-touch management, B5G application framework, and Digital Twins for next generation mobile networks, and b) vertical, related to specific UCs such as Artificial Intelligence (AI) mechanisms for diagnostic and resources efficiency, and automatic orchestration of slice resources to ensure the QoS in mobility).

USE CASES/ SCENARIOS

TrialsNet is implementing 13 innovative core use cases covering three relevant domains of the urban ecosystems in Europe identified as a) Infrastructure, Transportation, Security and Safety, b) eHealth and Emergency; and c) Culture, Tourism, and Entertainment. The use cases are trialed over wide coverage areas with the involvement of extended sets of real users in 4 geographical clusters (Italy, Spain, Greece, and Romania) on the platform and network solutions including advanced functionalities such as the dynamic management of the network slices, End-to-End (E2E) orchestration, Network Function Virtualisation (NFV), Mobile Edge Computing (MEC) and AI and Machine Learning (AI/ML) methodologies. In this context, sustainability and affordability aspects are also considered

in both design and operational phases of the TrialsNet's solutions.

To evaluate the results of its trial activities, TrialsNet develops an assessment framework to measure the impact of use cases on a technical, socio-economic, and environmental level through the definition and measurement of proper KPIs and Key Value Indicators (KVI) targeting the identification of network limitations, optimisation of infrastructures, and definition of the new requirements for next-generation mobile networks. Finally, TrialsNet has launched a successful Open Call through which it has onboarded more than 20 new use cases and related key stakeholders adding value to the project's activities, extending its infrastructures, and maximising its impact.

FIRST RESULTS

To date, TrialsNet activities have focused on the design and development of the applications related to the use cases. Initial platform and network solutions have been also designed, integrated, and have started to be deployed in each of the project's clusters. In addition, all the use cases have undergone an extensive lab-testing phase to verify the technologies, methodologies, and related procedures, as well as to measure the preliminary KPIs at both application and network levels, in a controlled environment. For some use cases, real beta-users have also been involved to collect questionnaires and retrieve preliminary feedbacks related to the KV. During the second half, an

extensive trials campaign (that will also include the use cases onboarded by the project through the Open Call) will be performed in which a relevant amount of data in terms of network performances and feedbacks from the users will be collected. Such data will be analysed and evaluated to identify, on one side, the potential limitations of the current network technologies and, on the other side, to understand the level of acceptance of the proposed applications from the user's perspective. The results of such analysis will be used to consolidate the outcomes and findings of the project which will be used as input to contribute towards the definition of the 6G ecosystem.



*Trials
Supported
By Smart
Networks
Beyond 5G*

Coordinated by
Silvia Provedi (Ericsson)

January 2023–December 2025

Website: www.trialsnet.eu

X: twitter.com/trialsnet

LinkedIn account: www.linkedin.com/company/trialsnet/

Verticals concerned:
Infrastructures, Transport, Security and Safety, eHealth and Emergency, Culture, Tourism and Entertainment

Project Consortium Members:
Ericsson Italy and Spain, Telecom Italia, Orange Romania, Nextworks, WINGS-ICT, University Carlos III of Madrid, IMEC, YBVR, CNIT, Telefonica I&D, Italian Institute of Technology Foundation, Athens International Airport, Sant'Anna School of Advanced Studies, PIU, City of Turin, Gheorghe Asachi Technical University of Iasi, Prosegur security, Crossmedia, DAEM, the Italian Institute of Clinical Physiology, the Hellenic Institute of Transport, Realwireless



COORDINATION SUPPORT ACTIONS (CSAs)

The project portfolio includes two Coordination and Support Actions focussed on internal operational aspects of the SNS Partnership as well as on establishing dialogues with EU initiatives (e.g., related partnerships, national initiatives, etc.) and promote SNS results and achievements at a global level while working towards the formation of global standards.

SNS ICE

The SNS ICE project will provide the collaboration environment for dialogue amongst European and global stakeholders involved in the preparation of 6G smart networks and services.

OVERVIEW

The SNS-ICE project (Smart Networks and Services International and European Cooperation Ecosystem) is the de facto ambassador of the Smart Networks and Services Joint Undertaking (SNS JU), promoting the European Vision for 6G networks to the world. Leading the bidirectional flow of information among European and global stakeholders involved in the

preparation of 6G smart networks and services by means of i) understanding the trends and reporting the B5G/6G Research and Innovation (R&I) activities of the SNS community and ii) disseminating and promoting the R&I work of SNS projects to the rest of the world. Thus providing a collaborative platform for dialogue and global exchange.

PROJECT ACTIVITIES / HIGHLIGHTS

The SNS ICE project has engaged in several activities aiming to analyse the EU and global 6G landscapes and offer useful insights to the SNS community, strengthen the collaboration with relevant EU and international initiatives and associations and promote the work of the SNS JU projects to the outside world. Some of the most important activities of SNS ICE for 2023 are summarised below.

Global 6G Landscape Analysis & International Collaboration

A thorough analysis of the global 6G Research and Innovation (R&I) landscape has taken place, reporting on the global trends per region regarding prioritised 6G enabling technologies, envisioned Use Cases and targeted KPIs. Moreover, the relevant standardisation roadmaps and spectrum developments have also been analysed.

To foster and strengthen European and global collaboration, the project partners have signed more than 26 Memoranda of Understanding (MoUs) and Letters of Interest/Intent (LoI) with organisations and associations of strategic importance, such as the Next G Alliance (USA), 5GForum (South Korea), the Beyond 5G Promotion Consortium (Japan), TSDSI (India), the NGMN Alliance, ESA, 5G-ACIA, AENEAS and more.

EU Research Environment & National Initiatives

Several 6G R&I funding programmes are ongoing, both on the national and pan-European level, offering significant collaboration opportunities. SNS ICE partners performed a comparative

Seven largest European 6G Initiatives interviewed

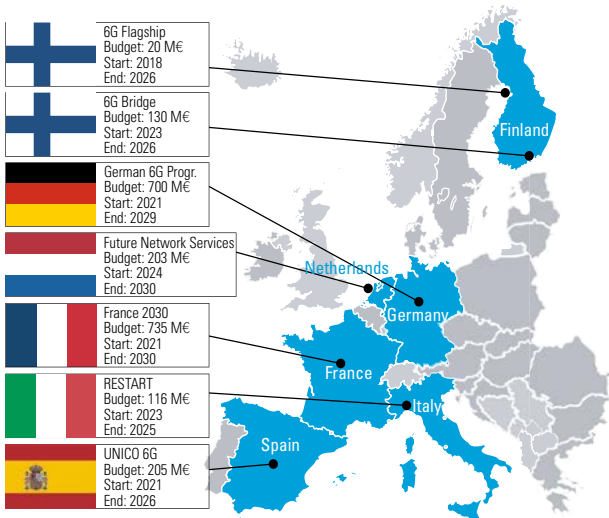



Coordinated by
Kostas Trichias (6G-IA)

January 2023–March 2025

Website: smart-networks.europa.eu/csa-s/#SNS-ICE

X: twitter.com/sns_ice

Verticals concerned : All

Project Consortium Members:

6G-IA, Cttc TNO,
Trust-IT,
Commpla, TIM,
NSN, Eurescom,
Vases.



study of seven of the largest European National Initiatives (first figure) based on interviews with respective national representatives. As a result, 14 key 6G research topics were identified and ranked according to importance/priority, while other vital information like budget allocation, duration, scope, etc., were also identified per National Initiative. This analysis paves the path for active collaboration among National Initiatives and the SNS JU programme.

Vertical Engagement & Trends Analysis

SNS ICE actively engages with stakeholders from vertical sectors, associations, standardisation and regulatory bodies, aiming to understand the trends and the uptake of technology developed for the benefit of society. SNS ICE partners have performed a trend analysis of 9 critical vertical

sectors, taking into account their respective roadmaps and attempting to identify their communication needs by 2030.

Furthermore, the **Vertical Engagement Tracker**¹ tool was developed to systematically map and monitor SNS JU use cases and their relation to relevant vertical sectors. The tool maps both SNS JU R&I projects' use cases and relevant associations, providing a blueprint for vertical engagement. The tool also enables use cases and vertical sector gap analyses across the SNS JU ecosystem, assisting the understanding of requirements and orienting future policy actions. So far, the tool contains over 50 use cases from SNS JU Phase 1 projects and information about nine vertical associations.

¹ <https://verticals-tracker.sns-ju.eu/>

FIRST RESULTS/ IMPACTS

The SNS ICE partners engaged in extensive Community outreach activities throughout 2023 to raise awareness about SNS JU activities and promote the results of the Phase 1 projects, thus maximising the programme's impact. Both European and international audiences were targeted from varied backgrounds through several actions, namely:

- **Workshops/Webinars:** 11 focused workshops and/or webinars were organised by SNS ICE partners with a total reach of more than 1000 people.

- **Event organisation/participation:** 24 physical events in 13 different countries/locations worldwide were organised or contained significant contributions from SNS ICE partners in conferences, symposia, workshops, etc.
- **Podcasts:** 8 podcasts have been published in the SNS ICE channels², providing useful technical insights and discussions with key EU and global 6G experts.
- **Videos:** 11 videos have been produced and published on the project channels, providing overview information about the project, summarising key takeaways from SNS ICE events, and interviewing experts.
- **Other D&C material:** A multitude of additional dissemination and communication material such as newsletters, brochures, flyers, and social media posts were produced within 2023 to support events and spread critical information about SNS ICE and SNS JU activities.

SNS ICE key
outcomes

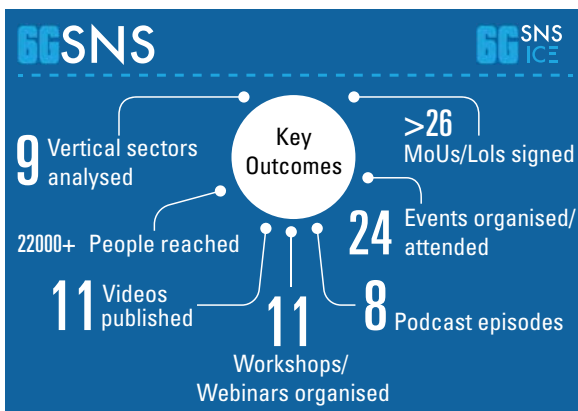

² <https://open.spotify.com/show/0iURPcKEUeT1N0sWgWkN?si=15866be7f35c24178>

SNS OPS

The SNS OPS project is devoted to supporting the operations of the 6G Smart Networks and Services Joint Undertaking (SNS JU).

VISION/ KEY OBJECTIVES

The SNS OPS project is devoted to supporting the operations of the SNS JU. The planned work includes:

- Support for the Smart Networks Services (SNS) European partnership and the related programmatic organisation.
- Organisation of the SNS as a coherent programme with clear links

to the 6G Infrastructure Association and the EC/the SNS JU Office.

- Maximise output and exploitation of SNS project results in key domains, e.g., standardisation and spectrum, through managed cooperation between projects.
- Inter JU coordination and joint actions.

APPROACH

SNS OPS is designed around operating the SNS JU infrastructure and facilities while maintaining and migrating many European ICT research leadership activities from the 5G PPP to the 6G SNS JU. This will bring the European momentum and leadership developed in 5G PPP into the new challenges of the SNS JU under Horizon Europe.

The project team consists of several of the key active players who are instrumental in stimulating the SNS JU initiative and who are in leadership

roles in many of the tasks and support activities in SNS.

Building on this mix of commitment and involvement, SNS OPS can guarantee the competence and capabilities of the project team to support the programme activities and help deliver the large-scale impact. The project is divided into 5 core streams of work that maintain a continuous dialogue with each other, and with the peer CSA for SNS External Cooperation and Global 6G Events – SNS ICE.

FIRST RESULTS

SNS OPS has worked since its start on all 5 core streams of activities and achieved all planned results, even going beyond target KPIs.

In the stream on SNS assessment and planning, a “monitoring and analysis framework” of the technological KPIs, societal KVI, and other relevant work aspects targeted at the SNS projects has been developed. A questionnaire used to collect information from the SNS Phase 1 projects, structured into questions on Technical, Vision and Market aspects has been developed and answered by the Phase 1 projects. The thorough analysis of the project responses yielded valuable insights

that were published and presented in a webinar and further used e.g. in the SNS Work Programme generation process which SNS OPS partners have supported and made various contributions to. The project responses show e.g. that all specific objectives of the SNS Work Programme are well matched by the Phase 1 projects. Moreover, a healthy balance and complementarity has been detected among the projects. The analysis also showed that the focus of the projects in addressing societal challenges is on technology challenges. This aligns well with the scope of the SNS Work Programme. Also a few interesting

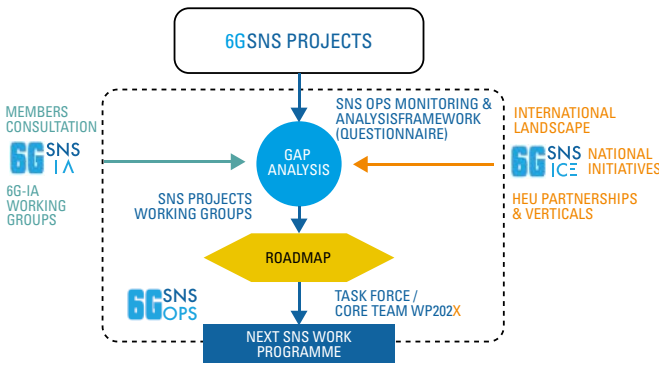

SNS OPS Gap Analysis & Road-mapping process

insights on the market outlook and trends were gained.

In the second stream SNS Outreach: Dissemination and Communication, SNS OPS has deployed online and offline communication measures to reinforce the SNS brand. Various activities have been employed to strengthen collaboration and orchestrate communication and marketing of all the SNS stakeholders. Key activities include online marketing activities and the production of online and printed promotional materials. The SNS JU website which SNS OPS maintains serves as a central information hub and has experienced a strong interest and engagement from the community. In terms of social media outreach on platforms like LinkedIn and X, the SNS outreach grew significantly in 2023, with the LinkedIn followers increasing from 679 to 2,483 and Twitter followers reaching 9,173. This extended reach demonstrates the SNS JU’s ability to engage a wider audience. Further activities include the support of communications at events – e.g. EuCNC’23 or MWC’24 – and press coverage and promotional activities.

In the third stream SNS OPS organises and supports the SNS programme organisation and orchestration. This work takes care of supporting the main SNS initiative bodies, Steering and Technology Boards, ensuring efficient collaboration among the SNS projects. In addition, SNS OPS has managed the establishment of an SNS Collaboration Agreement among SNS JU projects to facilitate their collaboration within the programme

and support implementation of the collaboration processes.

The fourth stream is dedicated to Stakeholder Engagement and WG Support, aiming on global stakeholder involvement and interactions. To optimise the value and impact of the SNS JU programme, the strategy contains tailored activities for core groups of stakeholders, including verticals and complementary domains, SMEs, WGs, and peer Partnerships, Initiatives and Associations. Several Events have been organised – e.g. for Digital Innovation Hubs, on Microelectronics and on Security – which goal is to understand the relevance and impact of the SNS JU in the specific–SNS domains and to gather feedback on the expectations.

The fifth stream – Events logistics and IT infrastructure – has taken care of the provision of the SNS JU working IT infrastructure and of all aspects on the preparation and orchestration for SNS “owned” events. The goal was to ensure that every event organised is prepared in a professional way maximising the value for participants. Examples include the EuCNC & 6G Summit 2023 and an SNS Session at MWC 2024. Overall, SNS OPS has provided support at various levels to 19 events in its first year. In terms of “IT infrastructure”, SNS OPS has taken care of the organisation, production and provision of the SNS JU working IT infrastructure, from mail servers and repositories over the brokerage service to the SNS JU website¹. The SNS JU website attracted 62,024 visitors with 105,707 unique page views until the end of 2023, indicating a strong interest and engagement from the community. The SNS JU BSCW repository is operational since September 2023 and has 5,712 documents stored in 1,363 folders with a total size of 36 Gigabytes. The SNS JU mail list server has distributed 1.3 million emails with a traffic size of more than 268 GB (as of January 2024).

SNS OPS will continue its activities on all streams in 2024.

¹ <https://smart-networks.europa.eu>

- WP1 Assessment and Planning
- WP2 SNS Outreach: Dissemination and Communications
- WP3 Programme Organisation and Orchestration
- WP4 Stakeholder Engagement and Group Support
- WP5 Events and Logistics

SNS OPS Work Packages

Supporting the SNS JU Operations



Coordinated by Uwe Herzog (Eurescom) January 2023–March 2025

Website: <https://smart-networks.europa.eu/csa-s/#SNS-OPS>

Project Consortium Members: Eurescom, 6G-IA, Nokia Solutions and Networks, Thalès France, Telenor, Orange, IDATE, Nokia networks, SETU, Australo, Trust-IT/CommPla, Instituto de Telecomunicações, Martel, University of Surrey.



Call#2 Projects

The 28 SNS call#2 projects started in January 2024 and March 2024 in three streams and sub-streams and one CSA.

Stream B

WIRELESS COMMUNICATION TECHNOLOGIES AND SIGNAL PROCESSING

The stream B covers research for revolutionary technology advancements, in preparation for 6G and revolutionary advancements for IoT, devices and software.

The stream targets low to medium TRL in WP2023, with the objective of delivering innovative solutions towards real life networks, in a long-term time-period. It also includes targeted international cooperation with the USA centered on Artificial Intelligence.

The stream B is broken down into six sub-sections encompassing i) System Architecture (B1, 5 projects), ii) Wireless Communications Technologies and Signal Processing (B2, 6 projects), iii) Communication Infrastructure Technologies and Devices (B3, 4 projects), iv) Reliable Services and Smart Security (B4, 4 projects), v) Microelectronics-based solutions for 6G networks (B5, 3 projects), and vi) the EU-USA 6G R&I Cooperation (B6, 1 project).

Stream B1

SYSTEM ARCHITECTURE

The selected projects demonstrate complementarity and have been selected in such a way as to strengthen the structure of 6G networks for increased robustness, adaptability, and efficiency to cater for the expected extreme 6G use cases and their requirements.

6G-CLOUD

An initiative aimed at developing an AI-driven and cloud-compatible architecture for 6G networks.

OVERVIEW

6G-Cloud is a SNS JU Phase 2 Project aiming to investigate, create, and test key technologies to achieve an AI-native and cloud-friendly system architecture on top of the cloud continuum. It will integrate cloud resources provided by multiple stakeholders and enable network functions from different 6G network segments to be flexibly and dynamically composed in hybrid cloud environments.

6G-Cloud addresses the following key topics:

- developing a comprehensive, AI-native service-oriented 6G system architecture on top of a cloud continuum;
- creating AI-driven cloud continuum and management frameworks and business interfaces for a multistakeholder environment;
- establishing an AI/ML framework for native-AI support in the 6G system;
- enabling the 6G “network-of-networks (NoN)” concept using service-oriented network design.

CONCEPT/ARCHITECTURE

6G-Cloud will revolutionise system architecture in the 6G era, supporting a highly versatile Cloud Continuum. This involves composing network functions from various 6G segments in different cloud settings, significantly surpassing current 5G designs. The blueprint for 6G-Cloud encompasses a service-oriented system architecture with fundamental network functions

and various control and management frameworks across a multistakeholder cloud spectrum from extreme edge to central clouds. It heavily utilises service-oriented architecture to integrate RAN with the Core Network using the Service-Based Architecture (SBA) approach and can incorporate resources from multiple providers, aligning with the Cloud Continuum

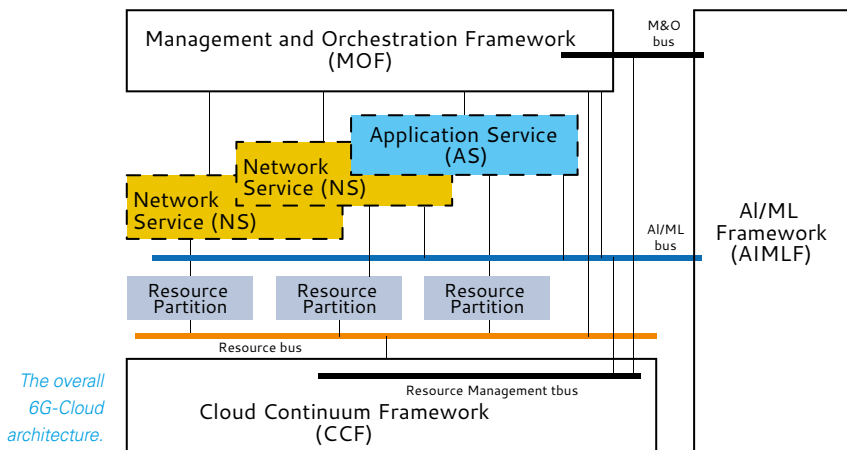

concept. The overall 6G-Cloud architecture (see figure) is composed of the following components:

- Cloud Continuum Framework;
- Management and Orchestration Framework;
- AI/ML Framework;
- 6G Network Service (includes service-oriented RAN, Core, etc., which forms a complete 6G end-to-end network service or sub-network services).

The key innovations in 6G-Cloud include: i) an AI-driven Cloud Continuum Framework and business interfaces for a multistakeholder environment; ii) an AI-driven distributed Management and Orchestration Framework able to cooperate with the Cloud Continuum concept; iii) a 6G native AI/ML Framework capable of monitoring and updating AI-driven functions in real-time; iv) a true E2E service-oriented 6G network design covers end-user terminals through RAN and core to edge applications; v) generic mechanisms for dynamic integration of “virtualised networking solutions” to form a NoN in a multistakeholder environment.

USE CASES/ SCENARIOS

6G-Cloud is developing a cloud-compatible system architecture for 6G, building on use cases from 6G White Papers and EU Hexa-X I/II projects. This system will enhance the limited connectivity of 5G by supporting advanced concepts like NoN and Non-Terrestrial Networks integration. It aims to offer a more flexible, reliable, and resource-efficient solution by

integrating RAN-core network functions into an E2E composable, service-based architecture for demanding 6G applications. The project will analyse 6G use cases within the Cloud Continuum, define KPIs, and focus on reducing its carbon footprint and minimising energy use in the 6G Cloud Continuum.

EXPECTED RESULTS

6G-Cloud offers a diverse framework of advanced technologies for system architectures, emphasising flexible service composition, native AI/ML support, multi-provider resource integration, advanced control programmability, and a Network Digital Twin. Aligned with Europe’s

6G vision for leadership in mobile technologies and accelerating digital transformation, 6G-Cloud focuses on an open, intelligent, cloud-native, sustainable, and secure 6G system, contributing to a more sustainable and efficient society through intelligent communication.

Service-oriented 6G network architecture for distributed, intelligent, and sustainable cloud-native communication systems



Coordinated by Tao Chen,
VTT Technical Research Centre

January 2024 – June 2026

Website: www.6g-cloud.eu

X: @Sns6GCloud

Project Consortium Members:
VTT, Warsaw University of Technology,
National Center for Scientific Research
“Demokritos”, University of Murcia, Orange
Polska, Atos IT Solutions and Services,
BULL, Thales Six GTS France, Lenovo
Germany, BubbleRAN,
Ubiwhere, Four Dot
Infinity PC, University
of Bern.



6G INTENSE

Shaping the Future of 6G with Sustainable, AI-Powered Smart Services and Advanced Network-Compute Integration.

OVERVIEW

6G-INTENSE, a project in SNS B-01-01, offers a new 6G architecture as a **Smart Service Execution platform**. It aligns with sustainable infrastructure sharing, aiming to cut space and energy costs and foster collaboration in the value chain. It focuses on a unified

Network-Compute fabric and intends to develop an AI-native management and orchestration system. This system will feature intent translation and propagation, separate service and resource management, and operate in a diverse environment. It will be built on a Cloud-Edge Continuum infrastructure.

OBJECTIVES

6G-INTENSE introduces a novel automation architecture, named **Distributed Intent-driven Management and Orchestration (DIMO)**, with a Native AI toolkit. This facilitates intent declaration, negotiation, and decision automation across autonomous domains. Sensing is a crucial enabler, addressing the complexities and reliability issues of the Deep Edge. To develop this ambitious system, the project will pursue specific objectives.

1. Offer a **DIMO** for autonomously reconciled intent declarations in multi-stakeholder ecosystems.
2. Deliver an intent-based **Abstraction Framework** for the 6G Network-Compute Fabric.

3. Deliver a **scalable Compute Interconnection** solution based on SD-WAN for self-organised Service Mesh deployments.
4. Deliver the first concrete **AI Native Toolkit** implementation, offering intent decomposition, actuation and reconciliation towards fully Autonomous Domains.
5. Deliver a federated **AI plane for multi-stakeholder 6G ecosystems**, via knowledge optimisation, synthesis and intent propagation mechanisms.
6. Support **privacy-preserving Joint Communication & Sensing** for resilience and dependability at the Deep Edge.

Intent-driven NaTive AI architecture supporting Network-Compute abstraction and Sensing at the Deep Edge



Coordinated by Christos Verikoukis (ISI/ATH)

January 2024 – December 2026

Website: <https://6g-intense.eu>

X: twitter.com/6gIntense

LinkedIn: linkedin.com/company/6g-intense-project

Project Consortium Members: ISI/ATH, EURECOM, L.M. Ericsson, Intracom, Orange Romania, OTE, Consiglio Nazionale delle Ricerche, Iquadrat, University of Oulu, eBOS, Realworld.

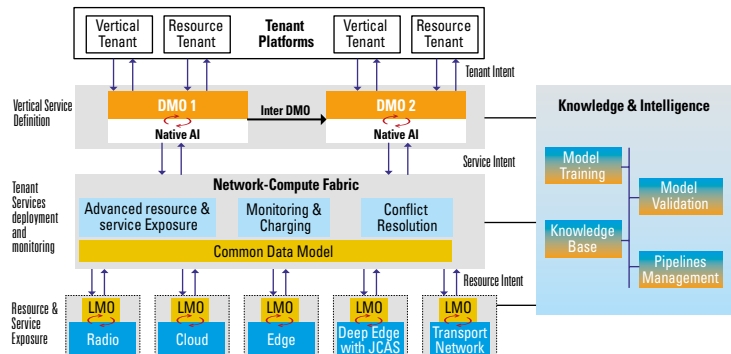

Architecture overview of 6G-INTENSE



CONCEPT/ ARCHITECTURE

6G-INTENSE employs TMForum's architecture, bridging Autonomous Domains (ADs) across business, service, and resource domains. It features Distributed Intent-driven Management and Orchestration (DIMO) for 6G, integrating Deep Edge resources and private networks with non-3GPP protocols. Native AI will be embedded for analytics and knowledge synthesis.

The architecture introduces a Network-Compute Fabric Abstraction

framework to unify Orchestration Domains via intent-based APIs, improving scalability. This abstraction separates service and resource orchestration, supporting Domain Management and Orchestrator (DMO) in service request mapping and Tenant intent reconciliation. Generative AI will merge Deep Edge resources with the Network-Compute Fabric, while sensing capabilities will ensure reliable Deep Edge performance by monitoring link quality and user mobility.

USE CASES/ SCENARIOS

The project has two use cases to display its innovations. The first, **Distributed Continuum for pervasive computing**, aims to validate the Abstraction Framework. This includes deployment, model training, and integration with southbound Compute and Communication platforms, with two scenarios to be tested.

- Pervasive computing in a distributed continuum scenario, which aims to: 1) manage the micro-service deployment as an Orchestration Continuum undertaken by the Network-Compute Fabric after appropriate training of its Generative AI models; 2) demonstrate JCS of the Deep Edge infrastructure (e.g., monitoring links and performance)
- Edge intelligence and compute interconnection scenario, which aims to demonstrate SD-WAN usage for PoP interconnection, Dynamic resource integration to Network-Compute Fabric, SLA

guarantee by intent monitoring, Edge intelligence for training distributed ML models.

The second use-case is **Metaverse** with two scenarios to experiment:

- Joint Communication and Sensing for optimal user tracking in the Metaverse, which aims to: 1) demonstrate the JCS functions that provide pervasive location awareness to be leveraged by Metaverse; 2) explore trade-offs on sensing accuracy vs. energy efficiency at the Deep Edge.
- Fully autonomous Metaverse FCAPS, sensing and continuum abstraction, which aims to: 1) showcase how Native AI mechanisms drive intent (re-) negotiation at the Tenant domain; 2) Deliver the Orchestration Continuum vision at the Service domain; 3) demonstrate adaptation based on the inputs of a Sensing service that is part of the generalised Service Mesh.

EXPECTED RESULTS

6G introduces a complex orchestration of diverse resources – centralised clouds, edge networks, far edge IoT devices, and radio access. Managing these resources cohesively in 6G demands scalable, distributed, and collaborative orchestration mechanisms. 6G-INTENSE's innovative architecture separates service and resource management, using DIMO and Network Compute Fabric, and incorporates AI for Zero-Touch Service Management (ZSM). This architecture

caters to high throughput, minimal latencies, and massive IoT device connectivity with enhanced reliability and resilience. The developments in DIMO, Network Compute Fabric, and Native AI are crucial for Europe's leadership in advanced mobile networks and the digitalisation of industry and public services. Industrial partners in 6G-INTENSE aim to incorporate project outcomes into their products and generate Intellectual Property Rights (IPR).

6G-TWIN

AI-based architecture for the upcoming 6G network, focusing on using Network Digital Twins (NDTs) for real-time optimisation.

OVERVIEW

Networks are becoming increasingly complex and distributed, requiring a large variety of technologies to operate. With 6G, which is now on the horizon for around 2030, it is essential to design, experiment and standardise new network architectures with more intelligence and automation. In this context, **Network Digital Twins (NDTs)** are emerging as essential for testing and optimising scenarios before deployment. However, efforts

to make this concept a reality are still in the early stages.

6G-TWIN will provide the foundation for the design, implementation and validation of an **AI-native reference architecture for 6G systems that incorporates NDT as a core mechanism** for the end-to-end, real-time optimisation, management and control of highly dynamic and complex network scenarios.

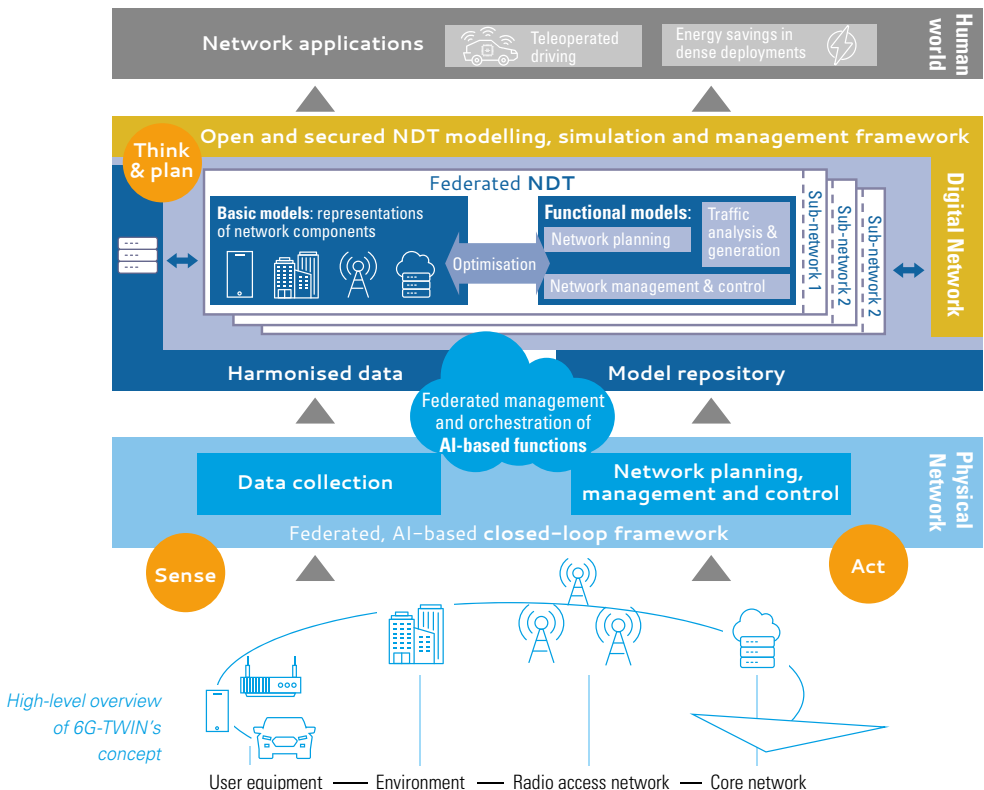

High-level overview of 6G-TWIN's concept

CONCEPT/ ARCHITECTURE

6G-TWIN will deliver methods, modelling and simulation solutions for the **definition, creation and management of multi-layered virtual representations of future 6G systems**, where heterogeneous domains (i.e., edge, fog and cloud) and communication technologies (e.g., cellular, optical and non-terrestrial networks) coexist. The proposed architecture of the project, illustrated in the figure

on the previous page, will rely on a federation of AI-based methods and integrate multiple NDTs for real-time data analytics and decision-making. The NDTs will be designed to reproduce a variety of real-life scenarios with the aim of training and testing functional models to anticipate and/or optimise network behaviours, before they are deployed on physical network controllers and orchestrators.

USE CASE/ SCENARIOS

The project solutions will be demonstrated in two complementary use cases addressing mobility and energy-efficiency challenges:

Demonstrator 1: teleoperated driving. NDT solutions to anticipate the network behaviour that could face a teleoperated vehicle prior to its departure, to ensure an extreme quality of service and availability of the network resources all along its journey (i.e., predictive DT).

Demonstrator 2: energy savings. NDT solutions to adapt the network behaviour in near real time with the objective to optimise the overall, end-to-end energy efficiency of the network (i.e., reactive DT).

These use cases will be implemented in laboratory-sized, low-TRL demonstrators exploiting open approaches, including from the Open Radio Access Network (O-RAN) Alliance and Open RAN communities, to ensure high impact of the project's results.

EXPECTED RESULTS

The project will deliver (figure below) a total of **ten technology components**, including:

- **Federated and AI-native network reference architecture that integrates multiple NDTs** for real-time data analytics and decision-making.
- **On-the-fly AI approaches for orchestrating** network functions (NF) and services (NS).
- **AI-based NF/NS** for data analytics and/or decision-making to optimise network performance.
- Accurate, reliable, open and secured **modelling and simulation framework** for testing the 6G architecture.

Integrating Network Digital Twinning into Future AI-based 6G Systems



Coordinated by Sébastien Faye
Luxembourg Institute of Science
and Technology (LIST)

January 2024 – December 2026

Website: <https://6g-twin.eu/>

X: twitter.com/6Gtwin

LinkedIn: [www.linkedin.com/
company/6g-twin](https://www.linkedin.com/company/6g-twin)

Project Consortium Members:
LIST, IMEC, Politecnico di Bari, Technical
University of Dresden, Université de
Bourgogne, Accelleran, Ericsson, Proximus
Luxembourg, R2M Solution, Ubiwhere,
VIAVI Solutions.



6G-TWIN's technology components

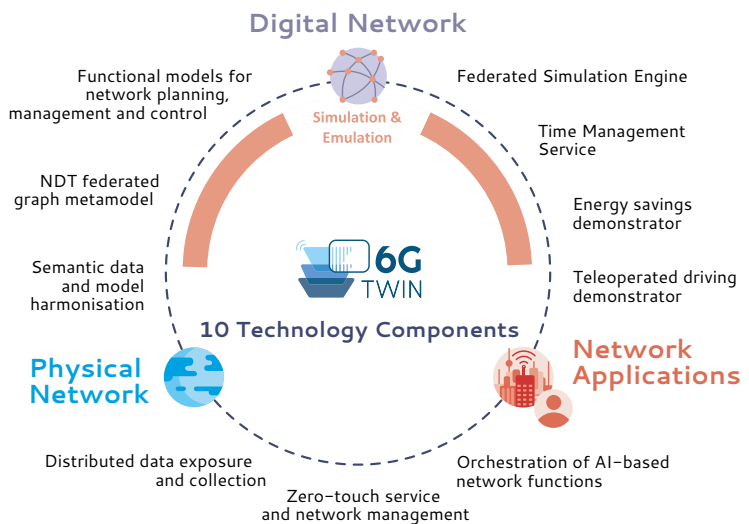

EXIGENCE

Devise & explore a novel approach for energy consumption and carbon footprint reduction of ICT services in the era of next-generation mobile telecommunications (6G).

OVERVIEW

EXIGENCE's overarching goal is to significantly and verifiably improve net energy consumption and carbon footprints of ICT services in the context of next-generation mobile systems (6G), compared to current ICT service provisioning or the logical extension of current paradigms into the future. EXIGENCE aims to move beyond rough, model-based estimations and simple offsetting strategies, like purchasing carbon certificates.

The project focuses on integrating measurement, optimisation, and incentivisation to reduce the overall energy consumption and CO_{2e} of ICT services in future ICT ecosystems.

The project has three key objectives:

1. Conceptualise, design, and implement a system (TRL 4) to reliably assess the energy consumption/

carbon footprint equivalents (CO_{2e}) of the use phase of an ICT service execution/provisioning.

2. Explore, adapt, and develop novel, incentive-compatible energy consumption/carbon footprint reduction mechanisms for both service providers and users.

3. Translate the insights gained into requirements and effective solutions for major, typical ICT domains and systems.

EXIGENCE is carried out by an interdisciplinary consortium covering the entire value chain, enabling the assessment and comprehension of the proposed solution's impact across various system actors.

EXIGENCE is part of the SNS Phase 2 Project Stream B, focusing on System Architecture.

CONCEPT/ARCHITECTURE

EXIGENCE explores, develops, and evaluates a generic end-to-end inter-domain, multi-tenant mobile service delivery architecture and methods to measure and optimise ICT service energy consumption during execution across all participating domains, introducing measures to make users in the entire ecosystem aware of energy usage.

EXIGENCE will employ a relatively simple yet powerful service user/provider pattern, as shown in figure next page. Service User A consumes a service SB from Service Provider B. For this, Service User A uses a local client-side implementation of the overall

service SB, Client(SB), while Service Provider B manages the server-side implementation. Both implementations consume energy, which can be measured only by A or B respectively. In EXIGENCE, the primary assumption is that Service Provider B, along with SB itself, will provide energy measurements related to Service User A's consumption of SB, notably E(ASB).

This pattern is applicable within a single technology/authority domain and across different technology/authority domains. When equipped with common KPIs, it allows for the aggregation of energy-relevant data over heterogeneous domains.

Service-oriented architecture
used in EXIGENCE

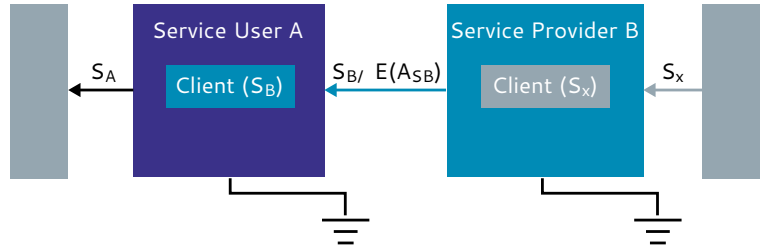

USE CASES/ SCENARIOS

EXIGENCE will validate the results in two testbeds:

- A non-public 5G network in Slovenia, operating in 3.8 GHz band, edge and far-edge nodes and 5G user devices.
- A commercial-graded stand-alone 5G mobile network in Portugal, including an edge deployment.

EXPECTED RESULTS

EXIGENCE will produce the following key exploitable results:

1. An energy-aware ICT metering solution;
2. Reliable inter-domain energy metric exchange;
3. An energy-aware orchestration product;
4. Incentive-compatible energy reduction mechanisms; and
5. Relevant 3GPP contributions for 6G.

The outcomes of the EXIGENCE project activities are as follows:

- Radically improving the resource efficiency of service provisioning, making ICT systems greener by minimising resource overheads.
- Leveraging the usage of green energy resources available and distributed across the network.
- Meeting the requirements of extreme use cases anticipated for the next generation of telecommunication networks.
- Utilising AI/ML technologies to realise a self-driving vision for 6G, automating the optimisation of resources and energy usage.

EXIGENCE

Coordinated by Rita Campos, F6S

January 2024 – June 2026

Website: www.projectexigence.eu

LinkedIn: [projectexigence](https://www.linkedin.com/company/projectexigence)

Project Consortium Members:

F6S Network Ireland, Telefonica ID, Instituto De Telecomunicacoes, National and Kapodistrian University of Athens, TNO, Internet Institute, Communications Solutions and Consulting, ATOS Spain, Huawei Germany, Athens University of Economics and Business - Research Center, Detecon International.



ORIGAMI

ORIGAMI aims at advancing the architectural models of next-generation mobile networks by exploring Global Service-based Architecture, Zero-Trust Exposure Layer and Compute Continuum Layer.

OVERVIEW

ORIGAMI proposes an update of the mobile network architecture model beyond 5G Service-Based Architecture (SBA). As shown in the figure, ORIGAMI introduces three key enhancements and critical architectural innovations – **Global Service-based Architecture (GSBA)**, **Zero-Trust Exposure Layer (ZTL)**, and **Compute Continuum Layer (CCL)** – along with multiple **Network Intelligence (NI)** solutions enabled by these innovations. Through this,

ORIGAMI aims to establish global standards, drive green transition, enhance affordability and accessibility, and catalyse innovative applications and business models.

ORIGAMI aims to forge strong connections with all streams, notably with Stream B (B 01–01), and C's project like 6G–SANDBOX, where ORIGAMI intends to implement PoCs, and Stream D like TrialsNet, from which ORIGAMI plans to draw insights to guide architectural design elements.

CONCEPT/ARCHITECTURE

ORIGAMI introduces a methodology featuring three architectural innovations for global control loops, supporting NI functionalities and services. **The CCL** optimises network functions using computing resources like GPUs, TPUs, and quantum computing. CCL aims for efficient resource utilisation and performance in time-sensitive virtualised networks, offering an API to abstract diverse computing infrastructure, facilitating resource management and avoiding vendor lock-in.

The ZTL in ORIGAMI aims to improve service provider operations in network deployments. It allows operational influence and advanced features like remote sensing and digital twinning. ZTL is comparable to services from computing hyper-scalers like Amazon

AWS and Google Cloud, providing both vertical and horizontal exposure. Vertically, it integrates with 3GPP's data analytics for enhanced network automation. Horizontally, ZTL facilitates global IoT connectivity, tackling international mobile roaming challenges and modernising cellular ecosystem practices.

The GSBA in the ORIGAMI project integrates the CCL and ZTL with legacy domain buses like the 3GPP SBA. GSBA manages services across domains, such as network operators and infrastructure providers, and connects various domain buses. This fosters collaborative and intelligent network operations, enabling more flexible interactions between Service Providers and Network Operators.

USE CASES/SCENARIOS

Advancements in Networks Functions Virtualisation (NFV) and cloud management signal the transition to 5G and beyond. However, to unlock 6G's potential, addressing eight critical barriers is crucial:

1. Unsustainable RAN virtualisation: Current RAN virtualisation relies on costly, energy-intensive hardware, hindering resource deployment.

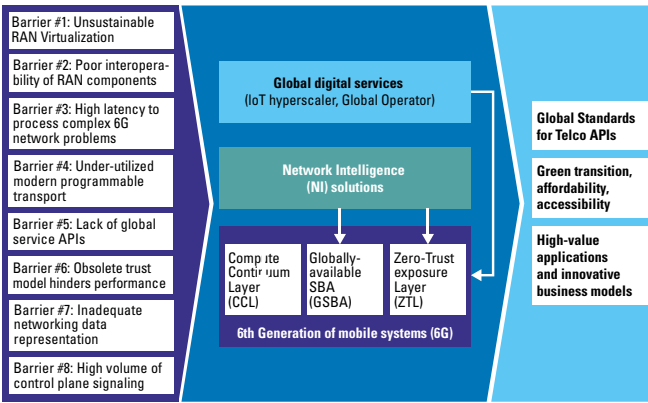

ORIGAMI architecture innovations, which tackle 8 concrete barriers of the current mobile architecture towards 6G

- Poor Interoperability of RAN Components:** Lack of seamless interoperability between open RAN components affects deployment and control.
- High Latency in NI :** Processing complex 6G network problems with low latency impacts operations.
- Under-utilised Modern Programmable Transport:**

Inadequate tools to exploit programmable transport for deploying 6G VNFs.

- Lack of Global Service APIs:** Absence of standardised APIs for global service and monitoring for 6G devices.
- Obsolete Trust Model:** Current trust models hinder scalability due to reliance on pre-established agreements.
- Inadequate Networking Data Representation:** Global data representation challenges make monitoring difficult.
- High Volume of Control Plane Signaling:** Increasing signaling reduces scalability and resilience of the network core.

These barriers involve virtual infra control limits, interoperability issues, global ops support, and billing. Architectural shifts are needed for 6G's advent.

EXPECTED RESULTS

ORIGAMI aims to create novel network architectural extensions for synergistic operation, tackling challenges with three innovations and specific NI algorithms:

- Operator Control Loop:** Extends domain-specific control loops to a holistic network view, unifying domains via the GSBA for intelligent algorithm cooperation under Network Operator policies, enabling operations like global RAN resource orchestration.
- Hyperscale Control Loop:** Introduced by the ZTL, it enhances collaboration between Service Providers and Network Operators, allowing a broader range of network capabilities and service customisation.
- Novel Compute Paradigms Integration:** NI toolbox with scalable learning algorithms and quantum computing for high latency in network intelligence.
- Streamlined U-Plane Computing:** Integrating ML into user-plane programmable hardware to address under-utilised modern programmable transport.
- Global Operator Model with DLT:** Blockchain for dynamic partnerships and real-time billing, addressing global service APIs and obsolete trust models.
- Anomaly Detection: Real-time functionality,** particularly for M2M, addressing inadequate networking data representation.

ORIGAMI's solutions to overcome identified barriers include:

- Data-Driven Task Offloading:** vRAN approach for resource pooling and efficient computing offloading, addressing unsustainable RAN virtualisation.
- Enhanced 6G Management:** Advanced ML models for Open RAN network management, tackling poor interoperability of RAN components.
- Network Core Traffic Analysis/Optimisation:** SCP-enabled 6G core with ML for traffic optimisation, reducing high control plane signaling volume.

These target efficient network management, leveraging ORIGAMI's innovations for a robust, scalable 6G network.

Optimised Resource Integration and Global Architecture for Mobile Infrastructure for 6G



Coordinated by
Javier García Rodrigo
(Telefónica Innovación Digital)

January 2024 – December 2026

Website: <https://sns-origami.eu>

X: @sns_origami

LinkedIn: [linkedin.com/in/sns-origami](https://www.linkedin.com/in/sns-origami)

Verticals concerned : all - IoT

Project Consortium Members:
Telefónica ID, NEC laboratorios Europe, Telecom Italia, EMnify, Fogus Innovations & Services, Cumucore, Is-Wireless, NET AI TECH, University of Carlos III of Madrid, IMDEA, I2Cat, Technical University of Delft



Stream B2

**WIRELESS
COMMUNICATION
TECHNOLOGIES
AND SIGNAL PROCESSING**

The selected projects explore advances such as novel 6G RAN technologies and integrated communication–sensing paradigms.

6G-DISAC

The 6G-DISAC project is aimed at realising Integrated Sensing and Communication (ISAC), surpassing typical standalone scenarios.

OVERVIEW

It adopts a holistic approach, encompassing many connected users and/or passive objects for tracking, and depends on an extensive, intelligent infrastructure. This infrastructure is designed to meet real-world integration

challenges and the flexibility needs of future wireless networks.

The 6G-DISAC project sees possible connections with other SNS projects: TIMES, TERRAMETA, 6G-SENSES, INSTINCT, ISEE-6G, 6G-MUSICAL, HEXA-X-II, 6G-GOALS.

CONCEPT/ARCHITECTURE

6G-DISAC aims for an intelligent, distributed ISAC system, blending theory and operational standards for joint communication and sensing. It's developing an architecture for distributed processing, detecting multiple targets for various applications (see fig. below). This architecture enables tracking of both passive and active objects, requiring new tracking and handover functions. It incorporates semantic communications, new protocols, and

Reconfigurable Intelligent Surfaces (RISs) to enhance capabilities. Focused on AI/ML-based semantic-aware solutions, 6G-DISAC seeks to optimise performance in localisation, sensing, and communication while conserving resources. Design challenges include scalable, adaptive resource allocation methods and integrating large MIMO architectures with AI/ML for complex problem-solving.

The vision of the 6G-DISAC network architecture

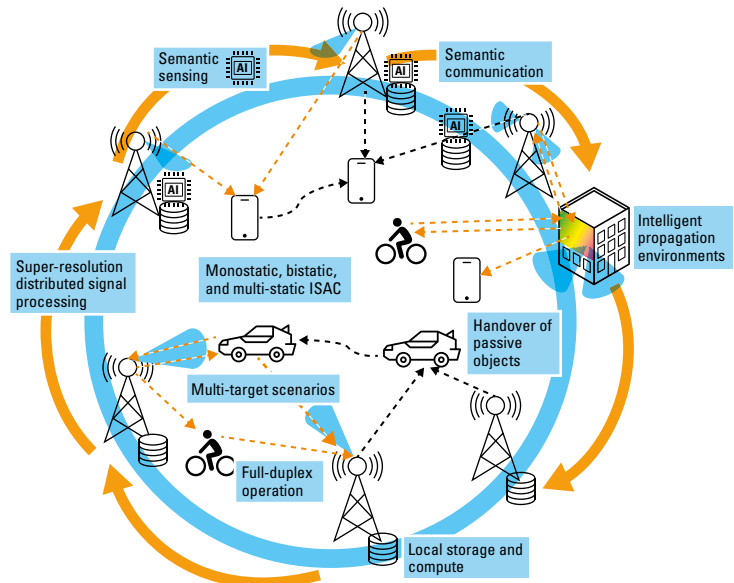

USE CASES/ SCENARIOS

The 6G-DISAC project, with its semantic framework, architecture, and high-resolution processing, targets diverse applications in intelligent transportation, health care, smart factories, and cities. It enhances traffic monitoring, protects pedestrians and cyclists, and provides real-time traffic analysis. The project's high-resolution processing assists in precision

measurements for traffic flow and hazard detection, aiding urban planners. In industrial settings, it enables presence detection, gesture recognition, and improves anti-collision systems. Additionally, its distributed architecture supports environmental analysis in agriculture, contributing to efficient crop management decisions.

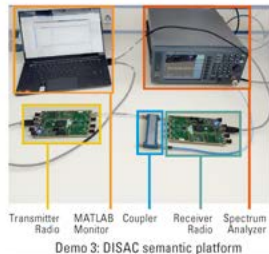
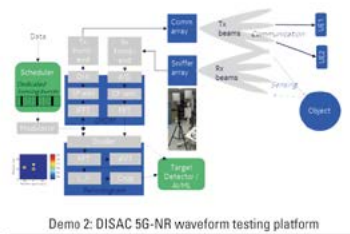
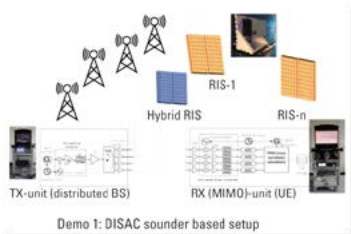

Overview of the five planned 6G-DISAC demonstrations

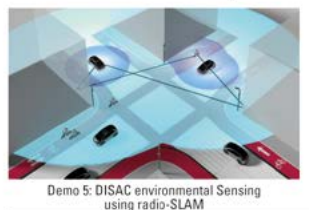
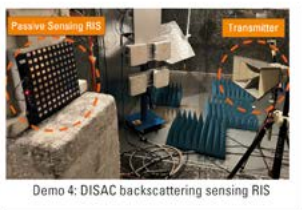

EXPECTED RESULTS

The project plans to define i) new semantic and radio planes, interacting with each other and operating intelligently to provide the required services with minimal overheads and power consumption, while being robust against errors in the radio plane; ii) high-resolution processing and sensing-aided communication that can take advantage of modern multi-antenna technologies (such as massive MIMO and RIS), under constrained distributed processing; iii) new resource allocation schemes and orchestration mechanisms for a large number of distributed entities; iv) the DISAC architecture that can support the lower-layer functions and interfaces with external services; v) finally, several demonstrations, that will validate a wide selection of key 6G-DISAC concepts and applications. The planned demonstrations will support multi-static configurations with distributed sensing capabilities

in indoor and outdoor settings. In particular, the 6G-DISAC project involve five complementary demonstrations covering four testing platforms and one comprehensive trial, as illustrated in the figure above.

The project aims to demonstrate the effectiveness of distributed sensing in improving target detection and identification, including advances in localisation, speed, and tracking. It will show the integration of sensing and communications under different scenarios, including with/without RIS and semantics. 6G, the next wireless communication generation, addresses increased data demand, ultra-low latency, massive connectivity, energy efficiency, and advanced technologies. Enhanced technology in 6G facilitates better connectivity, communication, collaboration, information access, empowerment, community building, and innovation.

6G for Distributed Intelligent Sensing and Communication



Coordinated by
Emilio Calvanese-Strinati,
CEA-Leti

January 2024 - December 2026

Website: www.6gdisac-project.eu

X: @6G_DISAC

LinkedIn: www.linkedin.com/groups/13002293/

Project Consortium Members:
CEA-Leti, Chalmers University,
Nokia, Telecom Italia, Orange, the National
and Kapodistrian
University of Athens,
Bordeaux INP, NEC,
BOSCH, RadChat.



6G-GOALS

6G-GOALS marks a leap towards intelligent and goal-oriented communication, integrating AI to revolutionise network design and data transmission.

OVERVIEW

6G-GOALS will lay the theoretical, algorithmic, and operational foundations of a novel communication and networking paradigm moving beyond the established sense-compute-connect-control models towards semantic and goal-oriented communication based on AI-enabled architectures, protocols, and services. 6G-GOALS challenges the current content-blind transmit-without-understanding approach, where data are transmitted without any prior understanding of

how informative they are for the end goal of communication. Instead, pragmatic and judicious generation, manipulation, storage, and transmission of available information will be integrated into the network design by leveraging the semantic relevance of contextual data and the latest advances in AI/ML technologies.

The 6G-GOALS project sees possible connections with 6G-DISAC and HEXA-X-II.

CONCEPT/ARCHITECTURE

6G-GOALS' system architecture, based on ORAN, enhances 6G with semantic/goal-oriented communication. The subsequent key elements detail the system architecture depicted in figure below. The **Semantic Engine** efficiently delivers semantic-oriented services by managing semantic information resource processing, semantic model life-cycle, and user experience. The **Semantic RIC** platform supports the deployment of semantic-oriented applications, accommodating various

service time requirements from non-real-time to real-time. The **RAN Semantic Plane** coordinates tasks between components and handles semantic information flow. The orthogonal **Application Plane** offers interfaces for semantic applications across edge devices or user equipment. **UE and Edge Components** facilitate semantic information extraction and processing from raw data sources with advanced computational and learning abilities. The **Knowledge Base** supports semantic model development and information interpretation. The **Enhanced Core Network** with key roles for the Network Data Analytics Function and Network Exposure Function, enables semantic functionalities in RAN and management domains.

6G-GOALS aims to advance beyond traditional models, focusing on semantic communication-driven AI. Its pillars are 1) **AI-enhanced semantic data handling**; 2) **Time-sensitive communication for distributed reasoning/actuation** in varied data scenarios; and 3) **6G sustainability via semantic-empowered RAN**

The conceptual 6G-Goals architecture

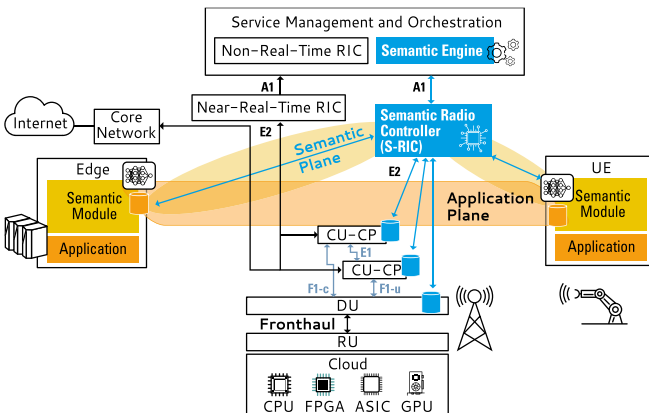

solutions, integrating architectural, theoretical, and algorithmic approaches with intelligent RAN.

Experimental setting of PoC on real-time semantic communication

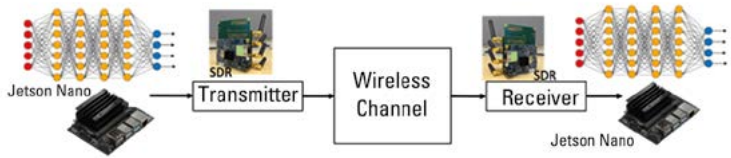

USE CASES/ SCENARIOS

Realistic use cases will validate the achievable performance of semantic and goal-oriented communications, comparing them with conventional schemes via two Proof of Concepts (PoCs): 1) **Hardware Implementation of Semantic Communication** (figure above), which focuses on real-time semantic communication over a wireless channel with bandwidth and power constraints, employing Jetson Nano processors

and software-defined radio (SDR) units. Two scenarios are considered: wireless transmission of data samples for model training and transmission of pre-trained models. The primary focus is on a joint source-channel coding approach to enhance model robustness against channel noise. 2) **Semantic Communications-enabled Cooperative Robotics** (figure opposite), aims to demonstrate improved connectivity driven by semantic communication in cooperative robotics, using low-cost multi-radio, multi-sensory robotic platforms. The trial assesses semantic communication's advantages over conventional methods, leveraging advanced 3GPP-compliant core network and enhanced 5.5G Open RAN system. The testbed includes semantic-aware controllers and components empowered with real-time semantic processing capability for robotic sensor data, facilitating semantic communication, control, and task allocation.

Semantic-aware cooperative robotics PoC

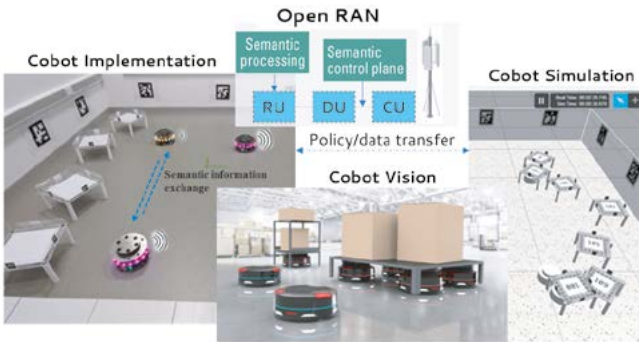

EXPECTED RESULTS

The 6G-GOALS project aims to establish foundations for semantic, goal-oriented communication, focusing on semantic data management and AI reasoning. It explores causal semantic data in temporal contexts and different semantic communication scenarios among AI agents. The project's targets include: i) developing a new network architecture with a semantic plane and modules; ii) defining limits of semantic, goal-oriented communications; iii) devising strategies to optimise connect-compute-sense resources, maintaining compatibility with current systems; iv) establishing

experimental benchmarks via proof-of-concept scenarios.

The push for 6G stems from tech advancements, growing data and connectivity demands, and a need to stay competitive in the digital arena. 6G aims for faster data speeds, higher capacity, and near real-time latency, enabling new applications and improving existing ones. Economic and geopolitical considerations also drive 6G, with a focus on energy-efficient designs and protocols for minimal environmental impact and high performance.

Oriented Ai-Enabled Learning And Semantic Communication Networks



*Coordinated by Emilio Calvanese-Strinati, CEA-Leti
January 2024 - December 2026
Website: 6g-goals.eu*

*Project Consortium Members:
CEA-Leti, CNIT, NEC, TOSHIBA, TELECOM ITALIA, EURECOM, HPE Italia, HPE France, Aalborg Universitet, Imperial College of London, Singapore University of Technology and Design.*



6G-MUSICAL

6G-MUSICAL explores innovative approaches for tightly integrating communication and radio-sensing, paving the way for a paradigm shift towards a perceptive network.

OVERVIEW

6G edge nodes will be equipped with integrated radar-based radio-sensing, working alongside the communication component. This project, centered on technology, sustainability, and impact, aims to establish and assess the business and sustainability aspects of integrated 6G communication and sensing. Technical objectives include defining 6G's network architecture, developing common waveforms for communication and sensing, researching cooperative

MIMO algorithms, creating stable reference sources for RF synchronisation, and designing dynamic resource allocation for optimal radio resource use.

6G-MUSICAL integrates the SNS Stream B: Research for radical technology advancement towards 6G definition.

More specially the focus lies on harmonised communications and sensing.

CONCEPT/ VISION/ ARCHITECTURE

The vision of 6G-MUSICAL

Communications and radar, despite their similarities, have developed separately for decades. Radar has offered localisation and tracking for major organisations, while advancements in wireless

communications have democratised access to various services. Now, with 6G, both services will merge, including a radio-sensing component in the globally deployed network, democratising access to high-quality services previously limited to sophisticated radar users.

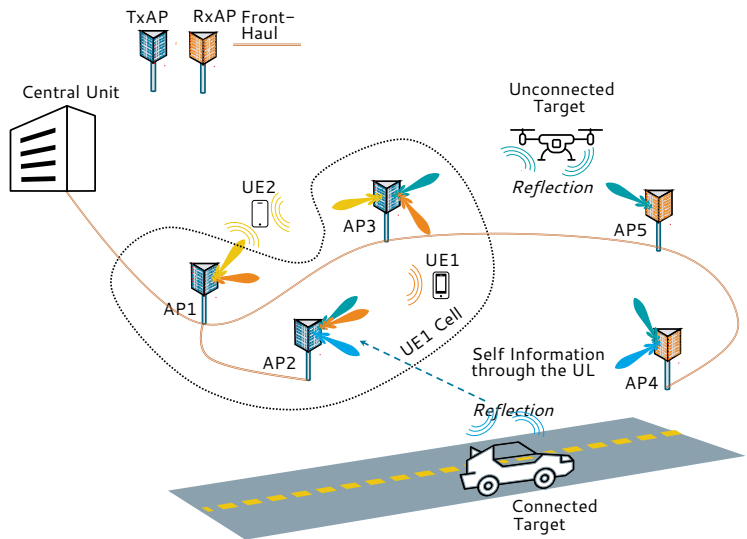

The concept/architecture of 6G-MUSICAL

The figure presents a high-level concept for local deployment that involves a user-centric cell-free scenario, where user equipment (UE) establishes connections with several access points (APs) forming a dynamic cell centred on the user. The figure also showcases the radio sensing sub-network component. For this

component 6G-MUSICAL considers that sensing is based on the bistatic radar concept. In fact, the traditional monostatic concept would require that radio full-duplex technology to be at a very mature stage.

Therefore, sophisticated, localisation, tracking services may become available to the commons. The resulting massification will be the catalyser to spur innovation.

USE CASES/ SCENARIOS

High-accuracy Localisation and Tracking. The 6G infrastructures will provide millions of terrestrial anchors which when working cooperatively may enable sub-cm accuracy at low distances and sub-meter at moderate distances.

Simultaneous Imaging, Mapping and Localisation. Joint imaging, mapping and localisation can enable high-resolution reconstruction of 3D objects. The spatial dimension with multiple nodes cooperating may enable sub cm resolution at short distance if cooperating nodes are accurately synchronised.

Augmented Human Sense. Radio sensing techniques support high-resolution imaging and detection. With 6G networks, these will open the door for numerous applications, such as, detection of slits on products or infrastructures.

Other use cases include traffic monitoring, motion sensing, pedestrian detection, detection and identification of non-authorized objects in sensitive spaces.

The massification and democratisation of radio sensing will be the main driver to spur innovation.

EXPECTED RESULTS

The main expected results are related with the defined objectives and the project expect to deliver tangible results that will advance the definition of the architecture of 6G perceptive network, common waveforms for radio-sensing and communications.

Merging of optical and radio technologies to distribute very accurate and stable reference sources enabling time / frequency synchronisation supporting high accuracy localisation and high-resolution object reconstruction.

6G MULTiband Wireless and Optical Signalling for Integrated CommunicAtions, Sensing and Localisation



Coordinated by Atílio Gameiro,
Instituto Telecomunicações
January 2024 – December 2026

Website: www.6gmusical.eu

X: x.com/6gMusical?s=20

LinkedIn: www.linkedin.com/company/6g-musical/

Verticals concerned:
Automotive, Industry, Smart cities,
Transport and Logistics

Project Consortium Members:
Instituto Telecomunicações, Sodira
Connect, Fraunhofer IZM, eBOS, University
of Dulu, IMEC, Menhir Photonics, Waseda
University, University
College of London,
Ericsson Limited.

Affiliates: Ericsson AB,
Ericsson LMF



6G-SENSES

6G-SENSES proposes Cell-Free Massive MIMO and Integrated Communication and Sensing for advanced 6G connectivity.

OVERVIEW

6G-SENSES proposes integrating innovative 6G Radio Access Network (RAN) technologies, such as Cell-Free massive MIMO (CF-mMIMO) and Integrated Communication and Sensing (ISAC), to support the 6G vision sustained by the current and future architectural framework based on 3GPP and Open RAN (O-RAN). The project considers a multi-technology RAN ecosystem with technologies capable of offering sensing functionalities (3GPP and non-3GPP). These technologies include Sub-6, current and upcoming Wi-Fi releases, millimeter wave (mmWave), and 5G New Radio (NR). They will coexist in an ISAC framework aimed at obtaining a faithful representation of the surrounding environment. This

framework will use new physical layer technologies to increase cooperation between technologies and to enhance the precision of sensing capabilities. To further strengthen communication and sensing functionalities, the project will leverage Reconfigurable Intelligent Surfaces (RISs) and work on the design, optimisation, and modeling of these surfaces. Sensing information from these technologies will be integrated into the O-RAN framework for optimisation purposes.

The project is one of the selected projects of HORIZON-JU-SNS-2023-STREAM-B-01-02, and its topics closely align with those proposed by peer projects INSTINCT, 6G-DISAC, and ISEE-6G.

CONCEPT/ARCHITECTURE

6G-SENSES is advancing 6G RAN technology within a 6G O-RAN/3GPP framework, focusing on:

1. Developing a versatile RAN ecosystem for sensing functions and using CF and MIMO distributed antenna schemes.
2. Utilising RIS infrastructure to boost ISAC and CF-mMIMO, with methods for RIS-assisted links enhancing sensing and availability.
3. Crafting a scalable MIMO mmWave front-end for MIMO and beamforming (BF) in ISAC.
4. Enhancing RIC and control intelligence for cross-domain AI optimisation, including network automation tools and AI/ML-driven optimisation for all RAN layers.
5. Creating AI/ML models for network management and optimisation, predicting traffic using diverse data like network monitoring and user geolocation.

USE CASES/ SCENARIOS

The 6G-SENSES project is dedicated to developing a Technology Readiness Level-5 Proof of Concept (PoC) to demonstrate technological advancements beyond the current state of the art.

PoC #1 involves constructing a small-scale end-to-end prototype to showcase the performance and energy efficiency of ISAC. This prototype consists of an operated Remote Unit (RU), Distributed Unit (DU), and Centralised Unit (CU) / User Plane Function (UPF) pools, controlled in real-time with a sub-millisecond control loop for each network component. As outlined in the figure, this PoC includes several key components:

1. A Service and Management Orchestrator (SMO) to facilitate validation, experimentation, and ensure reproducibility.
2. A network of RUs forming CF-mMIMO, connected to OAI-based disaggregated RAN and CN network functions in the form of container images.
3. Real-time control fabrics enriched with five ISAC control logics: spectrum management, RAN sensing, RAN monitoring, RAN control, and user positioning, enhanced with CN location management functions (LMF) deployed as edge applications, i.e., xApps.
4. 5G-optimised compute nodes, all synchronised using the IEEE 1588v2 Precision Time Protocol (PTP).

EXPECTED RESULTS

6G-SENSES is committed to validating developed algorithms and techniques in experimental prototypes targeting TRL 5. The Key Performance Indicators (KPIs) being assessed are expected to double energy efficiency, achieve sub-centimeter precision in

the multi-technology ISAC framework, and improve throughput by 50%. However, the specific roles of the aforementioned verticals will be detailed in the initial release of 6G-SENSES technical documentation.

SEamless integration N of efficient 6G wireless technologies for communication and Sensing



Coordinated by
Jesús Gutiérrez Terán,
IHP Microelectronics
January 2024 – June 2026
Website: www.6g-senses.eu
X: @6gsenses

LinkedIn: www.linkedin.com/company/6g-senses

Verticals concerned:
Health, Industry, Vehicular

Project Consortium Members:
IHP, University of Cantabria, Accelleran,
OTE, Sapienza University of Rome, Technical
University of Braunschweig, BUBBLERAN,
Barhausen Institut, INTEL Germany,
Nottingham Trent University.



Reference deployment: PoC #1, partially PoC#2 and, conceptually PoC #3

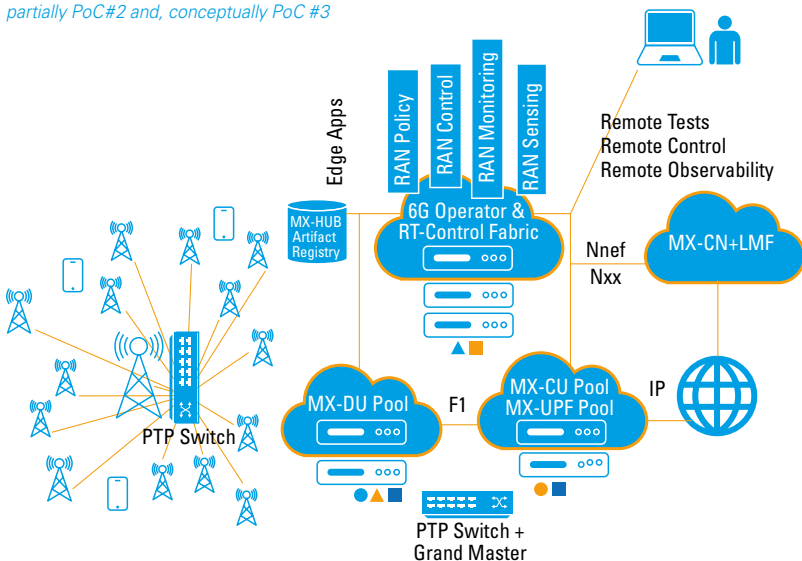

INSTINCT

INSTINCT focuses on developing three technological pillars to achieve a more sustainable, interactive, and intelligent 6G connectivity.

OVERVIEW

The INSTINCT project is going to enable globally sustainable, interactive, immersive, and intelligent 'beyond communications' 6G connectivity by developing three complementary but critical breakthrough technology pillars:

PILLAR I – “Sense-to-communicate”: to substantially improve radio spectrum usage by leveraging sensing information for supporting of novel 'beyond communications' use cases.

PILLAR II – “Communicate-to-sense”: to transform the wireless network into a smart 'sense the world' platform, capable of providing JCAS (Joint Communication and Sensing) –as-a-service functionalities

and materialising the concepts of Electromagnetic Information Theory and wavefront engineering towards a wireless radio 'beyond transmitting bits', capable of sensing, detecting, mapping, and 'understanding' semantics.

PILLAR III – Multi-functional JCAS Network Intelligence: to optimise the architecture, resources allocation, propagation modelling and waveform design with AI-based optimisation of wireless JCAS systems.

The INSTINCT project plans to collaborate with Hexa-X-II and 6G-SENSES projects, also supported by SNS.

CONCEPT/ARCHITECTURE

INSTINCT aspires to deliver the theoretical framework and relevant Key Performance Indicators (KPIs), waveforms, protocols and hardware (HW) design of an innovative beyond communications 6G architecture, which combines the benefits of

Sensing-assisted Communications, Communications-assisted Sensing and the Co-design of Sensing and Communications, leveraging Intelligent Surfaces and AI (artificial intelligence)/ML (machine learning).

INSTINCT system concept for 6G networks

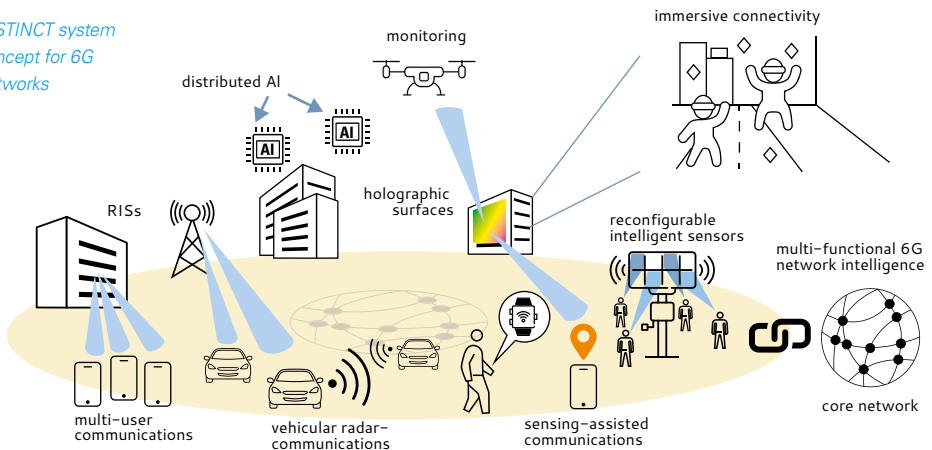

INSTINCT, by means of its 3 pillars, will establish the foundations, invent the enablers and devise new architectures and, thus, offer the cornerstones of a new ICST (Information Communications and Sensing Technologies) era, where IoT meets ICT.

INSTINCT interdisciplinary approach comprises 3-phase methodology (theoretical studies, ecosystem development, demonstration and KPI

evaluation) and will provide 2 HW and 1 software (SW) demo for interactive, immersive and intelligent connectivity in three 6G usage scenarios.

The timeliness and pertinence of INSTINCT impact originates from its relevance to 6G technologies and to recent developments in regulation and standardisation, specially to address the gaps, especially in recent EC funded research (under the SNS JU Call#1 framework).

USE CASES/ SCENARIOS

Usage Scenario 1: I3 (Interactive, Immersive and Intelligent) mobility (Localisation, tracking and traffic management for automotive/drones).

Usage Scenario 2: I3 environment monitoring (localisation/positioning/

imaging/radio environment mapping/surveillance).

Usage Scenario 3: I3 Internet of Senses (augmented human sensing, well-being monitoring, user interfaces, gaming) .

EXPECTED RESULTS

HW Demonstrator 1: JCAS in a sub-6GHz network infrastructure

HW Demonstrator 2: RIS (Reconfigurable Intelligent Surfaces)-aided JCAS using mmWave link (28 GHz)

SW Demonstrator: The objective of the software demonstrator is to extend studies performed in the HW demos towards more complex scenarios and higher frequencies, from sub-6GHz over mmWave up to sub-THz.

*Joint Sensing and
Communications for Future
Interactive, Immersive, and
Intelligent Connectivity
Beyond Communications*

INSTINCT

*Coordinated by Padmanava Sen
(Barkhausen Institut)*

January 2024 – December 2026

Website: cordis.europa.eu/project/id/101139161

*Project Consortium Members:
Barkhausen Institut, University of
Piraeus - Research Center, Robert Bosch,
Aalto University foundation, Fraunhofer,
Greenerwave, NEC Laboratories Europe,
Institut National de Recherche en
Informatique et Automatique, Institut
National des Sciences Appliquées de Lyon,
i2CAT, Oulu University, Centralesupelec -
University Paris-Saclay, Telefonica T&D.*



iSEE-6G

iSEE-6G aims to integrate Communications, Computation, Sensing, and Power Transfer into a unified 6G RAN framework.

OVERVIEW

Joint communication and radar/radio sensing (JCS), or Integrated Sensing and Communications (ISAC), is set to transform wireless communication and sensing. iSEE-6G takes this further, developing a unified Joint Communication, Computation, Sensing, and Power Transfer (JCCSP) radio platform, leveraging 6G technologies. The iSEE-6G framework includes novel antenna/surface solutions

with reconfiguration capabilities, a JCCSP-optimised physical layer aligned with ORAN, cross-layer design for service-oriented architecture, and system-level JCCSP solutions for cell-free 6G networks. The PoC plan targets JCCSP in aerial corridors for UAV coordination, using edge computing for improved positioning and mapping in Public Protection and Disaster Relief (PPDR) scenarios.

CONCEPT/ARCHITECTURE

iSEE-6G's goal is to integrate Communications, Computation, Sensing, and Power Transfer into a unified 6G RAN framework. It involves communication via radio signals, edge offloading for complex functions, object and motion detection through radio waves, and wireless RF power transfer.

Challenges in defining 6G JCCSP include reconfigurable MIMO, intelligent surfaces, mmWave, THz communications, full duplex, Rate Splitting Multiple Access (RSMA), and CRAN/ORAN.

The JCCSP framework will focus on:

- Radio channel evaluation for JCCSP.
- Intelligent surface and antenna array design, exploiting mmWave and multi-band operation for JCCSP.
- Waveform and transmission optimisation considering novel signaling formats and precoding designs.

- Networked sensing and ORAN-based beamforming.
- Cross-layer designs of content placement methods, RSMA, sensing schemes, and stochastic geometry based system-level performance analysis.
- AI application for modelling, optimisation, and decision-making in JCCSP.
- New service components for edge-based positioning and topology management.
- JCCSP experimentation platform development, covering antenna to service with PoC pilots.

The iSEE-6G approach adopts an end-to-end architecture, from physical medium to application.

USE CASES/SCENARIOS

iSEE-6G will identify and describe key use cases at a high level, as well as through a set of conjoint technical operations and functionalities. These use cases will focus on operating UAVs

in a cell-free, user-centric 6G radio environment and defining aerial corridors as a new requirement for 6G-enabling services. The use cases explore aerial corridors where UAVs

with various roles coexist and coordinate, offering different services. The definition of restricted spaces for UAV movement not only increases requirements for accurate sensing and ad-hoc communication among UAVs but also specifies areas where sensing, communication, and energy harvesting should be optimised. The benefits of JCCSP will be showcased, and the applicability of the iSEE-6G platform will be tested through simulation and real-world experimentation.

Two large-scale Proof of Concept (PoC) experiments are planned. The first will feature distributed radio units (RUs) in a vehicular environment supported by UAVs. This JCCSP application scenario involves an emergency response incident, with UAVs monitoring the area, providing accurate positioning, and situational awareness through integrated sensing. The second scenario focuses on UAV-supported IoT with network sensing and the joint exploitation of both novel and existing 5G waveform capabilities.

EXPECTED RESULTS

The expected outcomes of the iSEE-6G project include:

- 6G-enabled JCCSP use case scenarios with aerial corridors as iSEE-6G enablers.
- Channel models for aerial JCCSP systems.
- New types of modulation, multiple-access and physical layer framing schemes that can improve the performance of the JCCSP operation.
- New JCCSP-supporting waveforms – focusing on their time and spectral characteristics, disassociating the investigations from the spatial domain.
- New hybrid beamforming schemes exploiting the achievable DoF towards JCCSP.
- Novel wireless edge caching techniques for JCCSP-enabled 6G networks
- MEC-enabled enhanced positioning and mapping utilising JCCSP data.
- AI-enabled collaborative positioning algorithms with EGNSS fusion and exploitation of results for PPDR operations.
- mmWave beam-scanning antenna arrays and RIS prototypes for the UAV and the terrestrial Radio Units.
- PoC demonstration testbeds for the JCCSP paradigm.

*Integrated Sensing,
Energy and communication
for 6G networks*



Coordinated by Christos Oikonomopoulos-Zachos, IMST
January 2024 – December 2026
X: @isee_6g

LinkedIn: [linkedin.com/company/isee-6g](https://www.linkedin.com/company/isee-6g)

Verticals concerned:
Industry (Agriculture, automation),
automotive, smart cities, health

Project Consortium Members:
IMST, University of Piraeus Research Center, Technical University of Berlin, Airbus DS SLC, IMEC, KU Leuven, WINGS-ICT, University of Cyprus, Orange Romania, Agriculcloud, Mellanox Technologies-NVIDIA, Direk.



*iSEE-6G Layered
Architecture*

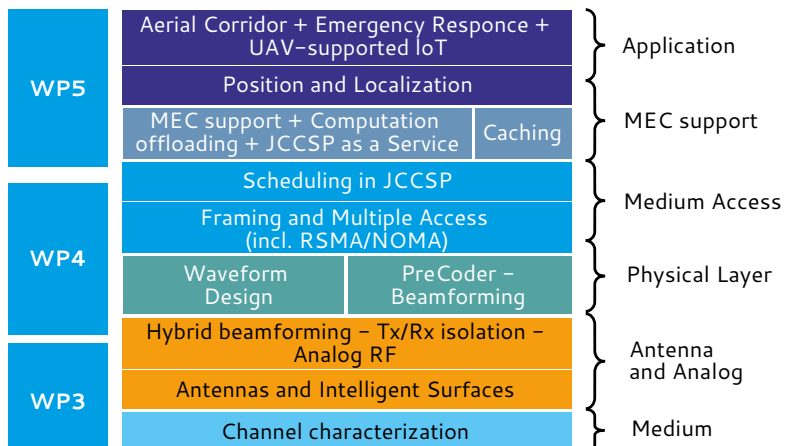

Stream B3

COMMUNICATION INFRASTRUCTURE TECHNOLOGIES AND DEVICES

*The projects have been selected to fortify and expand
the physical and virtual infrastructure to support 6G technologies,
e.g. on optical and wireless.*

6G-EWOC

6G-EWOC focuses on advancing 6G for autonomous driving, improving road safety and efficiency.

OVERVIEW

The sixth generation (6G) of wireless communication technology is heralded as an enabler of our digital age. It offers vast potential for individuals and businesses to enhance opportunities and create new technologies across a broad range of sectors, including industrial manufacturing, energy supply, digital healthcare, government and education, and efficient transportation. 6G-EWOC: AI-Enhanced Fibre-Wireless Optical 6G Network in Support of Connected Mobility, contributes to this mission with a focus on autonomous driving. By connecting vehicles and instantaneously making their collected information available to all traffic participants, 6G provides a key feature for safety and efficient transportation. 6G-EWOC brings critical technologies to the forefront:

- Optical wireless communications and sensing for situational awareness and connectivity.
- Seamless access to edge data centres through a high-capacity fibre fronthaul.
- Real-time processing of collected roadside data.
- Orchestration of various elements of 6G-enabled vehicular connectivity through artificial intelligence.

6G-EWOC is in connection with other SNS projects as: SEASON, ACROSS, HEXA-X II, FLEXSCALE, VERGE, 6G-NTN, SNS-ICE, PROTEUS-6G, 6G-REFERENCE, 6G-BRICKS, 6G-SANDBOX, NANCY, ECO-eNET, TeraGreen, SUNRISE-6G, 6G-SENSES, 6G-INTENSE, ENVELOPE, and 6G-PATH (coordinated by OTE).

CONCEPT/ ARCHITECTURE

Road safety, a major concern in modern society, sees about 1.2 million lives lost annually due to accidents, with significant non-fatal injuries impacting children and young adults. Connected and automated driving, using real-time information for enhanced awareness, can reduce this toll and improve transportation efficiency. Addressing this requires substantial information processing, necessitating upgraded networks with advanced sensors, seamless connectivity, and powerful computing for real-time data analysis.

This study emphasises optical wireless communication for vehicle communication and explores technologies like LiDAR/RaDAR for detection and ranging. It also looks into electrical ASIC and photonic integrated circuit advancements. The 6G-EWOC project focuses on software-defined networking for adaptable networks and AI for network resource management. Additionally, it investigates AI's role in autonomous vehicles with diverse sensors.

USE CASES/ SCENARIOS

To put the concept into perspective, cars' ability to quickly sense their surroundings is advancing, enabling autonomous driving. The next step

involves developing autonomous cars with driving capabilities surpassing human abilities. These cars must recognise objects, vehicles, and

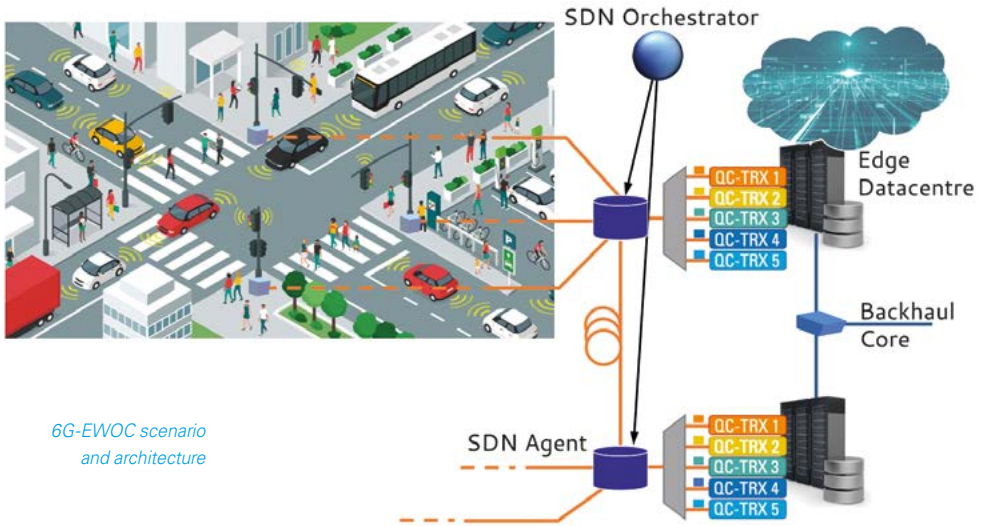

6G-EWOC scenario and architecture

pedestrians nearby, understanding their distance, speed, and direction. With this data, the car's intelligence can determine the safest route for occupants and pedestrians. It will also

identify blind spots and challenging scenarios, like objects or vehicles obstructing the driver's view of a pedestrian crossing, which often cause auto and pedestrian accidents.

EXPECTED RESULTS

A number of designs and prototypes are currently being developed. One example is the photonic integrated circuit for optical beamforming, which the Austrian Institute of Technology is developing (AIT), shown in the figure below.

On the other hand, the ideal scenario is both autonomous and human-driven vehicles equipped with real-time maps including comprehensive 3D information on streets, traffic, and all entities like vehicles, people, animals, and objects. For this, "connected" vehicles are necessary, capable of exchanging large data volumes from their sensors with other vehicles and computing centres. These centres then merge data from various vehicles' RADAR, LiDAR, and cameras in real time. The 6G-EWOC initiative aims to develop robust networks for connected mobility using laser sensors, wireless optical communications, and high-capacity optical fibres. AI techniques are employed to manage data traffic and combine car data from different regions to create 3D maps, ensuring safe driving with detailed, real-time maps, thus enhancing vehicle connectivity and safety.

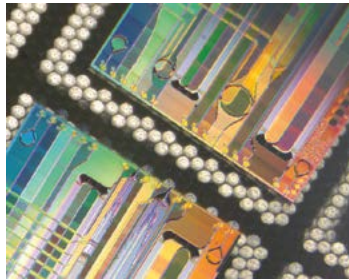

Photonic integrated circuit for optical beamforming

AI-Enhanced Fibre-Wireless Optical 6G Network in Support for Connected Mobility



Coordinated by José Antonio Lázaro, Polytechnic University of Catalonia

January 2024 – December 2026

Website: 6g-ewoc.eu

LinkedIn: www.linkedin.com/in/6g-ewoc-project/

Verticals concerned :

Connected and future autonomous vehicles employing multiple sensor technologies

Project Consortium Members:

Polytechnic University of Catalonia- BarcelonaTech, CTTC, Austrian Institute of Technology, III-V Lab, Ligentec, Beamagine, Bifrost Communications, Nokia Bell Labs, NVIDIA, Magna, Cosmote.



ECOeNET

The ECO-eNET project pioneers in 6G transmission technologies, merging optical and radio transport for an efficient edge network.

OVERVIEW

The ECO-eNET project is pioneering research in emerging transmission technologies to form a new confluent edge network that brings together optical and radio transport to scale to new levels of efficiency and capacity for 6G. It integrates confluent front-/mid-/back-haul (xhaul) with cell-free and distributed multiple input, multiple-output based access networks. The combination of photonic Radio Fixed Wireless (RFW) and Free Space Optical (FSO) transmission is used for fixed wireless connections, enabling the creation of an edge

mesh network. New monitoring and slice-aware control protocols unify the radio intelligent controllers with the transport software-defined networking for optimal service delivery. This project leverages a mix of wired and wireless transport, incorporating an AI layer to manage network functions and process user applications more efficiently. Coordinated by an interdisciplinary team of industry and academic partners, it aims to maximise emerging tech for 6G's capacity, energy efficiency, low latency, and robustness.

CONCEPT/ARCHITECTURE

ECO-eNET's confluent networking uses RFW, FSO, and Flex grid DWDM fibre optics for xhaul networks, primarily focusing on confluent mesh networking. The project will study ten networking technologies (A-J in the figure next page). ECO-eNET's goals include Confluent transmission technologies: exploring RFW at THz frequencies, FSO, and DWDM fibre optics for 6G performance, innovating with plasmonic transceivers for energy-efficient RFW links and developing a transparent fibre-FSO interface with adaptive photonic components. Optical Spectrum as a Service (OSaaS) facilitates signal multiplexing and integration with edge computing, enhancing network optimisation and introducing new sensing-based services. Control and orchestration methods for confluent networking: Enhancing capacity, energy efficiency, and latency through advanced control of new physical layer solutions. This

includes efficient provisioning using existing and new controllers for wireline, radio, and compute, and an AI-enabled orchestration layer. AI services will utilise network sensing for environmental data, supporting applications, and optimising networks. Demonstration of key technologies and network concepts: ECO-eNET will combine technologies and control solutions through lab and field experiments to explore their potential and limitations. Initial experiments will focus on testing sub-THz RFW and FSO wireless systems to create an outdoor link, examining their performance under various weather conditions and aiming for 1 Tbps transmission over 1 km. Additionally, the project will explore the use of fibre sensing for resource allocation in wireless and wired networks and evaluate AI-based control for optimising energy and latency in an OSaaS x-haul mesh network.

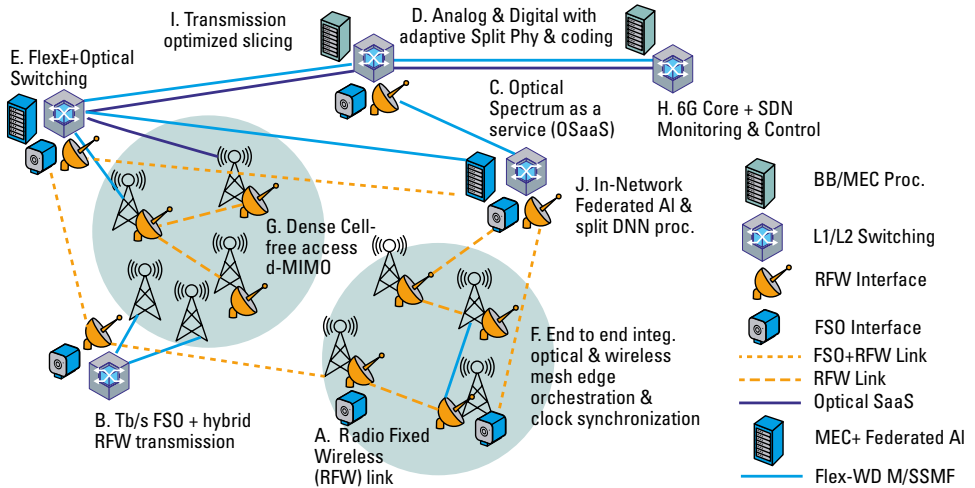

Confluent mesh networking including ten technologies investigated in ECO-eNET

USE CASES/ SCENARIOS

The project will concentrate on two main use case groups. The first involves scenarios requiring high data rates (1Gbps to 10Gbps) for applications like immersive XR and holographic communications, focusing on enhanced, human-centric interactive

experiences. The second category targets machine communication needing extremely low latency (<1ms) for critical local communications and advanced Industry 4.0 applications, including collaborative robotics.

EXPECTED RESULTS

ECO-eNET's confluent networking technologies will enable new supply chains and markets, offering terabit-per-second capacity without higher energy use and significantly lower latency for new applications. The shift towards a mesh edge architecture in wireless networks boosts scaling,

performance, and resilience, facilitating the EU's leading role in deploying these technologies. This progress will connect more people across Europe with high-speed, intelligent network services, increasing accessibility in previously unreachable areas.

Efficient Confluent Edge Networks



Coordinated by Paolo Monti, Chalmers University of Technology

January 2024 – December 2026

Website: eco-enet.eu

X: @ECO_eNET

LinkedIn: www.linkedin.com/company/eco-enet/

Project Consortium Members: Chalmers University of Technology, Trinity College Dublin, University of Bristol, IASA, ETH Zurich, Tallinn University of Technology, Accelleran, mBryonics, Polariton Technologies, ADTRAN, Cosmote.



OPTI-6G

OPTI-6G's ambition is to design, develop and exhibit the operation of a radio optical 6G

OVERVIEW

The OPTI-6G project provides a broadband Optical Wireless 6G Communications (OWC) Vertical Cavity Surface Emitting Laser (VCSEL) array solution, shown in figure on next page, that operates in the near InfraRed (IR) 1550 nm wavelength that does not suffer from interference because of the propagation characteristics of EM waves in this part of the spectrum and provides universal broadband coverage within buildings from a cell-free network of OWC access points that are pervasively located within buildings. This broadband

system, shown in the figure below, will provide 1 Gbps data rates for distances up to 5 m over a field of emission of 25° and 3 Gbps with an angle of 15° and paves the way towards a beam-steered OWC system that will ultimately produce much wider access angles.

The system will be supplemented with a sub cm location measurement and sensing solution, whose accuracy has already been proven at 3.5 GHz. The performance of near IR OWC solution will be compared with the alternative 3.5 GHz 5G radio solution.

ARCHITECTURE/ TECHNOLOGIES

The challenge that is addressed by OPTI-6G project is to design low cost, cell-free near IR networks that can be configured to implement multi-connectivity thereby improving link quality and resilience, whilst obviating the need for building owners to subdivide their non-public mobile in-building network into cellular areas, and the need to access licensed spectrum since the system operates at the optical unlicensed bands and its AI based

distributed scheduler manages any interference between inside and outside access. The novelty of using VCSEL arrays is that such a solution is more resilient to interference from natural visible light emissions providing a truly robust solution.

It has been shown by OPTI-6G project partners in the preceding 6G BRAINS project that user equipment terminals can be located with a few cm

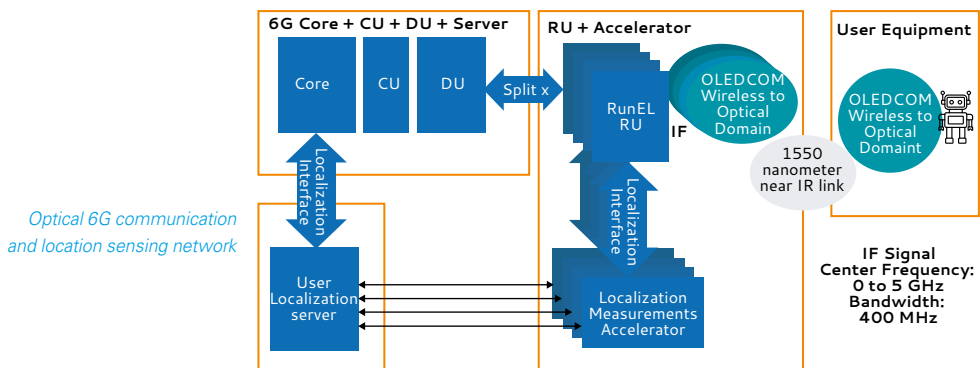

Current optical antenna used in cell-based LiFi systems

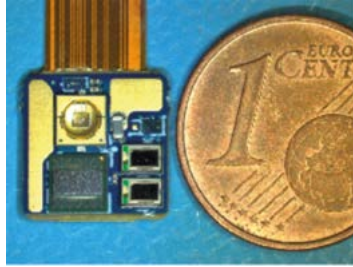

accuracies using Time Difference of Arrival (TDoA) by analysing OFDM Pseudorandom Noise (PN) sequence in a 5G sub 6 GHz carrier frequency

localisation system. Currently, existing OWC localisation solutions that use Received Signal Strength (RSS) alone do not achieve better location accuracy than 1–3 cm, which is not sufficient for automated guided vehicles (AGVs), extended reality (XR) Headsets, drones, IoT devices and robotic use cases, so this will be enhanced by combining it with Angle of Arrival (AoA) and/or TDoA to explore whether a higher accuracy can be obtained. The benefits of these localisation technologies at near IR OWC will be compared with an existing 3.5 GHz localisation solution.

USE CASES/ SCENARIOS

Far-reaching benefits of this architecture are that its common OWC in-building network resources can be more easily shared between MNOs by slicing and that the networks functions virtualisation (NFV) solution provides an Application Programmers Interface (API) that allows third party service providers to write specialised network applications to manage multi-MNO networks in homes, businesses and public space buildings and environments such as tunnels, train stations and airports.

The challenge that is addressed by OPTI-6G project is to design low cost, light weight, low electronic footprint OWC Remote Units (O-RUs) that can be elegantly integrated into near IR access points and whose receivers can be integrated into a myriad

of user equipment such as extended reality headsets, drones, robots, AGVs etc. and compare it with an existing 3.5 GHz 5G cell-free network solution. The main benefit is the availability of broadband communications services greater than 1 Gbps ubiquitously available throughout buildings from pervasively located OWC license free access points.

5G mobile network users will significantly benefit as they will have the choice of a wider range of network services from third party network and home services providers who for example could provide substantially higher bit rates using OWC frequencies at indoor environments, whilst also significantly reducing the level of EM exposure.

EXPECTED RESULTS

OPTI-6G project will significantly benefit 5G MNOs as it will considerably reduce EM interference that would have otherwise been generated by Home gNBs, thereby increasing throughput in the wider 5G mobile network and improving mobile access to users within buildings without incurring interference with the wider 5G mobile network and thus increasing the value of their customers' buildings.

The net result is that there will be a considerable reduction of transmission power and EMF radiation levels, so the user equipment will potentially consume only one tenth of the energy, resulting in 90% energy savings, a tenfold increase in battery lifetime during use in buildings. This will be compared with a corresponding sub 6 GHz solution. The combined effects of a reduction in delay spread due to smaller room geometries, the adapted 3GPP 5G approach and the considerable reduction in propagation delays is expected to result in a reduction in latency to within 1 ms.



Optical 6G Cell-Free Networks (OPTI-6G)

Coordinated by Adam Kapovits, Eurescom
January 2024 – December 2026
Web: opti-6g.sns-ju.eu/
Verticals concerned :
Industry 4.0

Project Consortium Members:
Eurescom, Brunel University London,
University of Paris-Saclay LISV,
Oledcomm, RunEL.



PROTEUS-6G

PROTEUS-6G aims to design and develop a dynamic, flexible, scalable, cost-effective, high-bandwidth, and low-latency packet-optical fronthaul and midhaul for 6G networks.

OVERVIEW

- The PROTEUS-6G project objectives and goals are summarised as follows:
- Development of a novel Spatially-Diverse Point-to-Multi-Point (SDPtMP) optical fronthaul distribution network. This will be driven by an innovative optical device that optically carves out transmitted digital subcarriers using an array of sharp optical interleaving filters acting as circular subcarrier mux/demux. Next-generation Digital Subcarrier Multiplexing (DSCM) transceivers will be utilised for dynamic functional split up to option 7-2.
 - Creation of innovative ultra-high-speed, low-latency, low-cost, and power-efficient Lite-Coherent (LITECOH) transceivers (TXRs). These will be key enablers for the realisation of cell-free MIMO, aiming to achieve ultra-high fronthaul capacities as required in functional split option 8, enabling 6.4 Tbps per fibre over 8 wavelengths.
 - Establishment of a novel service management, orchestration, and control system. This system is essential to enable dynamic reconfiguration of the functional splits in the Radio Unit (RU)/Distributed Unit (DU)/Centralised Unit (CU).

CONCEPT/ARCHITECTURE

PROTEUS-6G focuses on the development of advanced packet-optical x-haul networking infrastructure, relying on novel software-programmable photonic-integrated-circuit based subsystems and technologies operated under an intelligent software management architecture, capable of simplifying and optimising network operations and supporting future ultra-high capacity, low-latency, energy-efficient 6G cellular and cell-free MIMO radio access network.

USE CASES/SCENARIOS

Scenario: will showcase dynamic functional splits, swiftly adapting the functional splits based on the dynamic traffic changes, new services, etc. The envisioned options range from split option 1 up to option 7.2. Realising this scenario will require novel highly flexible, reconfigurable photonic transport, namely point-to-multipoint transponders, SDM/WDM ROADMs, and subcarrier mux/demux.

Under scenario: will provide functional split option-8. Such scenario imposes upon the fronthaul photonic distribution network high-capacity requirement, linearly increasing in the number of distributed antenna arrays (RUs), as well as and nearly deterministic low-latency demands. In PROTEUS-6G this will be enabled by high-capacity lite-coherent transceivers.

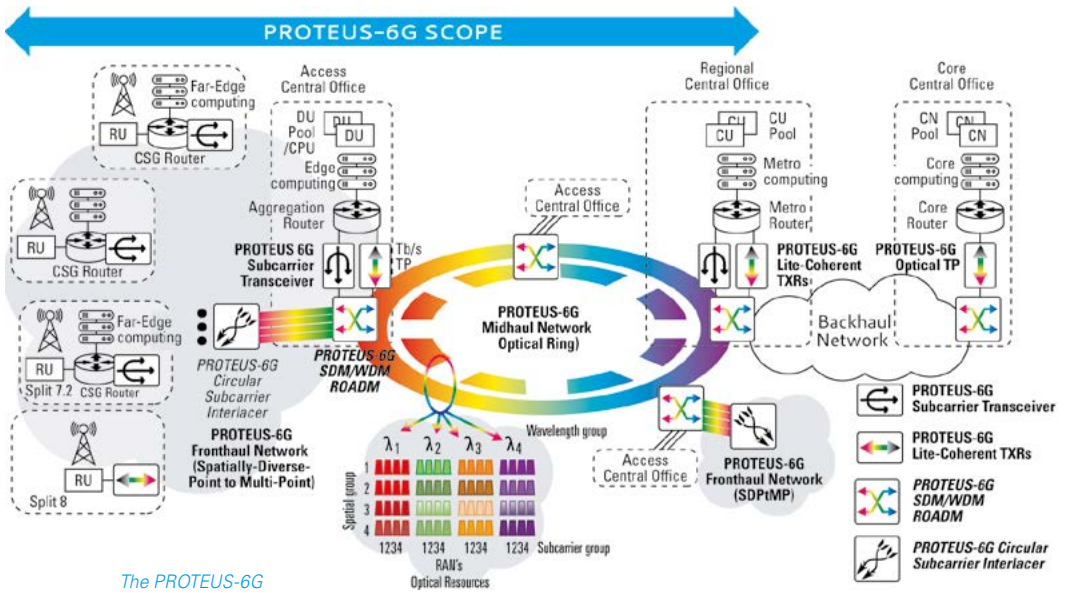

The **PROTEUS-6G** innovations and supported scenarios.

EXPECTED RESULTS

1. Development of access networks, focused on different set of devices, expanding the reach of 6G and reducing its environmental impact.
2. Advances in long distance communications enabled by the adoption of PROTEUS-6G flexible, ultra-fast topology, energy-efficient transceiver architectures based on coherent detection with simplified DSP.
3. PROTEUS-6G introduces an SDPMP reconfigurable fronthaul network, using digital subcarrier-based granularity within the future 6G O-RAN to ensure low latency.
4. Ultra-low energy solutions for devices, including battery free device capabilities.
5. Ultra-low energy and ultra-high capacity solutions for access or end-to-end connectivity.

The transition to 6G marks a shift towards a fully intelligent and energy-efficient network, essential for increasing capacity, reducing latency, and improving communication reliability, while also enhancing network sustainability. This shift involves integrating lossless subsystems into communication networks, representing a new operational paradigm. A major challenge in this transition is managing big data. The core of network intelligence lies in the continuous, distributed collection, preprocessing, and analysis of vast data volumes across multiple data centres within the network infrastructure.

Programmable Reconfigurable Optical Transport for Efficiently offering Unconstrained Services in 6G

PROTEUS 6G

Coordinated by Tomkos Ioannis, University of Patras

January 2023 – December 2025

Website: <https://proteus-6g.eu/>

LinkedIn: www.linkedin.com/company/proteus-6g/

Project Consortium Members:

University of Patras, CNIT, CTTC, Hebrew University of Jerusalem, Lionix INTERNATIONAL, Opsys Technologies, PICadvanced, UBITECH, Telefonica I&D, Fraunhofer HHI, INFINERA, UC3M, Polytechnical University of Zürich, Polariton Technologies.



Stream B4

RELIABLE SERVICES AND SMART SECURITY

The projects have been selected in such a way as to ensure a secure transition to 6G that prioritises user data protection and privacy, reliability, trust and resilience.

iTRUST6G

Revolutionising 6G security with a zero-trust architecture, employing AI/ML for dynamic threat management, and improving trust through innovative identity models and advanced security policies.

OVERVIEW

iTrust6G will design a zero-trust architecture for 6G, enhancing trust through AI/ML for threat management, security policy clarity, and asset tracking. It aims to refine trust establishment methods, enhance security procedure performance, and minimise network resource overhead. The project utilises AI/ML for security and trust management and control layer threat mitigation, focusing on persistent monitoring

and actuation with programmable security. Intent-based security policies will be developed for automated E2E security orchestration. It includes novel Trust Algorithms leveraging AI in a trust management system, focusing on service conception, stakeholder identity, and software supply chain trust. iTrust6G will create an identity management model for stakeholder trust and improve 6G service decision-making using cyber-threat intelligence.

CONCEPT/ARCHITECTURE

iTrust6G's framework encompasses infrastructure, network service, and application domains, based on key architectural principles:

- Zero-trust with AI/ML for threat detection and prediction.
- Ongoing threat assessment and compliance for asset safety.
- AI/ML-driven, intent-based security for clear E2E security orchestration.
- Enhanced monitoring through programmable interfaces and secure multi-tenancy.

Technological pillars include AI-driven orchestration, AI-enabled trust, programmability, and intent-based policy, streamlined through a cloud-native approach for reduced complexity.

Key aspects:

- Continuous trust evaluation using AI/ML in complex, multi-infrastructure environments, integral to the trust management plane.
- Up-to-date threat assessment for persistent asset protection, part of the trust management process.
- Comprehensive end-to-end security orchestration for analysis and action planning, user-friendly with explainability and intent-based security specification.
- Programmable security for enhanced resource monitoring and pervasive countermeasures.

The figure next page depicts a high-level view of the iTrust6G architecture and highlights the key technical enablers.

Intelligent Trust and Security Orchestration for 6G Distributed Cloud Environments



Coordinated by Mir Ghoraiishi, Gigasys Solutions

January 2024 – June 2026

Website: www.sns-itrust6g.com/

X: @iTrust6G

LinkedIn: www.linkedin.com/in/sns-itrust6g-project-1342a92a8/

Project Consortium Members:
Gigasys Solutions, i2Cat, Telefonica, Lenovo, National Technical University of Athens, Greece, Polytechnical University of Turin, PDMFC, Adrestia



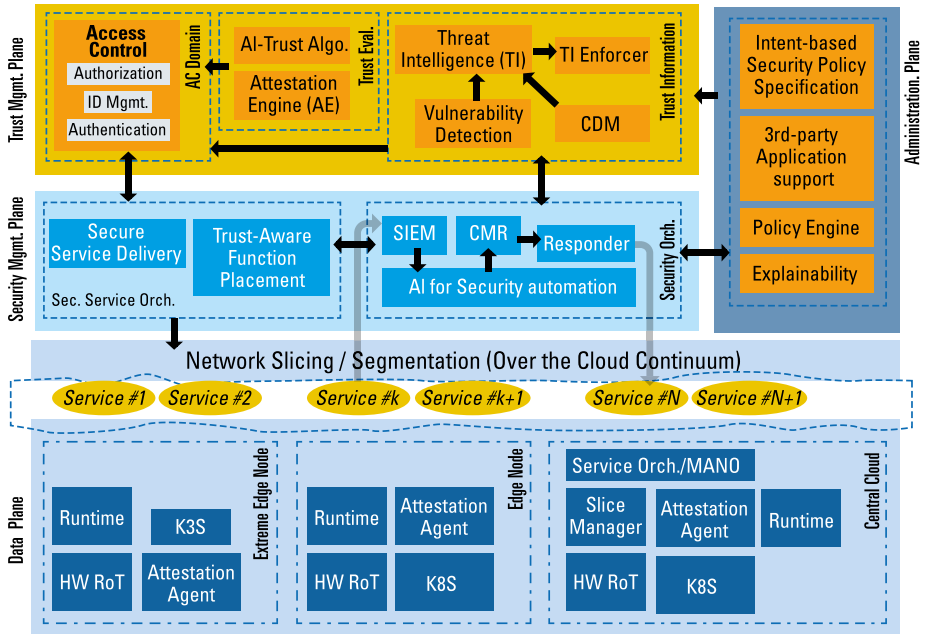

High-level view of iTrust6G system architecture, components, and their relationships

USE CASES/ SCENARIOS

iTrust6G will combine design, specification, implementation, and testbed demonstrations. Key use cases are:

1. Dynamic security orchestration and trust in a multi-stakeholder, multi-domain setup, validating intent-based security and trust establishment.
2. Operational security and trust reassessment, testing robustness against attacks, focusing on detection, mitigation, and forensics.
3. Programmable security as a service, confirming flexibility of security mechanisms in response to application service status.

EXPECTED RESULTS

iTrust6G will achieve these outcomes:

- An end-to-end security architecture using zero-trust for reliable, open 6G service management in the cloud.
- An AI framework for novel threat detection and cyber-threat generation in collaborative 6G.
- Advanced trust algorithms using AI for security assessment based on resource integrity, slice ownership, and supply-chain indicators, impacting resource management and authorisation.
- AI-driven security orchestration for efficient threat management across the cloud continuum, enhancing resource monitoring and security in multi-layered 6G.
- Intent-based security policy engine for clear, automated E2E security orchestration in dynamic settings, defining trust and security processes.
- A dynamic, configurable network function placement solution over network slices and applications for secure service design and delivery.

NATWORK

NATWORK aims to establish and implement the first economically feasible, energy-efficient, and effective bio-inspired, AI-driven cybersecurity and resilience framework specifically designed for 6G networks.

OVERVIEW

NATWORK aims to establish and implement the first economically feasible, energy-efficient, and effective bio-inspired, AI-driven cybersecurity and resilience framework specifically designed for 6G networks. NATWORK aims to provide intelligent networking and services by adopting a holistic approach of different technologies, considering the multifaceted nature of cross-sector business environments of 6G ecosystems.

By leveraging bio-inspired mechanisms and AI, NATWORK aims for real-time security and adaptability, including protection against Physical Layer threats. This approach enhances 6G networks' trustworthiness, resilience, and security, aligning with sustainable development goals.

NATWORK will elaborate activities with other SNS projects including FIDAL to provide future 6G cybersecurity use cases.

CONCEPT/ ARCHITECTURE/ TECHNOLOGIES

NATWORK's architecture, presented in the figure next page, is an open, modular ICT structure integrating orchestration tools, network and security functions, AI, and Federated Learning agents. Distributed across a federated cloud-to-edge continuum, it ensures efficient management and surpasses centralised models. It supports peer-to-peer orchestration and AI-driven decision-making for rapid threat mitigation and energy-efficient operations. The microservices-based architecture is scalable and adaptable for 6G network demands.

Key innovations in NATWORK's 6G cybersecurity include:

- **Decentralised Orchestration Services:** Energy and latency-aware, optimising workload deployment with AI for energy optimisation.
- **Energy Efficient AI services:** Developing anti-jamming techniques using Reconfigurable Intelligent Surfaces (RIS) and MIMO technology for dynamic threat response. Includes Security-compliant Slice Management, IDS, AI-based behavioral analysis, and Moving Target Defense (MTD).
- **Network Services:** Real-time monitoring, P4-based Network Analytics, and Distributed Ledger Technologies (DLT) for robust network defense.
- **Distributed Federated Learning Services: Enhancing data privacy and security** with a secure, distributed machine learning approach, reducing single failure points.

*Net-Zero self-adaptive
activation of distributed
self-resilient augmented
services*

NATWORK

Coordinated by
Anastasios Drosou
& Antonios Lalas, CERTH

January 2024 – December 2026

Website: www.network-project.eu

X: twitter.com/NatworkProject

LinkedIn: www.linkedin.com/company/network-project/

Verticals concerned :
Industry & IoT, Vehicular, Energy,
Defence & Security

Project Consortium Members:
Centre for Research and Technology Hellas,
Gradient, Solid Shiel, CNIT, IS-Wireless,
Eötvös Loránd University, Montimage,
IMEC, NEC, NOVA, PNET, Zurich University
of Applied Sciences, University of Zurich,
University of Essex



USE CASES/ SCENARIOS

NATWORK features a range of use cases, scenarios, and applications for testing and validating solutions in various lab settings, crucial for proving its effectiveness in improving 6G network security, sustainability, and reliability.

Use Case #1: Sustainability and Reliability of 6G Slices and Services Focuses on demonstrating NATWORK's ability to ensure 6G network slice and service sustainability and reliability. Challenges include dynamic energy and security regulation using scalable AI techniques.

Use Case #2: Anti-jamming Technologies for AVs Centres on autonomous vehicle (AV) resilience against jamming, exploring

multi-antenna systems and AI for jamming detection, mitigation, and adaptive modulation, protecting spectrum bands.

Use Case #3: IoT Security Targets the security of massive IoT deployment in 6G networks, involving AI-based IDS, AI-driven Penetration Testing, Vulnerability Assessment, and Blockchain-based Security and Trust Management.

Use Case #4: Improving Network Variability with Continuous Security Aims to boost dynamic 6G network adaptability and security using SDN, NFV, Software-Defined Radio, AI-assisted network slicing, efficient resource utilisation, microservices orchestration, and MTD.

EXPECTED RESULTS

The NATWORK project aims to revolutionise 6G network development by integrating advanced security solutions and AI-driven security management, focusing on physical layer security with robust anti-jamming technologies. It targets energy efficiency and sustainability, striving for net-zero operation in accordance with EU environmental objectives. Societally, NATWORK enhances trust and transparency in 6G services, contributing to societal well-being and resilience against cyber

threats. Economically, it aligns with EU regulations like GDPR and the Cybersecurity Act, fostering market opportunities and economic growth within the European digital market. The project also seeks to influence 6G standardisation and policy, promoting EU's technical excellence and education, supporting the EU's low-carbon goals, and illustrating a comprehensive approach to a secure, sustainable, and efficient 6G ecosystem, reinforcing Europe's global 6G leadership.

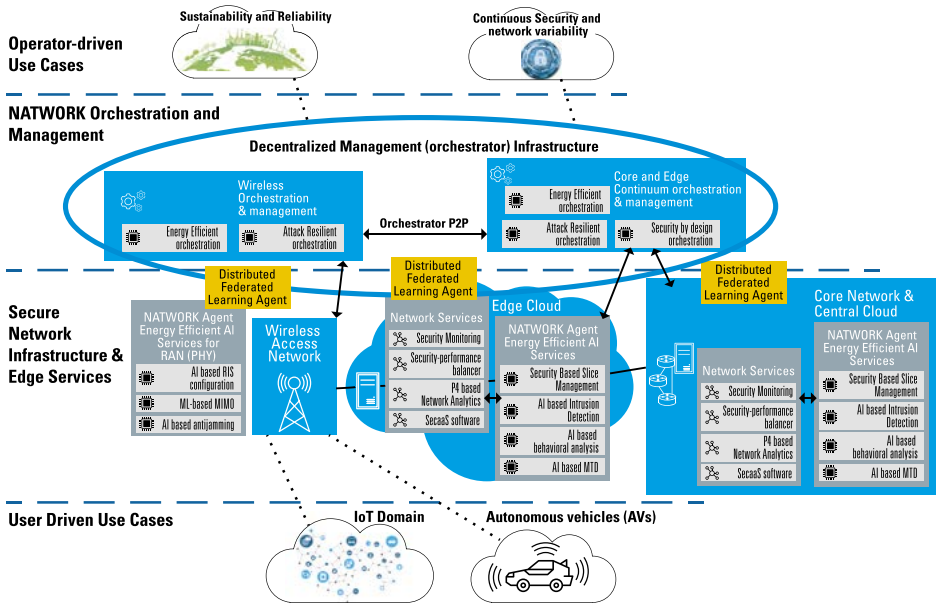

ROBUST-6G

ROBUST-6G aims to address the new concerns posed by the dynamic nature of forthcoming 6G services and networks in the future cyber-physical continuum by developing data-driven, AI/ML-based security solutions.

OVERVIEW

ROBUST-6G will investigate the security and robustness of distributed intelligence, enhancing privacy and providing transparency by leveraging explainable AI/ML, ensuring sustainability by promoting sustainable, green AI/ML methodologies to optimise the computation requirements and minimise the consumed energy while providing the necessary performance for AI/ML-driven security functionalities.

ROBUST-6G will implement automatic, zero-touch, security and resource management for trusted and certified services among multiple stakeholders in distributed dynamic scenarios.

Moreover, ROBUST-6G will utilise AI/ML-enabled smart techniques to detect and mitigate physical layer attacks on network and user devices and to propose novel physical layer security schemes for demanding scenarios (low latency, low energy consumption, and low complexity), considering new radio technologies for 6G.

CONCEPT/ARCHITECTURE

ROBUST-6G's architecture has five core elements for robust 6G network development:

Data Management Module oversees the collection of infrastructure, network, and service data, comprising Data Fabric for data processing and exposure, and Data Governance for defining access policies. It identifies

assets to be protected and assesses associated risks, ensuring controlled and secure data access.

Distributed AI-driven Security Module safeguards privacy, as well as ensures robustness, transparency, explainability, reliability, fairness, and sustainability of the AI. It consists of 1) a

ROBUST-6G High Level Architecture

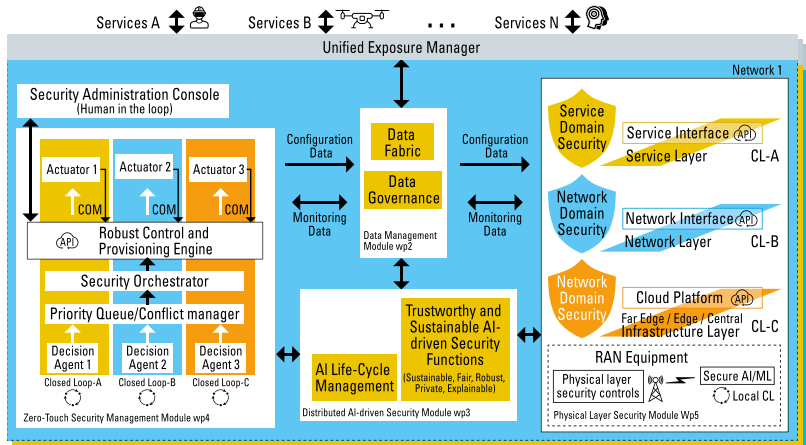



Coordinated by Güneş Kesik,
Ericsson Turkey

January 2024 – June 2026

Website: <https://robust-6g.eu/>

X: twitter.com/Robust6G

LinkedIn: www.linkedin.com/company/robust-6g/

Project Consortium Members:
Ericsson Turkey, Telefonica, University of Murcia, Chalmers University, University College of Dublin, University of Padova, Nextworks, ENSEA, Linköping University, Eurecom, Thales Six GTS, Gohm Electronics, Axon Logic



service, which performs incident detection/prediction/response, 2) Trustworthy and Sustainable AI-driven Security Functions to ensure trust in AI functionality, and 3) AI Life-Cycle Management to enable mechanisms such as training, scaling, and deployment.

Zero-Touch Security Management Module relies on closed loops to provide rapid responses to detected or expected incidents. In these loops, Decision Agents are powered by the Trustworthy and Sustainable AI-driven Security Functions component, but Decision Agents might request that the controlled solution be reconfigured. Each reconfiguration request has a priority in the queue of the Security Orchestrator that performs

the activation by the Robust Control and Provisioning Engine (RCPE) and the actuators.

The Security Administration Console offers human intervention and understanding the rationale of AI decisions through XAI capability.

The Physical Layer Security Module autonomously detects and mitigates threats using local AI agents, enables RAN equipment independently make rapid decisions. AI agents' life cycle management and updates are overseen by the Distributed AI-driven Security Module. Inferences are communicated to the Data Management Module. This module also handles RF fingerprinting migration and predicts security changes in low-power devices.

ROBUST-6G
Research Areas

AI/ML-driven security architecture	AI/ML-driven security orchestration	Adversarial ML	Scalable and sustainable AI	Privacy preserving FL for fully distributed scenarios	Privacy preservation techniques for peer-to-peer collaborative FL platforms
AI/ML Trustworthiness evaluation framework	Closed loop automation	Robust and agile resource management	DFL intrusion detection	Detection of security threats on FL system	Fair and explainable AI methodologies for threat detection and prediction
Data fabric architecture	Host-neutral data infrastructure for security orchestration	AI/ML fingerprint-driven detection of physical layer attacks		Privacy and sensing integrity and PHY anomaly detection for 6G physical layer fingerprinting	

**USE CASES/
SCENARIOS**

ROBUST-6G innovations will be demonstrated and tested through three use case scenarios.

- AI Model Trustworthiness Evaluation in 6G Distributed Scenarios:** This use case focuses on evaluating the trustworthiness of decentralised ML/DL models, examining aspects such as model robustness, sustainability, explainability, fairness, security in communications, and infrastructure trustworthiness, including physical and sensing layers. Mitigation strategies against potential attacks using Physical Layer Security (PLS) are also considered.
- Automatic Threat Detection and Mitigation in 6G-Enabled IoT Environments:** This use case

explores complex scenarios in 6G's extreme edge IoT environments, leveraging the ROBUST-6G platform or Zero-touch Security management, Data Fabric, and AI/ML for threat detection, decision-making, and mitigation.

- Security Capability Exposure via NetSecaaS:** This use case focuses on leveraging the GSMA Open Gateway framework, integrating ROBUST-6G's AI/ML-driven security (NetSecaaS) for easy application by developers and enterprises. This use case demonstrates extending Open Gateway with security APIs, supported by ROBUST-6G's Data Fabric, to offer secure, on-demand network capabilities.

**EXPECTED
RESULTS**

Expected innovations of ROBUST-6G are grouped under four main pillars:

- Trustworthy and Sustainable AI/ML for 6G Security,
- Zero-Touch Management for secure 6G systems,

- AI/ML Enabled Physical Layer Security,

- AI/ML-driven Security Architecture and Dataspace for 6G networks.



SAFE-6G

SAFE-6G pioneers a holistic research approach, situating a native trustworthiness framework atop the open and distributed USN/NSN-based 6G core, leveraging (X)AI/ML techniques to coordinate user-centric safety, security, privacy, resilience, and reliability functions, strategically optimising the Level of Trust (LoT)

OVERVIEW

The SAFE-6G project aims to evolve 6G into a user-centric system, necessitating significant architectural changes for individualised user experiences. This design will offer personalised management of data, policies, and mobility, centering network services around each user. The goal is to move from a one-size-fits-all approach to a “my network” concept, where users manage their own networks, enhancing service personalisation. User-Centric Networks (UCN) will handle mobility, policies, sessions, and data, offering reduced signal exchanges and lower latency.

The proposed 6G Beyond Service-Based Architecture (B-SBA) will enable deploying Network Service Node (NSN) components in one location and aggregating User Service Nodes (USN) in various locations, allowing for network slices tailored to user needs. This B-SBA core architecture’s evolution will reform current 3GPP interfaces and functions.

SAFE-6G expects to develop strong ties and connections with projects from all streams, in particular with all Stream B4 projects as well as Stream C projects.

CONCEPT/ARCHITECTURE

The evolving 6G network architecture, with its user-centric approach, represents a shift from previous operator-centric strategies. Addressing the limitations of monolithic entities like 4G’s MMEs and 5G’s AMFs, 6G aims to give users more control over network services, dividing the network into User Service Nodes (USN) and Network Service Nodes (NSN) for collaborative sensing and learning.

A distributed cloud continuum brings efficiency and flexibility but introduces complex security challenges. The

disaggregated nature of 6G, along with diverse hardware and software across locations, necessitates rethinking trust and security. Unlike 5G’s centralised trust connections, 6G requires a broader trustworthiness framework addressing safety, security, privacy, resilience, and reliability.

Balancing security with usability, the proposed framework focuses on security-by-design and cognitive coordination technologies, including AI and ML-driven Intent-based trustworthiness, crucial for a resilient and trustworthy 6G system.

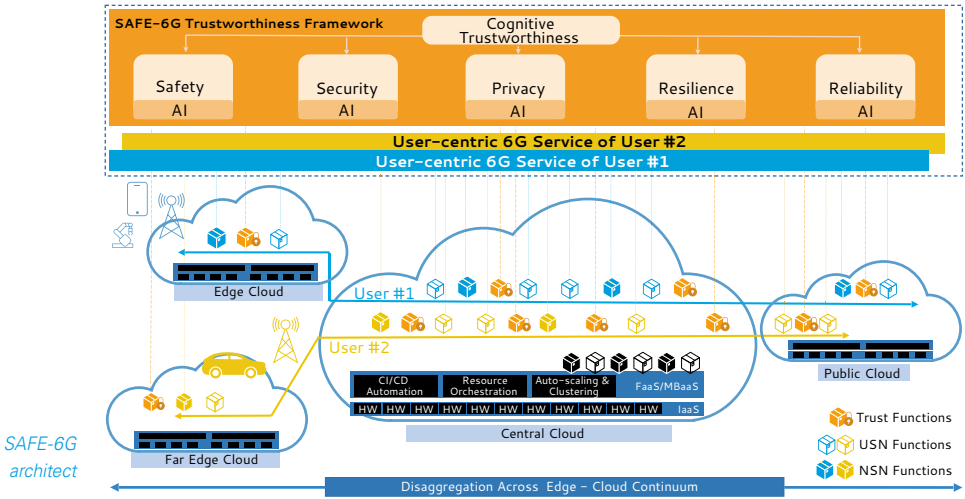

SAFE-6G architect

USE CASES/ SCENARIOS

1. Industrial Metaverse of a Production Line:

The first use case revolves around a Digital Twin (DT) of an industrial production line, utilising DTs for flexibility and optimisation in factories. In SAFE-6G, this involves XR+AI services enhancing a factory DT's use, focusing on machine and worker adaptation and rescheduling. XR components visualising workflows and AI-generated reorganisations aid decision-making and DT updates, emphasising IoT for data sharing and worker safety.

2. Metaverse for Education:

This use case explores 6G in an educational metaverse, inspired by the rise of VR/AR tech and hybrid teaching needs post-COVID-19. IMM's project creates a hybrid classroom workspace for both remote and co-located students to interact seamlessly in XR. The focus is on telepresence, collaboration, and XR+AI in Unity applications, with virtual agents aiding teachers and students for an enhanced educational experience.

EXPECTED RESULTS

1. Establish 6G trustworthiness by considering risks in a human-centric ecosystem to build a zero-touch E2E cognitive framework for user-centric 6G architectures, enabling trusted system instances with AI/ML across the edge-cloud continuum.
2. Develop and assess a cognitive coordination framework for FL-driven (X)AI, ensuring trust levels in 6G systems and optimising AI/ML models with MLOps training.
3. Create AI-assisted functions for safety, security, privacy, resilience, and reliability in a user-centric 6G ecosystem, addressing all lifecycle phases and establishing a scalable trust regime.
4. Utilise a cloud-native approach for SAFE-6G framework components and 5G/6G networks, aiming for compatibility with emerging MetaOS like aerOS for future interoperability.
5. Validate SAFE-6G using Metaverse-based pilots, testing immersive applications in varied 6G setups and service deployments, under different security scenarios, and assessing AI/ML methods.
6. Maximise SAFE-6G impact via widespread dissemination, capacity building, standardisation, and showcasing the concept to industry and regulatory stakeholders.



Smart and Adaptive Framework for Enhancing Trust in 6G Networks

Coordinated by Javier Garcia Rodrigo (Telefónica Innovación Digital) January 2024 – December 2026

Website: <https://safe-6g.eu/>

X: @SAFE6G

LinkedIn: www.linkedin.com/company/safe-6g/

Verticals concerned: Smart Cities (Education), Industry, Media & Entertainment

Project Consortium Members: Telefónica ID, National Center for Scientific Research "Demokritos", Thalès Six GTS, National Center for Scientific Research "Demokritos"; InQbit Innovations, ATOS Spain, University of West Attic, Space, Infolyxis, eBOS, Polytechnical University of Valencia, 8Bells, Cumucore, Immersion.



ELASTIC

ELASTIC targets enhancing security and efficiency in 6G network management

OVERVIEW

ELASTIC project will focus on novel approaches for 6G service orchestration, service dynamic scaling and optimisation. It will combine several novel key technologies, i.e., privacy-preserving AI, federated ML and edge orchestration, which have a strong impact on modern cloud-native ecosystems. ELASTIC aims to:

1. Analyse and enhance executable isolation for efficient, portable, secure cloud and edge computing.
2. Develop secure, flexible serverless FaaS orchestration, ensuring data authenticity in dynamic services.
3. Create a secure, private execution environment with confidential

computing for secure multi-stakeholder services.

4. Build efficient, reliable edge and IoT workload orchestration for 6G, ensuring resilience in diverse, connected environments.
5. Support 6G standardisation and tech dissemination, in line with EU capabilities for efficient, secure service deployment.

ELASTIC addresses 6G need for secure, efficient orchestration, offering flexible, serverless service deployment, service delivery optimisation, and secure data handling. It, also, focuses on addressing 6G critical security challenges.

CONCEPT/ARCHITECTURE

ELASTIC aims to develop a resource-efficient, secure, and highly distributed service orchestration and data processing framework for the 6G domain (figure), it integrates various technologies spanning the 6G architecture, from the core network to edge device. Key components of ELASTIC are:

WebAssembly (Wasm) improves the efficiency and security of cloud orchestration.

Function-as-a-Service (FaaS) is a promising computing framework

that can be leveraged to execute low-latency, high-throughput applications, making it suitable for emerging IoT and edge computing use cases.

Confidential Computing is a novel technology which can provide a strong level of assurance of data integrity, confidentiality, and code integrity.

eBPF/XDP is a framework that combines an extended version of the Berkeley Packet Filter (BPF) with the eXpress Data Path (XDP), delivering high-speed packet processing performance.

USE CASES/SCENARIOS

The ELASTIC solution will be validated and assessed in real-life demonstrations.

The first use case introduces an IoT data fabric solution for hyperscale data processing in a 6G infrastructure. It will evaluate the portability,

usability, and security of different ELASTIC processing technologies on a control and monitoring simulation of four factories simultaneously. The demonstrator will use static analysis algorithms to identify security vulnerabilities, utilising the ELASTIC

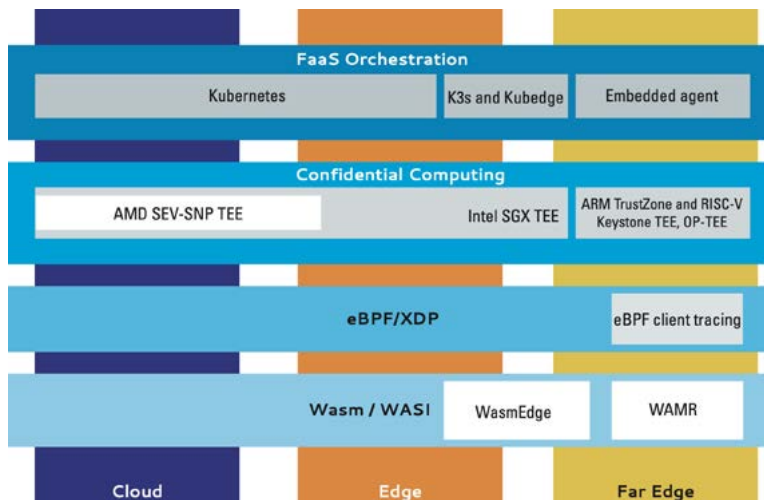

framework for efficient detection through cross-platform AI solutions.

The second use case will focus on confidential computing for private data centres. It will leverage confidential computing HW-based platform

abstractions and remote attestation to provide easy mapping of VMs in an automated and platform-independent manner. Additionally, it will advance the efficient, portable and secure edge workload of the ELASTIC orchestration for low latency.

EXPECTED RESULTS

6G promises a major advancement in network services, delivering ultra-high data rates, ultra-low latency, ultra-reliability, and energy efficiency. In order to fully realise the benefits of 6G, it is crucial to ensure efficient and effective orchestration of a broad range of services and resources.

ELASTIC will concentrate on orchestrating 6G extensive array of services and resources, focusing on developing new orchestration mechanisms for cluster-based environments, characterised by efficiency, simplicity, reliability, development support, and security.

*Efficient, portable
And Secure orchesTration
for reliable servICes*



Coordinated by Sotiris Ioannidis,
Technical University of Crete
January 2024 – December 2026

Website: <https://elastic-project.eu/>

X: twitter.com/ElasticProject

LinkedIn: www.linkedin.com/company/elastic-project

Project Consortium Members:
Technical University of Crete, Ericsson, LM
Ericsson, Telefonica ID, Thales Six,
Thales DIS, IMEC, Ultraviolet Consult,
Aalto University,
Lund University,
Abstract Machines,
Zentrix Lab,
Polytechnical
University of Turin.



Stream B5

MICROELECTRONICS-BASED SOLUTIONS FOR 6G NETWORKS

Call#2 B5 projects will contribute to the strong push towards the advancement of European microelectronics in providing solutions for next-generation communication networks and devices at various levels of the device data processing chain, from baseband and mixed-signal processing to RF and antenna systems covering frequencies from sub-6 GHz to THz.

6G-REFERENCE

6G-REFERENCE targets transceiver hardware innovations enabling 6G densely distributed systems exploiting Distributed MIMO (D-MIMO).

OVERVIEW

To allow for flexible deployment, fibre access cannot be taken for granted. Synchronisation in frequency and time over the air then becomes a key challenge. Moreover, improvements in data capacity are wanted, while also supporting distributed sensing functionality. Realising all this functionality in practical hardware with low complexity, cost, and power consumption is a key challenge. We believe this may be possible exploiting the cm-wave 10–15GHz spectrum. Hence this project has 5 goals: i) transceiver cm-wave Radio Frequency hardware innovations to address the data capacity and scheduling challenge of D-MIMO. ii) Novel solutions for accurate over the air frequency, phase and time synchronisation. This would not only support high-capacity data rate communication, but may also enable high-resolution UTC distribution and accurate positioning and sensing. iii) New RF and antenna components providing extended spatial and frequency domain selective capabilities at reduced complexity, cost, and energy consumption. iv) Hardware solutions

with low complexity, low cost, and low power consumption. v) Coexistence with existing services in the 10–15GHz range, which is targeted since it not only provides new spectrum opportunities but also efficiently balances the benefits and drawbacks of sub-6GHz and mm-wave solutions.

Remarkably, our vision of 6G based on distributed systems with integrated sensing and communication capabilities is shared with 5 out of the 6 projects in SNS Phase 2 Stream B-01-02 (6G-DISAC, iSEE-6G, INSTINCT, 6G-SENSES, 6G-MUSICAL). 6G-REFERENCE outcomes to those projects could be in the form of hardware designs solving key system aspects such as full-duplex operation or time/frequency synchronisation of distributed nodes, whereas 6G-REFERENCE may leverage on the results of these projects on system/device requirements from the signal processing point of view. A rather unique feature of 6G-REFERENCE is the focus on Frequency Range 3 (FR3), which already received a strong industrial interest including a study item in 3GPP.

USE CASES/ SCENARIOS

In urban areas, 6G will need to rely on a sustainable solution to cope with the ever-increasing traffic demands and population densification, while providing disruptive capabilities like the materialisation of the internet of sense. The solution envisioned by 6G-REFERENCE consists of ultra-dense cell-free deployments for joint coherent communications and sensing at cm-waves, which balance the benefits of sub-6GHz (e.g. reduced pathloss) and mm-wave (e.g. wide

bandwidth) ranges. These systems face five fundamental challenges: i) the need of accurate synchronisation among distributed radio units; ii) fronthaul data distribution; iii) integration of sensing capabilities; iv) low complexity/cost/consumption radios; and v) coexistence with other services. 6G-REFERENCE will develop integrated circuit and antenna component solutions addressing all of them. Frequency/time synchronisation circuits will leverage recent innovations and explore new

architectures with faster synchronisation. Efficient full duplex fronthaul data distribution among cascaded radio units will be explored, while also enabling integrated monostatic radar sensing. Besides these, on the sensing domain, 6G-REFERENCE will explore environmental sensors integrated in the antenna estate, reuse the synchronisation framework for accurate

localisation, and develop new array solutions building on recent innovations in modulated arrays. Finally, dynamic IF and antenna filtering will be explored to enable efficient spectrum coexistence schemes. The ultimate goal of 6G-REFERENCE is to develop hardware enablers that could end up constituting a reference design for future 6G distributed radios.

CONCEPT/ARCHITECTURE

Simplified example of a Distributed MIMO system with only one cabled 6G-network node providing data and an accurate time and frequency reference. RUs/APs cooperate to realise Over-the-Air Synchronisation (OAS) via Full-Duplex Sync timeTx and timeRx signals (green) and data distribution/gathering (blue arrows).

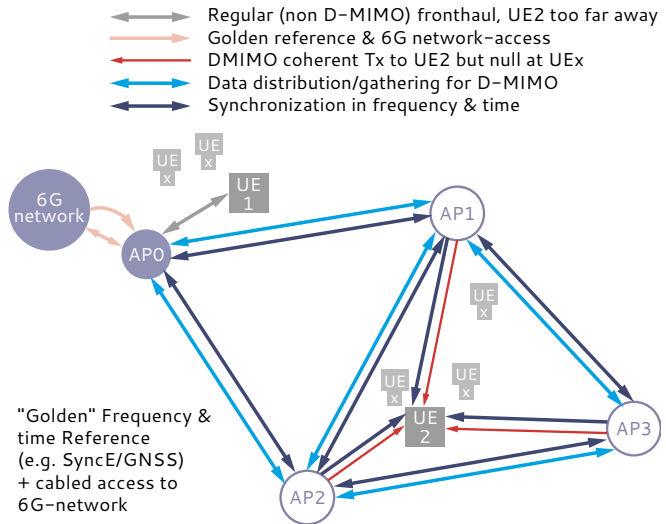

EXPECTED RESULTS

6G-REFERENCE will contribute to the European leadership in micro-electronic solutions for communication infrastructure by developing hardware enablers for densified cell-free deployments targeting not only coherent data transmissions but also high accuracy localisation and sensing, thus materialising the connection between physical, digital and human worlds. The green transition in 6G-REFERENCE will rely on densified deployments of low energy distributed nodes capable of providing at the same time enhanced multiuser beamforming schemes for data transmission and accurate sensing. Enabling a densified deployment of distributed radio units, 6G-REFERENCE will contribute to improve the availability in high density populated areas, ensuring coverage from multiple radio units in every corner. Moreover, it will be achieved in a sustainable manner,

from the energy point of view. In addition, we will also directly contribute to UN SDG 13 on climate actions, by developed environmental sensors in antenna system hardware in order to realise virtual environmental quality maps. 6G-REFERENCE will not directly address new business models but will indirectly enable their conception, specially by integrating communications with localisation and passive radar sensing, which may definitely boost the creation of new applications and businesses. The ultimate goal of 6G-REFERENCE is to ensure the commercial feasibility of the developed hardware solutions not only by aligning them with current standardisation activities and goals, but also by facilitating that the standardisation work can be based on the correct knowledge of the capabilities and limitations of the developed hardware.



**6G haRdware
Enablers For cEll
fRee cohEreNt
Communications
& sEnsing**

Coordinated by Ignacio Llamas-Garro, Centre Tecnologic de Telecomunicacions de Catalunya
January 2021 - December 2026

Website: <http://6greference.eu>

X: @6G_Reference

LinkedIn: 6G-Reference

Verticals concerned:

Automotive, Public Safety

Project Consortium Members:
CTTC, Ericsson, University of Twente, CEA, Anteral, MTU Australo Alpha Lab, IMEC, Polytechnical university of Zurich, Advanced Circuit Pursuit AG, University of Birmingham.



FirstTo6G

FirstTo6G brings together European SMEs, universities, and consultancy to create a revolutionary 6G transceiver microchip technology.

OVERVIEW

FirstTo6G brings together European SMEs leading universities and a Swiss consultancy to develop the world's first 6G transceiver microchip technology, i.e. data converters and corresponding sub-THz front-ends, that fulfil the extreme requirements to make 6G a widespread reality. These requirements include an extremely wide modulation bandwidth with high signal quality, high energy efficiency, and low cost.

Using a novel breakthrough microchip architecture, data converters with up to 16 GHz of modulation bandwidth, with extremely low power consumption, which are implemented in a commercial, low-cost 22 nm semiconductor technology, will be developed. A state-of-the-art frontend technology will also be developed, and both parts will

be integrated into two full transceiver chipset solutions with unprecedented capabilities.

Within the SNS programme this project addresses key long term technological challenges related to the global introduction of 6G systems by 2030.

By demonstrating what is technically possible, the results of this project have the potential to make a significant contribution to the 6G standardisation process and can therefore be used by other SNS projects who work on standardisation topics.

And importantly, the chipset technology developed in this project can be used in experimental radio devices for 6G infrastructure projects.

CONCEPT/ ARCHITECTURE

The FirstTo6G project focuses on developing TRx solutions for 6G communications, specifically targeting the V-band and D-band frequencies. This initiative is crucial for enabling faster mobile networks in the future. The figure shows the block diagram of the anticipated systems as well as the contributors among the consortium.

At its core, the project's architecture involves integrating Fourier Domain Digital-to-Analog and Analog-to-Digital Converters (FDDACs/FDADCs) with new frontend technologies. Hereby, the innovative FDDAC and FDADC approaches allow the integration of highly capable data converters on a 22 nm FDSOI technology. This integration is key

to achieving the required modulation bandwidths for high-speed data transmission in FDSOI technology in the most energy efficient way. The proposed V-Band solution targets to implement the complete transceiver chain achieving a total modulation bandwidth of 8 GHz in a modern CMOS technology. The proposed D-Band solution introduces 16 GHz data-converters implemented in 22 nm FDSOI and a front-end developed in III-V semiconductor technologies.

Technological innovations in FirstTo6G focus on enhancing energy efficiency and cost-effectiveness, addressing some of the most significant challenges in chipset development for 6G.

Proposed transceiver block diagrams for the V-Band solution (above) and the D-band solution (below).

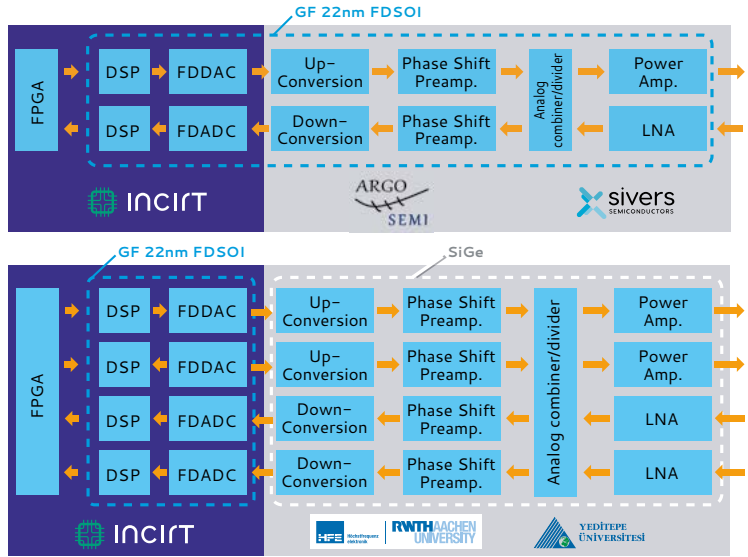

USE CASES/ SCENARIOS

The past has shown that new wireless communication standards enable completely new or much improved use cases and 6G will not be different.

With up to two magnitudes higher data rates, 6G will enable live-like resolution communication where the

borders between the real and virtual world disappear.

With 6G, devices will have high resolution sensing capabilities which will revolutionise virtual reality application and enable completely new modes of interaction between humans and devices / machines / robots.

EXPECTED RESULTS

FirstTo6G will generate critical connectivity 6G chipset technology, which will overcome key technical barriers in terms of modulation bandwidth, energy efficiency and chipset cost. This technology will help to enable the widespread establishment of 6G networks.

In particular, the project will deliver two demonstrators for 8 GHz and 16 GHz modulation bandwidth systems for above and below 100 GHz

frequency. It will additionally yield novel automated circuit design software for front-end chips.

The widespread availability of 6G networks will enable economic growth, increased productivity and therefore increased wealth and prosperity of society. It will further strengthen the European high-tech communication microelectronics ecosystem improving European technological sovereignty, independence, and security.

Fourier-Domain TRx solutions enabling widespread realisation of 6G



Coordinated by Sebastian Waters, InCirt
January 2024 – June 2027

Website: <https://www.firstto6g.eu>

LinkedIn: <https://www.linkedin.com/company/firstto6g>

Project Consortium Members:
InCirt, Sivers Wireless, Argo Semiconductors, Yeditepe University, RWTH Aachen University, SCIPROM.



TERAGREEN

Towards Energy-Efficient High-Speed Wireless Links

OVERVIEW

The exponential demand on global wireless data streaming services is pushing current communication network technologies to their limits. To respond to this demand, future 6G networks will depend on Tbit/sec data rate transmission via easily deployable and energy-efficient wireless links. Current 5G wireless systems, characterised by their small spectral bandwidths and high-power electronics are fundamentally limited in terms of achievable data rates vs energy consumption.

The TeraGreen goal to enable energy efficient wireless links with Tbit/sec capacities in the THz frequency domain. It achieves a better usage of both spectrum and hardware resources, and

hence reduce the associated carbon footprint of production of electronics when compared to current 5G and 6G solutions. TeraGreen is expected to reduce the power consumption in future 6G base stations by a factor of at least 1000 in terms of energy per bit, while increasing the aggregated data rates by a factor of at least 10.

TeraGreen will establish the foundations for future Tbit/sec communications systems by providing the understanding and proof-of-concept demonstrations of how the generation, detection and multiplexing of multiple ultra-wideband THz signals can be realised with highly energy-efficient and scalable technological solutions.

TECHNOLOGICAL INNOVATIONS

TeraGreen is composed of a multi-disciplinary team assembled to deliver integrated THz transmitter and receivers for Tbps wireless point-to-point links with all the essential RF-hardware development capabilities to exploit the 252–325GHz band. In particular, the focus is on the:

- Development of THz transceivers with a new silicon technology reaching 500GHz cut-off frequencies to address the lack of commercial THz technology bottleneck.
- Development of quasi-optical antennas with ultra-high gain and alignment capabilities to address the high free space spreading loss bottleneck.

- Development of multi-beam lens arrays to reach spatial multiplexing enabling, for the first time, a path to achieve Tbps links.
- Development of wideband waveforms suitable for energy-efficient 1-bit A/D conversion with temporal oversampling for the exploitation of 100GHz bandwidth to address the A/D conversion power efficiency bottleneck

TeraGreen concept: quasi-optical MIMO antenna for the formation of multiple near-field communication spatial channels. Each channel transmits a 70GHz signal with zero-crossing modulated waveforms. The QO antenna is based on lens arrays integrated with dual-polarised wideband SiGe-BiCMOS transceivers operating at 300GHz and integrated with advanced MMIC package technology.

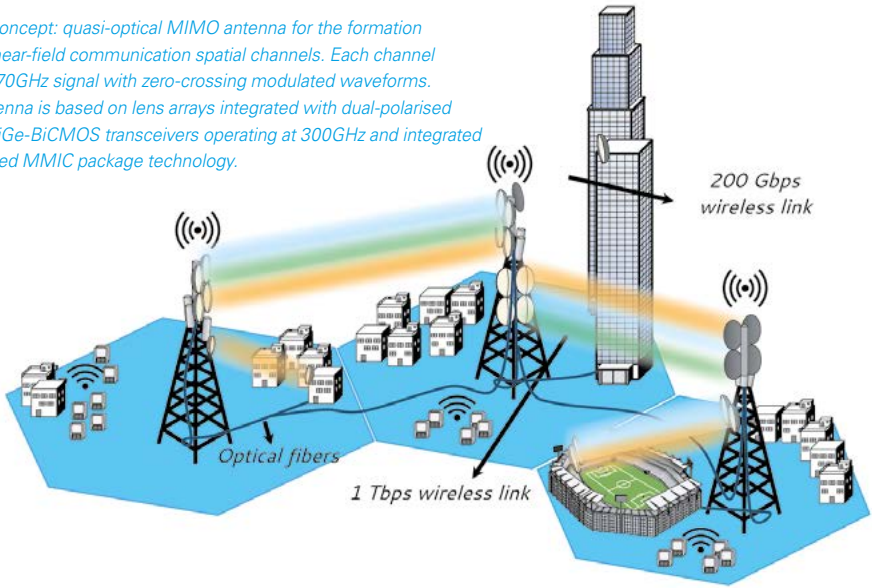

USE CASES/ SCENARIOS

The success of TeraGreen will bring significant advances in the evolution of communications networks in 6G. It can serve as a complete back-haul solution for small-cell dense urban networks and for purpose-built fixed wireless access applications where back-haul capacity is in the range of 200-1000 Gbps. In particular, the back-haul technology of TeraGreen can be used as an alternative to the wired, fibre or microwave back-haul

link of dense cells and microcells. In this way, TeraGreen will enable the densification of cells in a cost-effective manner, since it will downscale the need to deploy wired back-haul links (i.e. only to those small-cell base stations that do not have a LoS). Thanks to the energy efficiency of the proposed technologies, this densification will also be possible in a power-friendly and eco-friendly manner.

IMPACT

TeraGreen will provide key technologies for a long-term impact on RAN evolution making it more energy-efficient, more flexible, and scalable than present deployments. Moreover, the project outcomes support EU suppliers in communication and computing markets to be competitive in the global market by offering solutions reaching a forefront level in terms of capacity, cost-, spectrum- and energy-efficiency.

TeraGreen will develop two link demonstrations that will define two essential KPIs at the system level (capacity and energy):

- An experimental demonstration of a medium range link will be done to show the potential of the TeraGreen technology with a record demonstration of 200 Gbit/sec energy-efficient wireless transmission (>8.000Tbit/Joule). The scope is to demonstrate higher data rates and energy per bit and orders of magnitude better performance than previous silicon technology-based demonstrations.
- A proof-of-concept in a laboratory environment of a multi-mode near-field link propagation of a wireless links achieving Tbit/sec and radiated energy efficiency (>40.000Tbit/Joule).

*Towards Energy-Efficient
Tbps Wireless Links*

TeraGreen

Coordinated by Marta Kluba,
Delft University of Technology
January 2024 - December 2026

Website: [TeraGreen.eu](https://www.teragreen.eu)

LinkedIn: [https://www.linkedin.com/
company/teragreen](https://www.linkedin.com/company/teragreen)

Project Consortium Members:
Delft University of Technology, Chalmers
University of Technology, INFINEON
TECHNOLOGIES,
Ericsson, Dresden
University
of Technology,
OTE



Stream B6

EU-US 6G R&I COOPERATION : 6G-XCEL

The aim of 6G-XCEL is to seamlessly integrate AI to enhance the capabilities of the 6G network, while also ensuring the collaboration between EU and US stakeholders is concrete and productive.

6G-XCEL

The 6G-XCEL project aims to integrate AI into the development of 6G networks, focusing on decentralised AI controls in edge network use cases.

OVERVIEW

Artificial intelligence (AI) is extensively studied and is increasingly being adopted across communication technologies that span network layers and business ecosystems. It is expected to play a pivotal role in both the design and operation of future sixth-generation (6G) networks, influencing not just the networks themselves but also the broad range of AI-driven user applications.

The 6G-XCEL project aims to conduct research on edge network use cases involving decentralised, multi-party AI controls executed over edge compute accelerators. These controls are designed to coordinate activities across both radio and optical networks. A critical component of this research is the development of a reference framework for AI in 6G, which will facilitate global validation, adoption, and standardisation of AI methodologies. This framework is set to allow the federation of AI-based network controls across various network domains and physical layers, promoting both security and

sustainable practices. Research into the resultant decentralised multi-party, multi-network AI (DMMAI) framework will support the creation of reference use cases, data acquisition and generation methods, and repositories for data and models. This also includes curated training and evaluation datasets, as well as technologies and functionalities for benchmarking future AI/ML solutions in 6G networks.

Importantly, the 6G-XCEL project will unite a broad ecosystem of researchers from the EU and US to integrate elements of the DMMAI framework into their respective testbeds and laboratories, thereby embedding it into their research agendas and validating the framework across diverse platforms.

By collaborating openly across continents and in close association with standardisation groups within each jurisdiction, 6G-XCEL is set to achieve joint EU-US advancements in the large-scale application of AI within 6G networks.

Ecosystem of researchers from the EU and US



CONCEPT/ ARCHITECTURE

The 6G-XCEL project will provide a framework and tools for research and development of decentralised AI methods for network control extending across radio and optical networks and network domains, which we refer to as a 'multi-network' approach. In particular, we will build on the O-RAN architecture as an open platform supporting multi-party applications (xA-ppls/rApps) in a Radio Access Network Intelligent Controller (RIC). Our focus is to study the practical use of such controls and their potential for 6G networks. We will enhance the O-RAN architecture, extending its capabilities

from the RAN into the optical domain, to introduce AI-driven control functionalities across the entire network spectrum. The project will focus on benchmarking functionality across the different testbeds in the EU and US. It will provide initial studies on the DMMAI framework in relation to important research challenges. These challenges include energy efficiency, AI control loop time scales, efficient and scalable management of large-scale time series data, security and privacy mechanisms in multi-party situations, and integration with different AI orchestration platforms.

USE CASE/ SCENARIOS

To study the DMMAI framework, 6G-XCEL will conduct several pilot experiments and measurement campaigns

on two broad use cases: dynamic spectrum access and AI enhanced resource management for energy efficiency.

EXPECTED RESULTS

The 6G-XCEL framework will comprise network functions, design rules, and requirements for DMMAI control scenarios, designed to be implementation agnostic. Multiple reference implementations will be developed and benchmarked across the project's testbeds. Datasets, measurement

methodologies, and results from use cases will be available for further study and standards development. Testbed implementations will offer open access for research. A key outcome is establishing a transatlantic research community on networks & AI, laying a foundation for 6G.

6G Trans-Continental Edge Learning



Coordinated by Daniel Kilper,
Trinity College Dublin

January 2024 - December 2026

Website: www.6g-xcel.eu

X: twitter.com/6GXcel

LinkedIn: [www.linkedin.com/
company/6g-xcel/about/](https://www.linkedin.com/company/6g-xcel/about/)

Verticals concerned: All

Project Consortium Members:
Trinity College Dublin, Deutsche Telekom,
Dienekes, HHI Berlin, IBM, IMEC, Juniper,
Sorbonne University, University of Aalborg,
University of Patras.



Stream C

COMPLEMENTARY SNS EXPERIMENTAL PAN-EU FEDERATED INFRASTRUCTURE: SUNRISE-6G

The stream C focuses on SNS system Enablers and PoCs with a target to further develop and consolidate Europe wide experimental infrastructure(s), in support of the various phases of the SNS. Federation of EU platforms is also targeted with capabilities to extend to non SNS test platforms, either at national level or with third countries.

SUNRISE-6G is the SNS call#2 flagship project in this field.

SUNRISE-6G

SUNRISE-6G aims to develop an open, scalable approach for experimenting and deploying vertical applications within a Europe-wide 6G infrastructure network.

OVERVIEW

SUNRISE-6G is the one funded project in the SNS Stream-C-01-01 call, addressing the federation of existing 6G experimentation platforms from all Stream C Phase-1 projects (6G-BRICKS, 6G-SANDBOX, 6G-XR). Other SNS Phase 1 projects (e.g., ADROIT-6G), national projects (e.g., 6G-RIC) and the pan-European federation project SLICES-RI. SUNRISE-6G proposes a scalable,

open and standards-compliant approach to experimentation and vertical application deployment in a pan-European Federation of 6G infrastructures, that provides access to a comprehensive library of 6G enablers. This approach, leveraging and extending APIs from the Camara Initiative and GSMA OPG, provides a clear roadmap to 3GPP compliance and future Stream-D deployment

CONCEPT/ARCHITECTURE

The SUNRISE-6G experimentation facility architecture aims to deliver a truly scalable federation architecture that provides to vertical application developers and experimenters access to heterogeneous computing resources and devices from all Europe as a cohesive and abstracted continuum. This is achieved without a centralised Orchestrator or Resource Manager, as has been attempted in previous research initiatives, but fully leveraging intelligent, decentralised paradigms

and emerging application portability and federation standards from the CAMARA initiative and the GSMA OPG.

The project execution will be based on 4 innovative pillars:

- The Implementation of New 6G Enablers (Near-Field RIS & JCAS enablers, Dual connectivity for NTN-terrestrial access, and an O-RAN DT)
- A Truly Scalable and 3GPP Compliant Federation Solution

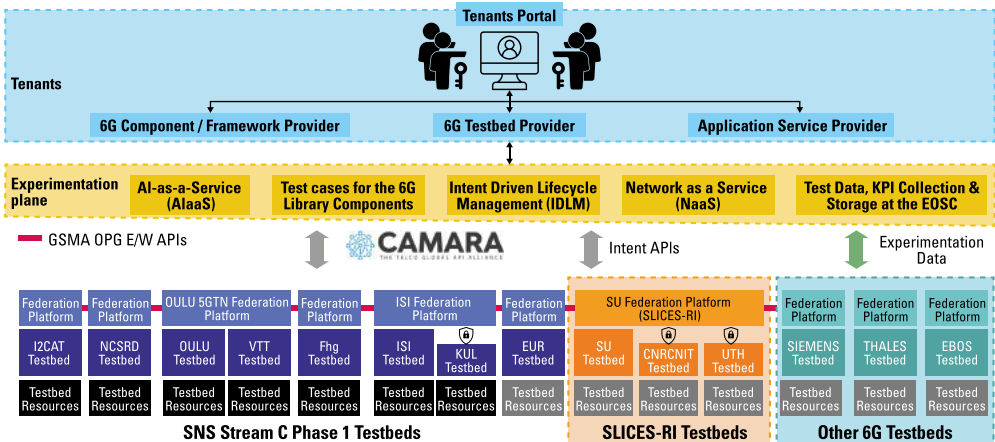

- A Federated AI Plane Promoting a collaborative, MLOPS driven approach to AI research
- A Commonly Adopted Experimentation Plane supporting a groundbreaking experimentation technique based on natural language prompting

USE CASES/ SCENARIOS

The project identified three use cases that will be used to showcase the envisioned innovations and federation architecture.

The first use-case is “Cross-domain Metaverse”. It has the objective of validating the Federation Framework, addressing the deployment of a Realistic multi-user holographic communication platform in a cross-domain scenario

The second use-case is “Collaborative Robots for Mining”. It has the objective of validating the AI model federation and automated model distillation / finetuning techniques,

via the E2EAI MLOPS framework, applied on mining autonomous vehicles that execute inspection missions of a mining infrastructure

The Third use-case is “Federated, Dual-Connectivity NTN”. Use case testing will involve 1) mobility scenarios regarding operational reliability, resilience, and efficiency with multiple static and mobile heterogeneous compute nodes in the federated NTN system (PoC1), 2) use of NTN emulator on two radio access networks and scenarios testing multi-connectivity and in inter-PLMN handover scenarios (PoC2).

EXPECTED RESULTS

SUNRISE-6G aims at delivering a sustainable experimentation playground extending beyond the completion of the project, complemented by a rich 6G library of enablers, devices and frameworks and a decentralised intent-driven experimentation framework, for simplifying the onboarding of testbeds and applications and enabling the comprehensive testing and validation of next generation of applications towards real life 6G networks in the long term. The SUNRISE-6G consortium endorses the idea to advance further the telco industries from the classic

value chain model to a more sustainable one, through the employment of its open-source components that promote new business models (e.g., Network Infrastructure as a Service). The project will also impact the telco business via a comprehensive standardisation plan, and via fostering the creation a sustainable community of SMEs and institutions that participate in the future 6G “Network of Networks”, both collaborating and/or competing, whilst creating value for customers and end-users.

Sustainable federation of Research Infrastructures for Scaling-up Experimentation in 6G



Coordinated by
Christos Verikoukis, ISI/ATH

January 2024 – December 2026

Website: <https://sunrise6g.eu/>

X: twitter.com/Sunrise6G

LinkedIn: www.linkedin.com/company/sunrise6g/

Verticals concerned :

Media and Entertainment, Industry

Project Consortium Members:

National Center for Scientific Research “Demokritos”, Iquadrat, Siemens, Thalès, IBM Ireland, Intracom, Juniper Networks, University of Oulu, Catholic University of Leuven Networked Systems, EURECOM, Fraunhofer Fokus, I2cat, Greenerwave, Infolytis, FOGUS Innovations and Services, Sorbonne University, the National Research Council Italy, University of Thessaly, OTE, eBOS, NH APPART, Luleå University of Technology, Lenovo, Altice Labs, CNIT, Is-Wireless, VTT.



Stream D

LARGE SCALE TRIALS AND PILOTS WITH VERTICALS-FOCUSED TOPIC

The stream D targets large-scale SNS Trials and Pilots with Verticals, including the required infrastructure. Projects are expected to explore and demonstrate technologies and advanced applications and services for the vertical domains focusing on two priorities less covered in the previous call, namely i) automotive and ii) Health, Smart Cities, Farming or Education.

6G-PATH

6G-PATH focuses on developing innovative infrastructures, delivering and refining an experimentation platform, expanding user communities, and shaping the future of 6G through research and standardisation efforts.

OVERVIEW

With 5G now mature and globally deployed, the focus shifts towards advancing 6G. The 6G-PATH project aims to enhance performance and offerings by integrating new tools and products from EU companies into 5G/6G technologies. This includes measuring key performance indicators (KPIs) and value items (KVI) across 7 testbeds and 10 use cases (UCs) in 4 vertical sectors like Smart Cities, Health, Education, and Farming. A significant part of the budget will support integrating new pilot sites and technologies through open calls, aiming to incorporate 2 extra testbeds and 30 more use cases.

6G-PATH's objectives include establishing experimental and validation infrastructures, delivery and refining of an experimentation platform, expanding user communities through large-scale field trials, collecting and refinement of requirements, developing business models towards commercialisation and exploitation of the proposed UCs and technologies, disseminating results and influencing standardisation, and creating open knowledge repositories.

Comprising 26 entities from 13 countries, 6G-PATH collaborates with other SNS projects in a feedback loop, deploying and testing innovations across use cases and sharing results to advance 6G development in the EU.

CONCEPT/ ARCHITECTURE/ INNOVATIONS

6G-PATH aims to develop a dedicated B5G/6G architecture, providing a unified interaction point for use case partners. This platform abstracts lower-level operations using middleware and backend tools, allowing configuration, scheduling, and execution of pilots and experiments. It facilitates effective collection and visualisation of KPIs and KVI, offering various network applications for performance analysis.

Key innovations in 6G-PATH infrastructures include native AI-driven networks for intelligent network management, deterministic and high-resolution localisation services, Non-Terrestrial Networks (NTNs), Time Sensitive Networks (TSNs) and a time-sensitive IoT-Edge-Cloud Continuum, next-gen core, back-hauling and micro-networks, extreme end-to-end slicing and resource isolation, de-biasing of metadata, and energy-efficient management platforms.

USE CASES/ SCENARIOS

As B5G and 6G networks evolve, significant impacts are anticipated across various industries, bringing innovations like immersive virtual/augmented reality experiences, autonomous vehicle control, and large-scale IoT networks. In 6G-PATH, four key verticals with ten use cases are initially set for testing and feedback on technical innovations:

- 1. Smart Cities:** Includes three use cases focused on connected cities, automated logistics, and security. It aims to test large-scale IoT-Edge-Cloud scenarios.
- 2. Health:** Comprises two use cases (3D hydrogel patches and elderly

monitoring) exploring micro and nomadic edge nodes and networks, reliable and secure connection Over-The-Top 5G MNO and NTN integration, and XR with high bandwidth and low latency.

- 3. Education:** Features three use cases dedicated to XR and holographic-based education/training in rural schools and advanced classrooms.
- 4. Farming:** Consists of two use cases evaluating off-grid and interconnected deployments, network slicing for various QoS, and AI-driven Edge-Cloud computing for water conservation and smart vineyards.

EXPECTED RESULTS

SNS projects are set to offer a wealth of insights and technologies for B5G/6G development in the coming years. Building on this, 6G-PATH aims to foster B5G/6G growth by providing an extensive, innovative experimentation platform. This project will establish a comprehensive infrastructure, merging core architectures with domain-specific capabilities that will be made available to third parties to test, evaluate and validate applications and relevant UCs. 6G-PATH will integrate

applications and use cases across four key verticals for large-scale pilots and trials. The outcomes of these activities will be analysed to derive lessons for future 6G communications, identify and refine cutting-edge business models for commercialising 6G use cases and technologies, and potentially attract SMEs, vertical industries, and broader market stakeholders to use developed facilities and further extend innovation.



6G-Path

*6G Pilots
and TriAls
Through
Europe*

Coordinated by Ioannis Chochliouros, OTE

January 2024 – December 2026

Website: <https://6gpath.eu>

X: twitter.com/6gpath

LinkedIn: [www.linkedin.com/
company/6g-path](https://www.linkedin.com/company/6g-path)

Verticals concerned:

Smart Cities, Education, Health, Farming

Project Consortium Members:

OTE, Telefonica ID, Orange Romania, Airbus DS SLC, Hewlett-Packard Italy, University of Malaga, Karlstad University, Charité – University Hospital of Berlin, University of the West of Scotland, University of Bradford, Altice Labs, Fraunhofer FOKUS, Instituto de Telecomunicações, ICT-Ficial, OneSource Consultoria Informática, RedZinc Services, Odin Solutions, eBOS, Apart AE, F6S Network Ireland, Fundatia Orange Romania, MCS Data Labs, ACTA, Terraviv, CloudSigma, Agencia Estatal Consejo Superior de Investigaciones Cientificas CSIC.



ENVELOPE

ENVELOPE aims to advance and open up a reference 5G advanced architecture and transform it into a vertical-oriented one.

OVERVIEW

ENVELOPE is a new Horizon Europe project coordinated by the I-SENSE Group of ICCS. With a total budget of 15.8€ and a duration of 3 years, it is among the 27 new research, innovation and trials projects financed by the SNS JU.

ENVELOPE aims to advance and open up a reference 5G advanced architecture and transform it into a vertical-oriented one. It will deliver 3 large-scale B5G trials in Italy, the Netherlands and Greece supporting novel vertical services, with advanced exposure capabilities and new functionalities tailored to the services' needs. Although focused on the Connected and Automation Mobility (CAM) vertical, the developments resulting from the use cases will be reusable by any vertical. The ENVELOPE architecture will serve as an envelope that can cover, accommodate and

support any type of vertical services. The applicability of ENVELOPE will be demonstrated and validated via the project CAM Use Cases and via several open call winners that will have the opportunity to conduct funded research and test their innovative solutions over ENVELOPE. It builds on the success of previous CAM-related and SNS projects, namely 6G-BRICKS, 6G-SANDBOX and FIDAL.

ENVELOPE consists of 23 partners from 10 different EU Member States. The consortium counts on major research organisations actively involved in national and EU 5G PPP, SNS JU and CCAM partnership projects network operators with deployed 5G SA, OEMs/Vehicle providers, ICT and CAM industrial suppliers, highly expertised SMEs, a city council and a CAM-related stakeholders' partnership.

CONCEPT/ ARCHITECTURE

ENVELOPE proposes a novel open and easy-to-use architecture to enable a tighter integration of the network and service information domains (see figure). The ENVELOPE APIs act as an intermediate abstraction layer that translates the complicated 5GS interfaces and services into easy to consume services accessible by the vertical domain. The main innovative

technologies developed by the project will be: Multi-access Edge Computing (MEC) with service continuity support, zero-touch management, multi-connectivity and predictive QoS. Those will be first deployed and tested locally in lab environments and then UC validation will be performed via large scale trials in Italy, the Netherlands and Greece.

USE CASES/ SCENARIOS

The trials in the [Italian site](#) will be focusing on how advanced 5GS architectures can support dynamic reconfiguration in cases of emergency triggers. The network shall be acting as a distributed black box that will be able to collect and reconstruct an

accident scene, or even proactively detect it and provide critical guidance to avoid it. A main deployment scenario will be that of east/west-bound interfaces especially across different edge providers or MNOs.

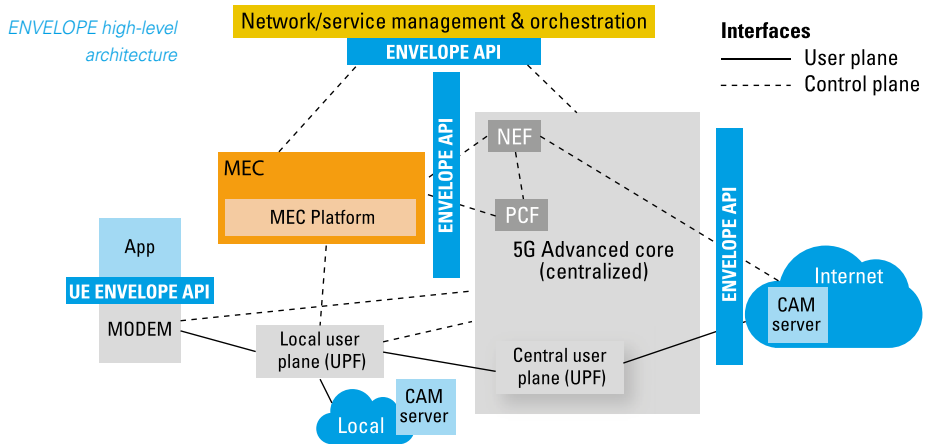

- Italian Site UC 1 “Advanced in-service reporting for automated driving vehicles”
- Italian Site UC 2: “Dynamic collaborative mapping for automated driving”
- Dutch Site UC 1 “Periodic vehicle data collection for improving digital twin, e.g., for predictive maintenance”
- Dutch Site UC 2 “Vehicle testing with mixed reality”
- Dutch Site UC 3 “Tele-operated driving aided by DT”

The focus of the **Dutch site** trials will be on the development and testing of new open APIs to support the uplink data traffic for the efficient data collection and creation of a Digital Twin (DT) running at the server/edge side. The Dutch site is based on the commercial SA network hosting a DT service running on a Multi-Access Edge service environment.

Finally, the trials of the **Greek site** will be focusing on vertical control and information delivery to the network/vehicle and the interaction of the commercial network with a private PLMN.

- Greek site UC 1 “MEC handover between multiple MNOs”

EXPECTED RESULTS

Overall, ENVELOPE will deliver an open platform for B5G experimentation as a service with support of dynamic reconfiguration. It will also contribute

to 6G development through its novel capabilities to support vertical UCs with specific and strict performance/KPI requirements.

Evaluation and validation of connected mobility in real open systems beyond 5GS



Coordinated by
Angelos Amditis, ICCS
January 2024 – December 2026

Website: envelope-project.eu

LinkedIn: www.linkedin.com/company/101531770/

Verticals concerned : CAM

Project Consortium Members:
ICCS, LINKS Foundation, NCSR D, University of Duisburg-Essen, TNO, Athena Research Centre, VICOMTECH, COSMOTE, KPN and TIM, Teoresi, ISFM, Hewlett Packard Enterprise, SIEMENS and LENOVO, Nextworks, FOGUS, Commsignia, Iquadrat, EBOS, InCites



SNS SOCIETAL CHALLENGES

*The three Streams of the call#2 are complemented
by the SNS Coordination and Support Action (CSA) 6G4Society
which aims at dealing with societal challenges
related to SNS technologies.*

6G4SOCIETY

Bridging Technology and Societal Values in 6G Development.

OVERVIEW

The 6G4Society project is a SNS phase 2 CSA that aims to address the tension existing between two parallel needs in terms of technological development of 6G: **securing technology performance objectives, while ensuring that societal and sustainability values are properly embedded into technology.**

The main objectives are:

- Generating a better understanding and shared knowledge on the aspects influencing public acceptance of 6G technologies.
- Supporting the conception and development of a unified EU consensus framework centred on a value-based, sustainable, and ethics-driven approach of 6G, promoting it throughout the European and international standardisation and regulation domains.
- Engaging and reaching out to public audiences to build 6G social acceptance, while engaging

technological players in accounting by design for equity, diversity, inclusion and sustainability.

- Empowering the 6G community to reflect EU policy and legislation in technology solutions for the development of future human-centred and sustainable networks and services.
- Acting as a hub within the 6G SNS community to help all ongoing projects to align on common societal and environmental priorities, Key Value Indicators (KVIs) and Key Sustainability Indicators (KSIs).

6G4Society engages various stakeholders in the 6G SNS ecosystem, including regulators, policymakers, and the public, to disseminate accurate information about the impact of 6G. The project reinforces Horizon Europe's commitment to innovation aligned with societal and environmental values. The consortium offers diverse expertise spanning technology, social sciences, communication, stakeholder engagement, sustainability, and policy.

Bridging Technology and Societal Values in 6G Development

6G4SOCIETY

Coordinated by Monique Calisti, Martel Innovate

January 2024 – December 2025

Website: www.6g4society.eu/

X: twitter.com/6g4society

LinkedIn: www.linkedin.com/company/6g4society/

Project Consortium Members:

Cyber Ethics Lab,
PSCE, NOVA, eBOS,
Martel, Digital
for Planet



CONCEPT/ METHODOLOGIES

The 6G4Society project aims at **providing and fostering a multidisciplinary and complementary perspective to future technological development.**

The project will apply methodologies from ethics, legal and social science and humanities (SSH) disciplines, allowing to comprehend socio-cultural aspects and mechanisms behind 6G technology and lay the foundation for responsible research and innovation (RRI) of 6G technology. Based on these methodologies, 6G4Society will provide frameworks, models, guidelines, policy suggestions and

operational recommendations to develop sustainable and socially accepted 6G technology and applications.

6G4Society will convey these complementary and multidisciplinary aspects operating on three main layers of action, interwoven throughout the comprehensive project work plan:

1. **Content.** Creating knowledge and providing advice on social and ethical thematic aspects relevant to 6G development, working especially on KVIs/KSIs, and on the definition of a Technology Acceptance Model.

2. **Processes.** Contributing to key innovation processes within the 6G ecosystems exploitation and up-take (such as engaging in standardisation discussions, project pilots, living labs, and working groups),

thereby channelling knowledge and multidisciplinary perspectives.

3. **Social Dynamics.** Addressing barriers and challenges related to the information and communication context through targeted communication and engagement activities.

USE CASES/ SCENARIOS

Being societal acceptance and environmental sustainability aspects essential for successful development and adoption of basically any technology, the work 6G4Society will undertake is of relevance across all verticals, possibly providing indications for 6G deployment across many different use cases and scenarios. By working in close coordination with

other ongoing 6G SNS projects, via for instance the 6G SNS Sustainability Task Force, but also within the context of the 6G SNS Vision, by participating in the Societal Needs and Value Creation sub-group (SNVC SG), the objective is to understand and advocate for the benefits 6G can provide to players on the market, including the society at large.



EXPECTED RESULTS

The 6G4Society planned results include a **Technology Acceptance Model tailored for 6G technology**, a **framework outlining Key Sustainability Indicators**, along with **policy and operational briefs**, providing recommendations to other players in the 6G SNS ecosystem and beyond. They will be validated with all SNS projects by adopting a public and user engagement methodology, alongside the 6G-IA Working Groups and their connected projects.

impacts, notably the **downstream exploitation of 6G**, the **ethical and sustainable development of 6G**, **larger public validation**, and **wider social acceptance**. Central to achieving these impacts is **increased awareness**, promoted across diverse stakeholder groups through various means and on different aspects depending on the issues and barriers addressed. This awareness, in turn, is expected to facilitate **openness and acceptance** across the different stakeholders, leading to the longer impacts mentioned above.

These efforts pave the way for wider scale and longer-term

SNS PROGRESS ASSESSMENT

The SNS programme to date

The SNS programme started in 2022 is organised in three main phases, as depicted in the figure below, with a first call for projects based on the first SNS Work Programme WP2021-22, then annual calls based on dedicated WPs.

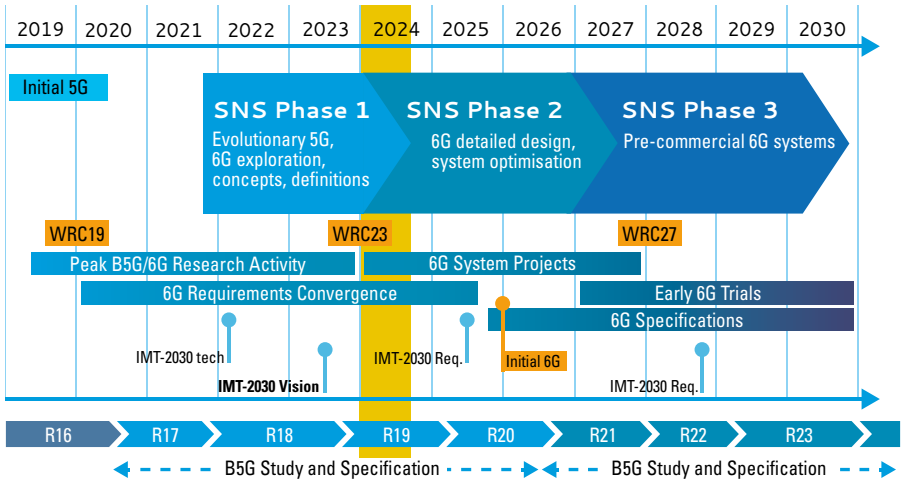

SNS Programme – Phased Approach

The SNS programme and its related projects are already step by step achieving outstanding progress and impact, as regularly highlighted in the SNS programme and projects websites and news^{1,2}. 63 projects are so far contractually active (35 projects in Call#1

and 28 projects in Call#2), ensuring an extremely high momentum and dynamism. 16 additional projects are expected to be contracted from Call#3 (projects to start in January 2025), as depicted in the figure below.

SNS Programme and Calls#1, #2 and #3 Projects

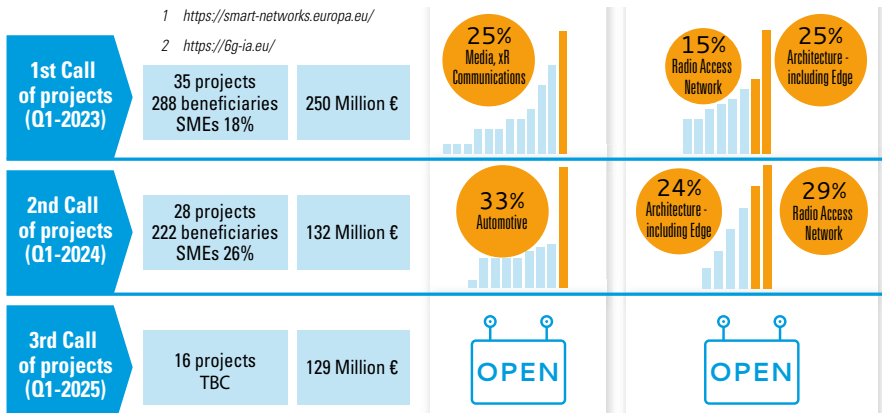

1 <https://smart-networks.europa.eu/>
2 <https://6g-ia.eu/>

Initial innovations and achievements

The previous Section of this SNS Journal highlighted the key information and achievements from the Call#1 project and the key information and objectives/plans from the Call#2 projects. As detailed in the next Section (SNS OPS Monitoring Framework), **the first SNS OPS programme questionnaire** allowed to rapidly define the first cartography of the SNS Call#1 projects on technical, vision and market perspectives and plans. The SNS Call#1 projects are now asked to provide their detailed inputs to **the next collection of data** addressing (not exhaustive list) the organised and contributed events (webinars, workshops, sessions, panels, keynotes), the co-authored and contributed peer-reviewed journal/magazine articles, conference papers, book chapters, White Papers, the standards contributions (from projects partners), the IPR (/ patents), the experimentations (proof of concept, lab tests, trials and pilots), the use of and contribution to open source... All the data collected will be analysed and consolidated by SNS OPS at programme level, including also for related further exploitation in SNS Steering Board (SB), Technology Board (TB) and overall SNS and 6G-IA Working Groups (WGs). Most SNS Call#1 projects already actively contribute to the SB, TB and different WGs. One of the key programmatic achievements is the SNS Projects Reference Cartography, currently developed by TB.

The 63 contracted projects step by step achieve significant technical and dissemination impact, directly at project level and at programmatic level, through cross-projects and WGs actions. The projects achievements have been detailed in the previous Section

of this SNS Journal. Concerning some key achievements at programme level, the following (non-exhaustive) list is already demonstrating the extremely high dynamism and momentum of the SNS programme (as also detailed in the SNS Newsflashes and Newsletters¹):

- **Activation and development of SB, TB and all SNS and 6G-IA WGs**, also including the setting-up of the SB Open Calls Task Force (including the Stream C and Stream D projects and targeting synergies and efficient implementation of the Open Calls) and the TB Sustainability Task Force (already including 14 projects addressing overall Sustainability in SNS).
- **Significant projects contributions to ETSI Research Conference 2023**².
- **Significant projects and programme contributions to EuCNC & 6GS 2023**³
- **Significant projects and programme contributions to international conferences** including 5G Techritory 2023, Global 5G Event 2023, Globecom 2023...
- **Several cross-projects workshops**, e.g. (among others) PREDICT-6G and DESIRE6G workshop at MobiHoc 2023⁴, TERRAMETA, TIMES 6G and 6G-SHINE workshop⁵ and Hexa-X-II 6G Series Virtual Workshops⁶ including SNS projects and international presentations from the different regions.

1 <https://smart-networks.europa.eu/sns-newsflash-newsletters/>

2 <https://www.etsi.org/events/2130-etsi-research-conference#pane-1/>

3 <https://www.eucnc.eu/2023/www.eucnc.eu/>

4 <https://desire6g.eu/6g-pdn-workshop-at-mobihoc2023/>

5 <https://terrameta-project.eu/joint-sns-workshop-times-6g-shine-terrameta-in-synergy-with-restart-in/>

6 <https://hexa-x-ii.eu/the-6g-series-workshop-by-hexa-x-ii-feb-2024/>

- **Development of the SNS Verticals engagement tracker**¹. visibility on partners/organisations booths and stands.
- **Strong SNS programme and projects contributions to MWC 2024**² including SNS Session (including among others Hexa-X-II Flagship project) and 20+ projects
- **Forthcoming programme and projects contribution to the 3GPP Stage 1 Workshop on IMT2030 Use-Cases**³.
- **Forthcoming significant projects and programme contributions to EuCNC & 6GS 2024**⁴.

1 <https://verticals-tracker.sns-ju.eu/>

2 <https://smart-networks.europa.eu/sns-ju-announces-its-flagship-event-on-6g-horizon-at-mobile-world-congress/>

3 <https://portal.3gpp.org/Meetings.aspx#/>

4 <https://www.eucnc.eu/>

Vision

EU stakeholders' vision for 6G was the impetus for the SNS JU programme's creation. This initial vision came to fruition through multiple contracted projects and the SNS JU community. The community's engagement and the natural separation of priorities, together with technological innovation, are helping to deepen understanding and fine tune the 6G vision. **The SNS OPS project has implemented several mechanisms to improve the vision over time**, namely:

- **The Network Europe Strategic Research Innovation Agenda (SRIA)**⁵ is released every two years with the entire community and stakeholders' involvement. SNS OPS supports and assists this development by contributing to Network Europe events and more.
- **The SNS OPS project's Monitoring Framework** to assess what the community and projects are working on and their respective visions.
- **The SNS OPS Vision retrospective assessment** based on current and previous Work Programmes.
- **SNS JU online webinars** which are used to provide status updates on the programme's development, and obtain informal feedback from the community.
- **Network Europe technical events**, supported by SNS OPS, and held regularly as sessions on technological challenges, to help build a community-wide vision of the future.

This is a cyclic community process, involving and affecting the community, as well as technical groups through the issued reports and results. The process also influences the drafting of future Work Programmes and thereby shapes the SNS JU overall. This is also a major source of input for the 6G-IA Board and the 6G-IA Vision and Societal Challenges WG (as well as the SNS projects Sustainability Task Force).

5 *Network Europe. Strategic Research and Innovation Agenda 2022.* <https://bscw.sns-ju.eu/pub/bscw.cgi/d95660/SRIA-2022-WP-Published.pdf>

6 *6G-IA White Paper: European Vision for the 6G Network Ecosystem – June 2021.* <https://5g-ppp.eu/wp-content/uploads/2021/06/WhitePaper-6G-Europe.pdf>

The Work Programmes and the SRIA focus are currently dominated by technology research and development. As result, the SNS Vision is expected to benefit from:

- **Increased focus on 5G and 6G enabled smart services**, business models and ecosystem evolution, including interoperable networks and services.
- **Looking beyond the typical 5G and 6G business opportunities**, social, environmental, and economic challenges and values must be addressed, mapping the relevant stakeholders in the extended ecosystems.

Both areas must galvanise the broader SNS JU community to reflect on reaching maturity and develop complementary roadmaps. One task will be researching and identifying industry bottlenecks and enablers and reconciling the two. The SNS community should also work to engage with other relevant communities.

Further actions should also be addressed by the relevant WGs, Subgroups, TFs, bodies, and SB and TB and related activities, for instance, to advance the vision in the aforementioned directions.

Cooperation and collaboration

The European Commission promotes international cooperation and seeks to reach a global consensus on the development of mobile standards and requirements, and especially on 5G and 6G. To this end, agreements have already been signed with many other regions around the globe to support 6G deployment and adoption.

The 6G Smart Networks and Services Industry Association (6G-IA) persistently and diligently engaged in the formalisation of other MoUs. These strategic partnerships and collaborations, marked by the signing of MoUs,

are indicative of 6G-IA's commitment to fostering strong relationships and alliances within the industry.

Twenty six Memoranda of Understanding (MoUs) and Letters of Interest/ Intent (LoI) with organisations and associations of strategic importance, including the Next G Alliance (USA), 5GForum (South Korea), the Beyond 5G Promotion Consortium (Japan), TSDSI (India), the NGMN Alliance, ESA, 5G-ACIA, AENEAS, 5G-MAG, Taiwan Association of Information and Communication Standards (TAICS), among others.

Targeted use cases

The identification of 6G use cases is key to predicting major trends in future usage scenarios, and will help to steer the needs and requirements for future generational change.

On November 18, 2023, the ITU-R reached an agreement on recommendations for the new “*IMT-2030 Framework*,” which sets the stage for activities such as 6G development, standardisation, and deployment. **In the ITU-R framework for IMT-2030, six “usage scenarios” are outlined**, three evolving from IMT-2020 and three introducing new capabilities. These scenarios include Immersive Communication, Hyper Reliable and Low-Latency Communication, Massive Communication, Ubiquitous Connectivity, Integrated AI and Communication, and Integrated Sensing and Communication. Each scenario is supported by four overarching aspects: sustainability, connecting the unconnected, ubiquitous intelligence, and security and resilience. These aspects serve as design principles embedded in all scenarios. Immersive Communication enables rich interactive video experiences, while Hyper Reliable and Low-Latency Communication caters to specialised use cases with stringent reliability and latency requirements. Massive Communication focuses on connecting numerous sensors and actuators, and Ubiquitous Connectivity aims to bridge the digital divide. Integrated AI and Communication emphasises distributed computing and AI-powered applications, while Integrated Sensing and Communication facilitates new services requiring sensing capabilities.

In Europe, Hexa-X-II has identified six use case families aiming to embrace the need for 6G. The families are: Immersive Experience, Collaborative Robots, Physical Awareness, Digital Twins, Fully Connected World, and Trusted Environments. For each family, a

representative use case was selected displaying the key aspects of that family. The six representative use cases have undergone a detailed analysis from which the requirements and KPIs that will guide the research in the subsequent project stages (e.g. designing phase) were extracted. While being inspired by the capabilities introduced in the IMT2030 Framework, the KPI analyses presented in this deliverable are use case-specific and emphasise the end-to-end performance aspects. Accordingly, further differentiation and refinement of capabilities as well as iterations with the Hexa-X-II design phase are required before definitive KPI values can be finally delivered.

In the US, the Next G Alliance Report sets out 6G Applications and Use Cases which include four categories of use cases: Network-Enabled Robotics and Autonomous Systems, Multisensory Extended Reality, Distributed Sensing and Communications, and Personalised User Experiences and fourteen related use cases: Online Cooperative Operation among a Group of Service Robots, Field Robots for hazardous environments, Ultra-realistic interactive Sport-Drone Racing, Immersive gaming/entertainment, Mixed reality Co-design, Mixed reality telepresence, Immersive education with 6G, High-speed wireless connection in aerial vehicle for entertainment service, Remote data collection, Untethered wearables and implants, Eliminating the North American digital divide, Public safety application, Synchronous data channels, and Healthcare in body networks.

The ‘Bharat 6G Vision’ document released in India led to the creation of a national mission for 6G with a nine-year tenure

(2022–2031). India defined eight use case categories/verticals, i) metaverse including digital twins, immersive reality and product design, media, entertainment and sports for immersive experiences, ii) education iii) quantum technology and integration with 6G iv) transportation and air mobility v) disaster management i.e. flood, air pollution, vi) defence and internal security vii) smart agriculture using 6G IoT and AI, and viii) healthcare with hospital-to-home and home-to-hospital services, connected ambulance services powered by AI, Intelligent wearable devices, tele-diagnosis and remote surgery as well as smart pharmacy box.

SNS projects address industry challenges

The industry faces a trifecta of challenges centred around Key Value (KV) and Key Value Indicators (KVI), sustainability, and cybersecurity. SNS projects are addressing these issues.

KEY VALUE INDICATORS/KEY PERFORMANCE INDICATORS (KVIS/KPIS)

Towards its end, the 5G PPP programme introduced KVIs as a concept to measure 6G's relation to and impact on key societal values. The first 6G Flagship project, Hexa-X¹, suggested a KVI development process. In parallel, the 6G-IA WG 'Vision and Societal Challenges' produced a White Paper on KVIs: '*What societal values will 6G address?*'², with examples from six use cases.

Despite which, the SNS community still does not fully grasp the concept of KVIs. In the **Monitoring Framework**, 1st Edition, the SNS OPS project surveyed the first SNS JU Call projects in the first half of 2023 (see page 181), also asking how projects

address KVIs³. From the responses it was clear that *Economical sustainability and innovation* were being addressed by many, while there was little emphasis on *Cultural connection, Personal freedom, Knowledge, and Simplified life*.

These findings underscore a shortfall in the social understanding of 6G implications, even when the motivation and will are there, within a research community focused predominantly on technical proficiency. This could be mitigated by greater participation from experts in **Social Sciences and the Humanities** (SSH) and thereby achieve a more nuanced development of KVIs grounded in subject matter expertise.

The lesson learned from this first SNS OPS survey is that projects, and

1 Hexa-X Deliverable D1.4: Hexa-X architecture for B5G/6G networks – final release. July 2023. <https://hexa-x.eu/wp-content/uploads/2023/07/Hexa-X-D1.4-Final.pdf>

2 6G-IA White Paper: What Societal values will 6G address? May 2022. <https://zenodo.org/records/6557534>

3 SNS OPS Deliverable D1.2: First Period Assessment and Planning Report. January 2024.

especially new ones, need a better introduction to KVIs. The second Edition of the Framework should therefore emphasise the KVI analysis process, instead of the KVIs themselves. KVIs are context dependent and created to measure the impact of 6G on relevant societal values for specific domains. There is also a need to establish links

between KPIs and KVIs. These aspects are expected to be further tackled by the ongoing work of the 6G-IA Vision WG and the Sustainability Task Force (TF). KVIs will thus be developed through processes such as expert consultation, user panels, simulation, measurement, and use case assessment.

SUSTAINABILITY

From the KVI investigations done by the SNS OPS project in 2023, it became clear that all SNS JU projects have grasped the importance of sustainability when researching and developing technologies and concepts for 6G. This was reflected in the 2nd SNS JU Work Programme (2023), where 'A reinforced emphasis on sustainability and social challenges' was included. Sustainability is also emphasised in the planned activities, the scientific priorities and challenges, and anchored in the **UN Sustainable Development Goals (SDG)**, particularly SDGs 8: *Decent Work and Economic Growth*, and 9: *Industry Innovation and Infrastructure*. To structure the approach to sustainability, the Hexa-X-II project defined three pillars¹:

- **Environmental sustainability:** power consumption and energy efficiency, decarbonisation, modular and durable equipment, circular economy adapted to communications technologies.
- **Social sustainability:** responsible, safe, and secure, as well as transparent digital ecosystem, involving trust and digital inclusion.
- **Economical sustainability:** stakeholders and ecosystems, including spectrum access.

For each of these pillars, there is a distinction between Sustainable 6G, and 6G for Sustainability. Sustainable 6G pertains to the development and deployment of 6G technology with sustainability principles ingrained throughout its lifecycle. 6G for Sustainability focuses on ICT as an enabler of sustainability across public and private economic sectors, such as health and transport.

¹ Hexa-X-II Deliverable D1.1: *Environmental, social, and economic drivers and goals for 6G*. June 2023. https://hexa-x-ii.eu/wp-content/uploads/2023/07/Hexa-X-II_D1.1_final-website.pdf

CYBERSECURITY

Secure 6G: A Strategic Necessity

6G cybersecurity is of strategic importance to the development and deployment of 6G infrastructures and services. Multiple factors demand consistent Research and Innovation efforts to tackle the evolving threat landscape, the unprecedented complexity and increased attack surface and the various policy frameworks.

Escalating Threats Require Robust Defences and Resilience

The cyber threats landscape is constantly evolving, with attacks growing in volume and sophistication. 6G networks, with their expanded attack surface and complex architectures, require robust defences encompassing physical layers, AI-powered systems, protecting both payload and control/management data and distributed network components. Beyond complexity, the systems' dynamics are also creating an imperative for cybersecurity operations to evolve towards the same

timescale for deployment, attack detection and remediation.

Policy Landscape and Challenges

Effective cybersecurity for 6G hinges on a collaborative approach between the cybersecurity and AI communities, cloud providers, and microelectronics industries. Key EU policies such as the Cyber Resilience Act and the NIS2 Directive lay down crucial cornerstones for securing 6G infrastructure. However, enabling 6G to reach its full potential also requires focusing on several key cybersecurity issues, including:

- **Convergence and Orchestrated Integration:** Seamless and secure convergence of network, cloud, and sensing technologies is critical. Establishing trust across different components and layers is essential for robust security protocols.
- **Adapting to Softwarisation and Cloudification:** The shift towards software-defined and cloud-based networks necessitates innovative security approaches such as Cross-domain monitoring and end-to-end security orchestration, with critical real-time threat identification and mitigation.
- **Secure AI for secure 6G:** The integration of secure AI and 6G for AI presents both opportunities and challenges. AI offers unparalleled capabilities for threat detection,

network optimisation, and automated responses. Potential vulnerabilities such as bias and adversarial attacks nevertheless demand robust monitoring systems and clear mechanisms for accountability and explainability.

- **Incorporating Crypto Technologies for Enhanced Security:** Cryptographic technologies like blockchain and post-quantum cryptography offer robust frameworks for securing communication and data privacy. Confidential computing and technologies are strong candidates for participating in Zero-Trust architectures and their evolution.
- **Security Knowledge Sharing and Deployment:** Effective security knowledge sharing, and deployment require overarching Cyber Threat Intelligence that is structured and organised to capitalise on the various sectors (technologies and usages). Finally, users should be informed of their digital services' security attributes, which implies highly ambitious advances in the evaluation, monitoring and exposition of security properties including the security-as-a-service paradigm.

The "6Gsec Common Path and Cardinal Points Conference" held in January 2024 brought together the European cybersecurity and SNS communities to discuss the state of the art of security.

Main recurring activities

SNS OPS MONITORING FRAMEWORK – 1ST EDITION (2023)

The SNS OPS Monitoring and Analysis Framework (defined in deliverable D1.1 of SNS OPS¹) aims to provide

a structured way to receive up to date information from the SNS projects and systematically process, analyse, compare, present and promote the highlights of the projects' work. To

¹ <https://smart-networks.europa.eu/csa-s/#SNS-OPS>

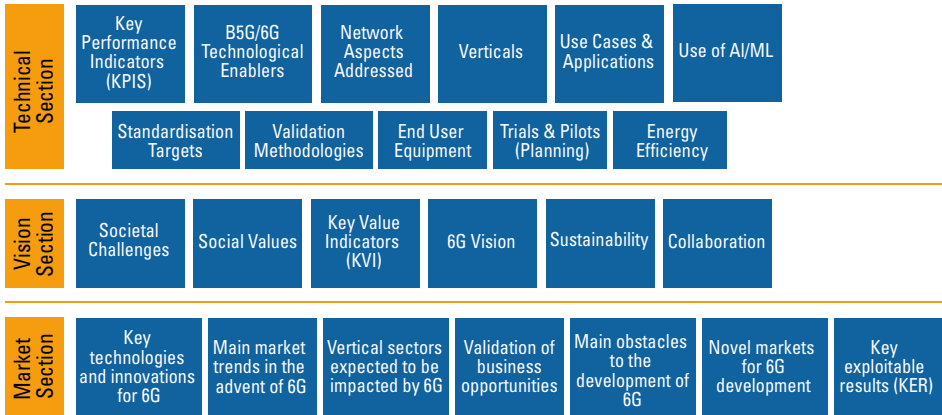

SNS OPS Framework (Questionnaire)
 – Sub-sections overview & addressed aspects.

accomplish that it uses an elaborate questionnaire targeted at SNS JU projects, in order to source critical information from the projects and to extract insights regarding the targeted technologies, use-cases and trials, the overall vision and the market aspirations of SNS projects.

More specifically the SNS OPS framework provides a standardised methodology, that the projects may use to communicate their achievements, work focus, vision, insights, and market aspirations, as well as a methodology to collect, process and report the findings of the analysis, based on the received input from the SNS JU projects. The framework also contains an approach to promote the insights gained by the analysis to all relevant stakeholders and a process to receive feedback from these stakeholders, which may in turn be used to update the next editions of the framework. The data collected from the projects, are processed, and generate knowledge and insights regarding:

- The current focus of work of each SNS project/stream.
- The ongoing work and addressed issues/challenges/use cases addressed by each project/stream.
- The targeted technical results from each project/stream.
- The technical aspects, technologies and KPIs for each project/stream.

- The 6G vision and relevant KVIs for each project/stream.
- The expected market impact based on the expected outcome of each project/stream.

The first edition of the SNS Framework (questionnaire) was issued in Q1 2023 comprised of 3 sub-sections, technical, vision and market, with a total of 29 questions (both multiple choice and open questions). An overview of the three sub-sections and the aspects addressed by each of them can be found in the figure. By mid-Q2 2023 the responses from all 33 Research and Innovation (R&I) projects of SNS JU Phase 1 had been received (35 projects in total in Phase 1 – the two CSA projects were not addressed).

The collected inputs were processed, and significant insights were gained with regards to the scope and focus of the SNS JU Phase 1 projects. This respective analysis allowed for a more in-depth knowledge and categorisation of the projects' work, which also assisted in the Gap Analysis process which is one of the factors driving the design of the follow-up Work Programmes (WP) of the SNS JU. This feedback loop guarantees that new or underserved technological or vertical areas will be addressed by follow up projects of the SNS JU, ensuring EU expertise and leadership in all relevant sectors.

The outcomes of the analysis and the respective insights of the first edition of the SNS OPS Questionnaire regarding Phase 1 projects are available in SNS OPS deliverable D1.21¹ and were presented to the community during a webinar on 23 November 2023. The key insights gained by section are summarised as follows:

Technical Insights

- Good coverage of all main KPIs by SNS Phase 1 projects (URLLC type KPIs & Energy Efficiency are the most popular).
- Stream C & D projects cover almost all main KPIs (offering them to experimenters)
- Good coverage of all major technologies targeted in Phase 1. The significant diversification observed can lead to cumulative and well-rounded insights, regarding these technologies.
- AI/ML is used as a global enabler within SNS Phase 1 projects (29/33 projects will use it) → Mostly targeting the network management & orchestration layer.
- Prominent use of Digital Twins across all streams.
- Stream-specific diverse verticals engagement → Reflecting stream priorities & focus.
- 3GPP and ETSI are by far the most targeted SDOs by SNS projects → targeting early-phase contributions in a broad selection of working groups.
- Sustainability issues are broadly addressed by Phase 1 projects.

Vision Insights

- Phase 1 projects indicate a clear focus on technology challenges followed by research, energy efficiency, and SME involvement.
- In terms of societal values projects focus mostly on sustainability and

energy consciousness followed by natively integrated AI and trusted technology challenges.

- The notion of KVIs and how to use them are still not 100% clear.
- Phase 1 projects showcase a focused vision towards EU leadership and standards contributions while also concerned about AI application and sovereignty and security.

Market Insights

- Market fragmentation versus rise of a few dominant industrial players, are two contradictory trends that arose from the project answers.
- The main market disrupters identified are Internet of Things, Digital Twins, Holographic technology, Internet of Senses, High Performance Computing and Quantum computing.
- AI-based solutions are expected to have the largest market impact followed by energy efficiency solutions and zero-touch network management solutions.
- The vertical sectors expected to be impacted the most by the advent of 6G are Industry 4.0, Media/xR, Automotive/Transport, Smart City and Smart Health.
- Phase 1 projects indicate deployment costs as the principal challenge for deploying 6G networks, followed by a potential lack of demand for unique 6G services.
- In terms of Technology Readiness, most Phase 1 projects target the delivery of solutions between TRL3 and 6, while stream D projects also aspire for TRL 7 solutions.

A second edition of the SNS OPS Framework (questionnaire) has been prepared for 2024 addressing both the ongoing Phase 1 projects and the new Phase 2 projects. A new section targeting the collection of data regarding the achievements of ongoing projects with regards to publications, contributions, events and more, has

¹ <https://smart-networks.europa.eu/csa-s/#SNS-OPS>

been added. The data collected from this section will assist in the population of SNS JU dissemination and

outreach metrics, and will provide a first indication of the achieved impact of the SNS JU projects.

SMALL AND MEDIUM ENTERPRISES' (SMEs) INVOLVEMENT AND SUCCESS STORIES

Small and Medium Enterprises (SMEs) are poised to play a significant role in shaping the landscape of 6G technology.

In 2023, the kick-off of the first SNS projects effectively marked the start of the work on 5G and 6G networks and services. The evolution of the SNS ecosystem, expanding into new verticals and complementary areas, has increased the involvement of SMEs, as well as that of other players. Representing 99% of all business in the EU, SMEs employ approximately 100 million people and account for over half of Europe's GDP. SMEs' ability to innovate make them critical actors in any value chain, including smart networks and services. Highlighting their expertise and competences are therefore crucial to ensuring that the best resources in the SNS ecosystem are leveraged to advance its mission to secure Europe's technological sovereignty in 6G and 5G deployment.

The NetworkEurope SME WG has continued to dedicate important efforts to promote the skills of its members within the SNS ecosystem, which in turn have showed a strong interest in helping to shape and deploy the SNS JU R&I roadmap.

The SMEs' involvement in the SNS JU has surged in just a short time. While SMEs accounted for 18% of stakeholders who responded to the 2022 SNS call for projects, this figure increased to 27% in the 2023 SNS CFP, surpassing the 20% SME participation recommended by SNS JU. This increase is also reflected in the growing number of SMEs affiliated with 6G-IA and the NetworkEurope SME WG across the whole of Europe.

The "European SME expertise in 5G and beyond 2023" brochure released

in February 2024 is one of the central instruments for promoting SMEs. In addition to 81 company descriptions, the brochure contains a compilation of success stories about SMEs in the WG, showcasing their accomplishments in the 5G PPP and SNS projects.

Accelleran, a Belgian company based in Antwerp, is successfully providing its dRAX Open RAN components and solutions to many Horizon Europe projects, including BeGreen, SEASON and DESIRE-6G in SNS.

In the 5G HEART and 5G TOURS projects, **ACTA Ltd** (Greece) installed network monitoring probes and a cloud-based management system for measuring 5G network performance KPIs such as throughput, latency, jitter, loss, availability, reliability, and E2E, as well as in segments of the network (radio vs. core, physical vs. service layer, E2E vs. segments of interest to the operator).

A leading company in advanced wireless communications, **Azcom Technology** (Italy) has been actively involved in the Horizon Framework since 2015. One of the many highlights is Azcom's contribution to the Connected Car PoC in the 5G CORAL project, where 5G CORAL technologies, functions application and services, can be run on the vehicles, in the On-Board Unit (OBU) and on the Roadside Unit (RSU).

Cognnin is the only Greek SME in the "Important Project of Common European Interest in Microelectronics and Communication Technologies" (IPCEI ME/CT). Involved in the "Communicate- systems for fast, secure and reliable transmission of information" workstream, Cognnin will develop beyond 5G activities and

edge computing RAN technologies for several new 6G use cases.

The deployment of private mobile networks for commercial Points of Sales (PoP) at outdoor events such as concerts and festivals by **Cumucore OY** was one of the finalists for the 2023 Global Mobile (GLOMO) Award at the Mobile World Congress 2023. The Finnish SME also delivered private 5G with network slicing to the International Space Station (ISS).

Cyberethics Lab's developed a novel Responsible Research & Innovation (RRI) approach and holistic assessment framework, which combines qualitative and quantitative tools and methods, to ensure compliance with the EU regulation and ethics, and to evaluate the social acceptance of disruptive technology. As part of the IMPULSE project, the Italian SME designed and developed innovative smart software, integrating cutting-edge technologies such as smart contracts and blockchain, for the management and control of personal data consent mechanisms.

Based in Cyprus, **eBOS** participates in various SNS projects, namely: ADROIT6G, where the company provides its 5G/IoT testbed facility and expertise to facilitate the testing and validation of the extreme 6G use cases in the PoCs in small-scale lab environments; RIGOUROUS, where it leads the implementation of an AI-driven decision-making mitigation framework; and, FIDAL, where it will contribute to the development of AI as-a-service for secure and intelligent experimentation

IMST's cutting-edge lens technology was recognised by the 2023 EuCAP Best Applied Technology Antenna Paper Award in the EU CAP2023. In this paper, the German SME shows how to build high-gain, low-loss, low-reflection lenses for sub-THz radar applications using 3D printing technology.

Partaking in various 5G PPP and SNS projects, **INFOLYSIS** specialises in

the innovative design and development of cutting-edge chatbot applications for several key industries. In the EVOLVED-5G project, the Athens-based SME developed a Chatbot Assistance system that facilitates the handling of machinery maintenance scenarios, with the help of the Network Applications.

Focusing on delivering a "new generation of research tools for system level evaluation of wireless integrated communication systems", **Iquadrat** has extensive know-how in 5G/6G communication platforms, IoT platforms, and Demand Response algorithms for the Smart Grid. The Spanish SME coordinates two 5G PPP projects: MARSAL and 5G-MEDIAHUB.

In addition to various H2020 projects, **Montimage** is participating in the SNS project DETERMINISTIC6G. The French SME provides a complete network Monitoring and Security Management Framework (MMT) and developed 5Greplay, an open source solution for 5G network traffic replay and conducting scalability, performance, and robustness tests on the different 5G network elements.

Nearby Computing (Spain) is part of several EC-funded research projects on a diverse ecosystem of innovative use cases, including smart grid, automotive or affordable 5G private networks. Its work on zero-touch network and service management, developed in the Affordable5G, 5GMED and Smart5Grid projects, was singled out by European Commission's Innovation Radar.

In the context of 5G-EPICENTRE, **Nemergent Solutions** (Spain) contributed to the creation of an trial platform where SMEs and start-ups can perform agile and simple 5G trials before addressing their transition to 5G/6G broadband networks. Some 10 SMEs have tested the platform that will now be offered to third parties, bringing 5G technologies closer to European SMEs and start-ups,

especially to those involved in PPDR and blue lights services.

RFSAT Limited, based in Ireland, is active in the area of high precision GNSS positioning. As part of the AgriBIT project, funded by H2020 in collaboration with EUSPA, it has developed a pre-commercial high-performance integrated GNSS, tested for monitoring crops. The device is currently being evaluated in the context of Smart and Sustainable Agricultural applications in Italy, Greece, and Portugal.

An active player in the 5G/6G R&I ecosystem, **TRUST-IT** participates in initiatives such as 6Gstart, SNS ICE, and SNS OPS. The Italian SME's main contributions span vertical engagement mapping, pre-standardisation gap analyses, as well as online platforms such as the Verticals Cartography

(with over 250 use cases mapped), and the Standards Tracker.

The WINGS STARLIT digital health and wellness platform will be deployed in Nea Filadelfeia/Nea Chalkidona (Greece). The solution developed by **WINGS- ICT** (Greece) will enable the municipality's citizens to have their health and wellness monitored remotely, while being able to remain at home. STARLIT is a cloud-based platform powered by AI/ML, IoT and advanced wireless networks, secure and compliant with legacy regulations.

These success stories illustrate SMEs' deep involvement in the SNS JU and the SNS projects and how they are driving innovation, but also SNS projects' impact on the development of many SMEs products, solutions, and services.

SCODIHNET ACTIVITIES AND REPLICABILITY TOOL

The Smart Connectivity Digital Innovation Hub Network (SCoDIHNet) aims to connect the SNS JU with end users through Digital Innovation Hubs (DIHs), which are designed to facilitate the European industry's digitalisation. These DIHs receive support from the Digital Europe programme and focus on seeking out innovative solutions that can be deployed in various industries.

It serves as a platform for disseminating and sharing advancements in SNS JU projects, and for gathering requirements from end-user industries to ensure that future 6G networks can accommodate them.

In 2023, SCoDIHNet carried out various activities. The key highlights are summarised below:

Smart Connectivity Technology providers mapping with DIHs

A mapping of Smart Connectivity Technology providers with DIHs has been developed to facilitate the new collaborations at the local level between end users and technology providers. Stakeholders, particularly SMEs

who are members of AIOTI, 6G-IA, NetworkEurope, the 5G Community CEF, and GAIA-X Hubs, have been identified (over 600 organisations) and located at the regional level to identify potential collaborations among stakeholders in the same area. DIHs implemented at the regional level can easily access the most relevant Smart Connectivity Expertise in their area.

Cooperation with the CEF 5G for Smart Community projects

The objective of 5G for Smart Community projects is to establish and manage private 5G networks in public buildings such as government offices, schools, hospitals, and for cities. These 5G infrastructures aim to create use cases that leverage the capabilities of 5G.

Since DIHs are also creating innovative services utilising 5G, the collaboration involves opening these 5G infrastructure to local DIHs. This facilitates the development of new use cases for public services.

Cooperation with African DIHs

A collaboration is underway with five EU-funded projects aimed at developing Digital Innovation Hubs (DIHs) in Africa with the goals of sharing best practices and promoting European Smart Connectivity technologies.

On 23 February 2023, a workshop was held with African DIHs alongside DIH4AI. The main outcomes addressed the following points: a) Sharing the list of DIHs from each organisation (SCoDIHNet, DIH4AI, AEDIB|NET, AfriconEU, Hubiquitous, Make, Digilogic); b) Identifying the key verticals covered by DIHs; c) Identifying the key technologies used by African DIHs; d) Building a catalogue of training courses for sharing; e) Organising a webinar on Replicability for African DIHs; f) Planning a workshop with presentations on the journey of European and African DIHs.

These activities have commenced, and some have already been completed, involving 66 DIHs operating in 20 African countries.

Replicability initiative

A tool for assessing replicability and scalability has been designed and developed in collaboration with AIOTI. This tool aims to provide a replicability level for use cases and solutions developed by smart connectivity projects. Two workshops took place, one in June and one in October of last year, to elucidate the initiative's objectives and the methodology employed to run the projects. One workshop was dedicated to AIOTI projects, while the other targeted 5G PPP and SNS JU projects.

6GStart has gathered numerous use cases developed and trialled by 5G PPP phase 3 projects, while SNS OPS has done the same for SNS JU Call 1 projects. These use cases and solutions will contribute to the Replicability catalogue, which already contains over 1,000 entries from AIOTI projects, 5G PPP projects and NGI projects.

Cooperation with other thematic DIHs sub-networks

SCoDIHNet serves as the thematic sub-network focusing on the area of Smart Connectivity, while there are several others covering different digital domains such as AI, cybersecurity, HPC, Manufacturing, Agriculture, CPS, robotics, etc., supported by various European partnerships. The collaboration led by SCoDIHNet aims to share best practices and align the service offerings for DIHs. Meetings were held with DG CONNECT/A4 to introduce the initiative, which was warmly received as a complementary effort to the Digital Transformation Accelerator, supporting the daily activities of the EDIHs.

Cooperation with the European Startup Nation Alliance (ESNA)

SCoDIHNet has received an invitation to apply for membership on the advisory board of the ESNA. This initiative aims to establish a connection between startups and DIHs at the local level. ESNA endeavours to harmonise startup support across European member states, and this presents an opportunity to engage with regional representatives who have direct contact with local startups.

SCoDIHNet service platform

To bolster the functioning of DIHs, 18 services have been identified and are accessible through two platforms: the Collabwith platform, operated by AIOTI, and the DIHWare platform operated by Eurescom.

The Collabwith platform provides services that facilitate collaboration among stakeholders, while DIHWare offers a marketplace featuring various catalogues developed by SCoDIHNet.

SCoDIHNet becomes a sub-group of the Trial WG

SCoDIHNet was established through a joint effort by the 6G IA and AIOTI. It has been affiliated with the AIOTI Innovation WG since its inception, and a proposal was made recently to the

6G-IA board to integrate SCoDIHNet into the Trials WG. A presentation of SCoDIHNet was made at the Trials WG plenary meeting on September 4, 2023. This served as a first step, to inform and engage 6G-IA members in collaborating with DIHs.

Cooperation with the Enterprise Europe Network (EEN)

The cooperation that began in 2022 has been reignited after a meeting with the new Chairman. The most pressing action item is to map SCoDIHNet members with EEN members to facilitate cooperation at the local level. The newly appointed staff of the EEN

Digital group is already deeply engaged with DIHs, so this collaboration is expected to take on a new dimension. The goal is to expand this cooperation to include other Thematic Sub-Networks, thereby encompassing a wider array of digital domains. [SCoDIHNet foreseen activities in 2024](#)

In 2024, the primary activities will include updating the SCoDIHNet membership, selecting key services for sharing with other sub-networks, utilising the replicability assessment tool with the SNS JU Call#1 projects for the 35 identified use cases, and continuing collaboration with other organisations.

Other 6G initiatives

This past year has been rich in events, cooperation agreements, workshops, and White Papers. This section provides a global overview and reports on major milestones.

MAJOR EVENTS

The previous months have been eventful.

Global 5G event 2023

The global 5G events serve as a significant platform for sharing the latest trends in 5G achievements and discussing various topics related to mobile communication, global unified B5G technology standards, and industrial ecosystems. The events also cover discussions on 6G issues, in addition to 5G.

The 10th edition was held in South Korea, on 30 and 31 October 2023. Over the course of one and half days, six sessions were conducted, focusing on Regional Policies for 5G/6G, 5G Business Model and Monetisation, Evolution of 5G device and solutions,

5G+6G-Evolution of 5G Network towards 6G, Future service, technology, and socio-economic trends for 6G. A total of 29 invited speakers delivered excellent presentations during these sessions. Furthermore, a special session on 5G specialised Network and applications in Korea was hosted by KT, LG Electronics, and ETRI.

Europe was represented by pre-recorded video presentations from Peter Stuckmann, DG Connect, Emanuel Dotaro SNS OPS and Thales, and Hanne-Stine Hallingby, SNS OPS and Telenor and Alex Kaloxylou, 6G-IA in person.

EuCNC 2023

The 2023 EuCNC & 6G Summit was an exciting event that combined the highly successful EuCNC and 6G Summit conferences. It took place from June 6th to 9th in the city of Gothenburg, Sweden, and served as a hub for telecommunications professionals from around the world. Supported by the European Commission and sponsored by prestigious organisations such as IEEE ComSoc, EURASIP, and EurAAP, the summit covered a wide range of telecom topics, from 5G deployment to future communications systems and networks. The event attracted renowned industry experts, cutting-edge researchers, more than 1,300 delegates from over 40 countries and more than 70 exhibitors. It featured engaging presentations, enlightening discussions, and a technology exhibition that showcased innovations from EU R&I projects.

The 2024 edition of the EuCNC is held in Antwerp, Belgium from 3 to 6 June 2024.

In 2023, many 5G PPP and SNS projects had a booth including 5G-BLUEPRINT, 5G-EPICENTRE, 5GMediaHUB, 5G-STARBUCKS, 5G-VICTORI, 6G-BRAINS, 6G-BRICKS, ARIADNE, DAEMON, DEDICAT6G, FIDAL, HEXA-X and HEXA-X-II, MARSAL, TRIALSNET, TERAWAY, TERAFLUX, 5GRAIL. 5G-ROUTES and 5GMED held a joint booth.

On Day 1, the “6G series workshop by HEXA-X and HEXA-X-II” session was hosted by Colin Willcock, Chairman of the Board of the Smart Networks and Service Joint Undertaking and 6G-IA Chair. He presented a “European Vision for 6G networks” and explained why “6G is that critical component to finally tackle the societal challenges of our time”.

The same day, ETHER, 6G-NTN, 6G-SANDBOX, and 5G-STARBUCKS presented their projects at the “Aligning European NTN Convergence and Integration” session, which also provided an overview on how the various

initiatives can all contribute to a coherent strategy to achieve NTN/TN convergence in Europe.

The “Empowering Transatlantic Platforms for 5G Advanced and 6G Network” workshop moderated by Serge Fdida, Professor at the Sorbonne Université, featured a presentation from SNS Phase 1 Stream C projects platforms and targeted use-cases by Kostas Trichias, from the 6G-IA and SNS ICE Project Coordinator.

Other compelling workshops included “Exploring the Intersection of 6G and AI: Unleashing the Potential of Next-Gen Technologies” as well as “Measuring societal value impact in 6G with KVIs”. This last workshop organised by Gustav Wikström from Ericsson Research engaged the audience in useful discussions. KVIs is now a rather well established concept used by many, albeit without really knowing what it means or how to make use of it.

In his opening session of Day 2, Pearse O’Donohue, from DGConnect, emphasised the importance of hardwiring the development of 6G technologies with European values. He was joined on stage by Magnus Frodigh, Vice President & Head of Research, Ericsson; Håkan Eriksson, First Deputy Lord Mayor Gothenburg; and Lead Organiser Tommy Svensson (Chalmers University of Technology).

David Kennedy, from Eurescom, led the conversation on “5G PPP – The value generated for Europe”, discussing how to identify common trends, the importance of collaboration activities and the proposal on forthcoming SNS WGs. He was joined on stage by Colin Willcock (6G-IA), Dan Warren (Network Research at Samsung), Didier Bourse (European R&I Programmes at Nokia), Peter Stuckmann (SNS JU at that time), Pavlos Fournogerakis (DGConnect at the time) and Alexandros Kaloxylou (6G-IA).

Chiara Mazzone from the SNS JU Office, discussed Sustainability and

how “*Science-based evidence is crucial to support policymakers in adopting green digital solutions*”.

She was also a keynote speaker at the WiTaR session “*Women in Telecommunication and Research*” expressing that “the sector needs to do more for female representation across the industry” and sharing her thoughts on how this can be enabled. The session proved a catalyst for the audience to join this initiative and contribute to change.

On Day 3, Pavlos Fournogerakis and Colin Willcock of 6G-IA kicked off the session “*SNS: A European collaborative initiative with a strong vertical impact on a global level*”, during which they explained key strategic objectives, the importance of the adoption of the results at European level, as well as the different streams and the 35 SNS JU Phase 1 projects which started in January 2023.

The session transitioned into an engaging panel discussion, deftly chaired by Konstantinos Trichias from 6G-IA. This discussion provided a comprehensive exploration of the various activities currently unfolding at the European level, encompassing both national initiatives and HEU Partnerships, as well as delving into the perspectives and involvement of vertical users. The dialogue offered insightful views on the progression and impact of these

activities within the broader scope of European technological advancement.

Colin Willcock also spearheaded the session on “*The Path to 6G Standardisation*”, emphasising the importance of incorporating the outcomes of 6G SNS projects into standardisation, a fundamental aspect of the 6G SNS mission that should be considered from the outset. The subsequent panel discussion featured a distinguished guest: Bernard Barani, Senior consultant at the 6G-IA, formerly of DGConnect.

Pernilla Bergmark, Principal Researcher for ICT Sustainability Impacts at Ericsson, provided a detailed and insightful presentation on the expectations for a sustainable 6G network. Her discussion emphasised the importance of implementing stricter frameworks for sustainability communication. She also highlighted the need for a more decentralised and load-adaptive electricity grid, which is essential for managing energy consumption more efficiently. Bergmark brought attention as well to the increasing focus on the impacts of materials used in network infrastructure, stressing the need for environmentally friendly choices. She further underscored how crucial it is to consider the social impact of 6G technology, ensuring that its development and deployment are aligned with societal needs and contribute positively to communities.

MWC2024

The Mobile World Congress, or MWC, is considered the most significant international summit for the mobile connectivity industry, and held annually in Barcelona, Spain. The presence of SNS JU and SNS projects underscore their commitment to advancing cutting-edge technologies and fostering collaboration within the telecommunications industry. Over 80,000 people attended the 2024 edition of the event.

6G Horizon session

The “*6G Horizon*” session was hosted by the SNS JU, aimed at exploring the

next frontier of wireless communication technology: 6G. The imperative to examine the potential of next-generation communications from various perspectives led to the organisation of the 90-minute session titled “*Bridging Perspectives for a Sustainable Future*.”

The session explored the multifaceted case for 6G, recognising the diverse views brought to the table by multiple stakeholders. The conference served as a pivotal platform to promote understanding and alignment of these varied perspectives. The interaction among industry leaders, innovators,

policymakers, and researchers propelled the collective vision of what 6G could and should entail.

The distinct European perspective on 6G was explored during the session, highlighting the continent's strong tradition of public-private collaboration that has shaped its technological landscape. The essential connections between 6G and various vertical industries were highlighted, paving the way for transformative applications and services.

Moreover, the discussion underscored 6G's significant impact on crucial areas such as sustainability and cybersecurity. As society progresses towards a more interconnected and data-driven future, 6G stands poised to revolutionise approaches to forthcoming challenges, offering innovative solutions for resource optimisation and data sovereignty.

MWC also attracted a host of SNS projects.

- Keysight Technologies hosted at the MCW 2024 in collaboration with the partners NVIDIA and InterDigital, at the booth 5E12 to promote 2 demo stands from the SNS JU project 6G-SANDBOX and CENTRIC Project.
- 5G-STARBUCK was at SRS, Orange, Hispasat, Thales and CTTC booths.
- ADROIT 6G, 6G-BRICKS, INTENSE-6G and SUNRISE-6G were present through Iquadrat's stand.
- 6G-XR shared the booths of i2Cat, Telefonica, Matsuko, CapGemini and InterDigital (IDE).
- TARGET-X was at Neutroon's stand.

- PREDICT-6G and 6G-SHINE were present at InterDigital's (IDE) booth.
- VERGE project was at NBC's and CTTC's booths.
- HEXA-X-II was present both on Nokia's and Ericsson's stands.
- 6G-NTN was at Greener Wave's stand.
- 6GREEN made presence at the stands of HPE Italy, Orange Romania and Telenor
- 6G-EWOC was at UPC's booth.
- OPTI-6G was present at RunEL's stand.
- 6G-CLOUD was at BubbleRAN's booth.
- FirstTo6G made presence at stands of InCirt, Sivers Semiconductors and Argo Semiconductors.
- 6G-XCEL was present at Juniper's booth.
- 6G-REFERENCE was at CTTC's stand.
- 6G-TWIN made presence at Viavi solutions' and Acceleran's booths.

The *"Enablement for Connected Vehicles Workshop"* took place on the morning of the 28 February 2024, organised by Network Europe and CCSA. It was a hybrid event with online and onsite participants. The workshop provided an open information space sharing current and future views about the connected vehicles, and how this topic is being addressed by different stakeholders. Two different panel discussions were held, focusing on challenges and progress, new use cases and technology trends as well as standardisation and next step industry developments for connected vehicles.

OTHER PAST EVENTS AND INITIATIVES

Workshops and webinars

Major workshops took place in 2023 and early 2024. Some of them are listed here.

Impact Assessment and Facilitation Actions (IAFA)

These events are part of a series of actions within the scope of SNS OPS CSA targeting relevant partnerships, initiatives and associations to raise awareness about the work of the SNS JU and its projects.

IAFA event 1: Digital Innovation Hubs (DIH), to strengthen knowledge exchange with the SNS community

The first IAFA event, Digital Innovation Hubs (DIH), to strengthen knowledge exchange with the SNS community and collaboration event, took place online on Thursday, 5 October 2023.

The DIH aims to facilitate the digitalisation of European industry in the context of the Digital Europe Programme. SCoDIHNet (Smart Connectivity Digital Innovation Hub Network) is a network of DIHs with expertise in Smart Connectivity (5G/6G, IoT, Security). DIHs aim to develop the links between end users (industry) and technology providers, of which SNS JU projects are considered key sources. To this end, various initiatives are being developed focusing on replicability, mapping of technology providers and end-user requirements. The replicability initiative aims to facilitate the reuse of use cases/solutions developed by SNS projects by compiling them in a regularly updated catalogue from which DIHs can pick up use cases and solutions that fit their customers. The mapping initiative aims to map all technology providers, testbeds and DIHs at the regional level to foster cooperation among stakeholders working in the same region, thereby facilitating innovation development with end-user customers. Lastly, end-user requirements are being collected to feed the SNS RIA and work plan, as DIHs are very close to end users.

More than 150 people registered, representing mainly SNS JU projects. Of those, some 42 participants attended the event. In particular, 34.2% of the participants were from the industry, 18.4% from an RDTI organisation, and 15.8% from academia. The remaining participants came from DIHs, public authorities and other sectors. Most participants were based in Spain, Belgium, Greece and Switzerland. They were interested in better understanding the complementary aspects of research projects and DIHs – and were therefore particularly interested in the replicability initiative that showed them a way to accelerate market application of project results.

Several projects voiced their interest in joining SCoDIHNet and in maintaining contact in order to contribute to the replicability catalogue with their use cases. When SNS JU projects start to develop use cases and trial them, further investigations will help qualify the level of replicability.

After the event, a report was produced at <https://smart-networks.europa.eu/first-iafa-report/> and published with Zenodo (<https://zenodo.org/records/10040220>). A recording of the event was uploaded to the SNS YouTube channel.

IAFA event 2: Connectivity and micro-electronics

The event was part of the WP4 series of IAFAs, which are research-based activities targeting relevant Partnerships, Initiatives and Associations to raise awareness about the SNS initiative and its work, and to gather feedback from them on how they see their future using our technology. Twenty six experts from varied backgrounds – including the industrial sector, policy makers and EU association representatives – participated in the event.

Participants presented their organisation's involvement in HEU funded R&I activities, their opinion on what is still missing and their vision on topics related to micro-electronics and connectivity. There was a roundtable with open discussions understand the current state of affairs propose directions for future R&I WPs for the SNS and Chips Jus. Further action points were identified to elaborate on these topics and provide additional information on specific topics (e.g., their views on visualisation). The outcome of this process will be a short paper with suggestions that will be submitted for consideration to the SNS JU GB and the Chips JU GB.

Twenty four topics were identified as promising in the area of microelectronics for 6G, and discussions on next steps for each of them have begun with stakeholders.

This was a closed event with targeted experts. P2P invitations were sent to the participating experts. No public promotion was required.

IIFA event 3: The 6Gsec Common Path and Cardinal Points "6Gsec (CP)"²

The "*6Gsec Common Path and Cardinal Points Conference*" brought together the European cybersecurity and Smart Networks and Services (SNS) communities to discuss the state of the art of the security domain.

Organised by SNS-OPS, ECSO and NetworldEurope and hosted by INRIA, the "*6Gsec Common Path and Cardinal Points Conference*" took place on the 23 of January 2024 at the Campus Cyber in Paris, France. It brought together close to 100 researchers, practitioners, policymakers and enthusiasts ready to delve into the future of cybersecurity in the 6G era.

Hosted by Emmanuel Dotaro (Thales) and Roberto Cascella (European Cyber Security Organisation, ECSO), the day started with the keynote "*SNS Network of the Future*" (Thomas Orazio, France 6G), presenting the package of actions and initiatives envisioned by the French government to tackle SNS security.

A comprehensive overview of the current policy landscape was provided by Matteo Mole (ECSO), laying the foundation for the rich discussions that followed. Rui Aguiar (Chair of NetworldEurope) and Fabio Martinelli (Chair of WG 6 at ECSO) discussed the update of both SRIAs, emphasising the need for collaborative efforts to address the emerging cybersecurity challenges. Apostolos Malatras (ENISA) closed the first part of the agenda with a presentation that dissected the threat landscape, providing valuable insights into current and emerging cybersecurity threats. The afternoon was dedicated to technical discussions on the security architecture and distribution in 6G; secure AI for secure 6G; crypto-based technologies application in 6G; and security knowledge and deployment. The animated interactions among the panellists and a very vocal and engaged audience led to many meaningful exchanges.

The event closed with the session "*Paving the way for common roadmaps engaging both communities*". Pavlos Fournogerakis (SNS JU Office), Miguel Gonzalez-Sancho (DG-CNECT, Interim director of ECCC), Fabio Martinelli (IIT CNR), and Rui Aguiar (IT Aveiro) underlined the need to cooperate and build common roadmaps for the future, emphasising the shared responsibility in shaping a resilient and secure digital landscape.

The event served as a testimony to the importance of a strong collaboration to address the complex challenges of cybersecurity in Europe and marked the start of a long cooperation ahead.

IEEE International Conference on Network Softwarisation

The theme of the IEEE NetSoft 2023 “*Boosting Future Networks through Advanced Softwarisation*” reflects the vision that future networks will also integrate a native service dimension in a compute-connectivity continuum environment encompassing different network segments / providers / domains and enabled by softwarisation coupled with new advanced architectures, frameworks, and models. This will allow greater flexibility, reliability, adaptability, and efficiency for both network operations and service deployments for the benefit of an ecosystem of different application

layers/developers/components. This will also lay the foundation to move beyond the current inter-networking capabilities in Future Internet architectures and to further convergence between internetworking and IP layer re-engineering. Around 150 participants attended. More information about the event can be found on the website: <https://netsoft2023.ieee-netsoft.org/>. Rui Aguiar (ITAV) participated as a speaker and member of the distinguished expert panel. The event helped to disseminate of ideas coming from NetworldEurope SRIA.

Berlin 6G conference

The Berlin 6G Conference was the annual networking event of the German 6G Programme, organised by the 6G Platform Germany and co-located with the 2nd Germany-Japan Beyond 5G/6G Research Workshop. The event took place at the Berlin Congress Centre from 26-29 June 2023. The event provided an excellent opportunity to learn about the latest in German 6G projects, EU and other national 6G programmes, and engage in insightful discussions on key trends and technologies. The event attracted

over 600 registrations, with good participation from industry, academia and government representatives.

The event was important in better aligning national and European level 6G research activities. At the lowest level, both sides need to be aware of the ongoing activities and future plans, but beyond this, it is hoped that offline discussions with government representative responsible for national 6G research programme funding will lead to more concrete alignment on future research activities.

5G TECTRITORY

The 5G TECTRITORY has become a major event on the connectivity conference calendar. 5G TECTRITORY 2023 attracted 1,667 participants from 77 countries and 146 speakers. It featured the signature of two Memorandums of Understanding, 18 co-creation events focusing on 5G practicalities, and 32 excellent panel and keynote speeches. It combined a strong industrial and academic presence with many administration participants. There was good participation from the Baltic region and, more broadly, from major European countries.

On 18 October 2023, the SNS OPS team led by 6G-IA organised the panel entitled “*Why 6G? the need for the next generation Smart Networks and*

Services and lessons learned from previous generations” which was moderated by Colin Willcock, Chairman of the Board, 6G-IA, with some 80 people attending in person and many more live streaming the event.

The world of telecoms is gearing up for 6G, the next generation of mobile networks expected by 2030. Promising more than just telecommunications, 6G aims to incorporate features like sensing and massive IoT, ushering in Smart Networks and Services (SNS). This raises questions about the actual need for 6G – is it solving a real market gap, or is it a solution in search of a problem? The SNS OPS partner 6G-IA organised a panel of experts from various telecom sectors, to explore

these questions, considering diverse stakeholder needs, problems requiring 6G solutions, potential pitfalls, and

lessons from previous network generations.

The SNS JU brokerage event

The SNS Research & Innovation Work Programme for 2024 was distributed at the official opening of the 2024 call that took place on 16 January 2024. The submission deadline will be 5 pm (Brussels local time) on 18 April 2024. The SNS JU Brokerage Event was designed to allow any organisation in the wider SNS JU community to present their organisation profile and/or interests to their peers – as an introduction for possible future collaboration(s). To further assist stakeholders to form

competitive proposal consortia, the SNS JU Brokerage Platform has also been made available. Any organisation can post its expertise or proposal ideas on the platform, and of course browse the information posted by other stakeholders.

There were 138 registrations for the event. There were many presentations in each of the streams: Stream A – 14 presentations; Stream B – 14 presentations; Stream C – 10 presentations; Stream D – 13 presentations.

Hexa-X-II workshop “Enablers for 6G system blueprint workshop”.

On January 26, 2024, a dedicated workshop was organised by Hexa-X-II together with many 6GSNS Phase 1 projects, DETERMINISTIC6G, DESIRE6G, FLEX-SCALE, 6G-NTN, TERRAMETA, TIMES, RIGOROUS, and HORSE.

The workshop went into the details of 6G architecture and provided a view on the standardisation process towards 6G.

The 6G series workshop by Hexa-X-II (June 2023 and February 2024)

Hexa-X-II and other European projects from 5G PPP ICT-52 and SNS JU organised a second global and fully virtual workshop open to all on February 13-14, 2024. It followed a first version organised by Hexa-x which took place in June 2023.

The 6Gseries workshop was supported by the European Commission and the SNS JU Office. In addition to insights from the 6G view, perspectives from other SNS projects, as well as 6G German research projects, were covered. The workshop aimed to provide valuable insights and stimulate thoughtful discussions, enriched by perspectives from various world regions. The workshop attracted more than 100 people.

WHITE PAPERS AND REPORTS

In 2023, several White Papers and reports were produced by projects, by the 6G-IA and by 6G-IA WGs. All White Papers are publicly accessible via the 5G PPP website¹ or the 6G-IA website. An overview is provided below.

- **The ATIS/SNS White Paper “Beyond 5G/6G Roadmap”²** was released in December 2023 and is available for download on the 6G-IA website.

This document contains a set of critical strategic reflections and recommendations for 6G networks and services, capturing the views and priorities from Next G Alliance and the SNS JU. This document proposes a roadmap for future opportunities through EU and US funding instruments. It also aims to provide directions for collaboration opportunities that will go beyond the scope of such funding instruments, assisting the academic and business stakeholders between the two sides of the Atlantic to identify mutually beneficial opportunities.

- In September 2023, the 6G-IA published **a position paper on key strategies for 6G Smart Networks and Services**³. This paper presents a set of key strategic reflections and recommendations for 6G smart networks and services, capturing the views and priorities from the members of the 6G-IA. This document will be used to further elaborate future versions of the SNS JU Strategic Research and Innovation Agenda (SRIA) as well as the R&I Work Programmes. It also offers directions for collaboration opportunities for European Stakeholders that go beyond the scope of the SNS JU.

- **The “Technologies & Standards to Enable Vertical Ecosystem Transformation in 6G” White Paper⁴** was published by Networld Europe in July 2023. The White Paper focuses on the enabling technologies in the 6G era and their transformative impact on the society, the economy, and the environment, with a strong focus on current and emerging vertical sectors. It then outlines the key standards and enabling technologies that are driving the transformation of vertical ecosystems, such as network slicing, virtualisation, AI, and edge computing. Finally, the summary highlights the challenges and opportunities associated with this transformation, as well as the potential impact of 6G on the digital economy.

- **The “Towards Sustainable and Trustworthy 6G – Challenges, enablers and architectural design” White Paper** was released on June 2023 in the continuation of the 5G PPP Test, Measurement and Validation WG entitled *“Beyond 5G/5G KPIs and Target Values”*.

The intention of this White Paper is to provide an analysis of the nature of the beyond 5G/6G KPIs identified in the previous White Paper, by further elaborating on the feasibility of these KPIs to be measured, on the methods and tools to be used for their evaluation, and on identifying challenges encountered, gaps identified and research steps to be followed on the measurement and evaluation methodologies to be used in the 6G era. Capitalising on the 5G Public-Private-Partnership (5G PPP) Phase 3 projects and the joint efforts between the Architecture WG and the flagship Hexa-X project, this book delves into the critical challenges

1 <https://5g-ppp.eu/white-papers/>

2 [eu-us-aligned-6g-roadmap-joint-paper.pdf \(6g-ia.eu\)](#)

3 [6g-ia-position-paper_2023_final.pdf](#)

4 [White Paper1_WG_Enabling_Technologies_final.pdf \(5g-ppp.eu\)](#)

and enablers of the 6G system, including new network architectures and novel enhancements as well as the role of regulators, network operators, industry players, application developers, and end-users. Accordingly, this paper provides a comprehensive overview of the current research activities on 6G and sets a solid cornerstone towards a more connected, intelligent, and sustainable world. It is available free of charge directly from the publisher¹.

- **The “Innovation trends in I4.0 enabled by 5G and Beyond Networks” White Paper**² was released by the 5G PPP Technology Board in October 2023. It offers a comprehensive view of Industry 4.0 (I4.0) design principles, driven by collaboration between I4.0 leaders and contributors to 5G development. It also assesses the applicability of 5G for short and mid-term I4.0 challenges based on input from stakeholders. The report touches on evolving 5G technologies, like Deterministic Networking and Digital Twinning, and explores the future of ecosystem dynamics, regulation, and sustainability. Ultimately, it provides valuable insights into the synergy between I4.0 and 5G, drawing from leading 5G PPP Phase III projects.
- **The “Network Applications: Opening up 5G and Beyond Networks” White Paper**³ was published in July 2023 by the 5G PPP Software Network WG and ICT-41 projects. Network Application is seen as a full-potential enabler for future vertical industries beyond current deployment. It must therefore be considered along with other 6G enabling

technologies in the next-generation network architecture. This paper focuses on the different technical aspects of Network Application, new business models for all stakeholders, experimental facilities to support Network Application, and new Network Intelligence (NI) solutions that can be enabled by using Network Application. This White Paper is the second published by the Software Network WG and it goes into the implementation details of the two major Network Applications: “aaS” and hybrid models.

- **The “Beyond 5G/6G EMF considerations” White Paper**⁴ was made publicly available on the 5G PPP website in July 2023 by the 5G PPP Test, Measurement and KPIs Validation WG and EMF Task Force. It provides an overview of electromagnetic field (EMF) exposure issues related to wireless communications and in particular to beyond 5G and 6G systems. The relevant standards and effects are summarised; additionally, ideas on what and how to measure EMF effects are put forward as a springboard for further discussion and research. The available KPIs from the 5G PPP phase III projects with a focus on EMF are also consolidated with a view of how the KPIs are considered in the 5G system and how they may evolve in 6G systems.

¹ *now publishers - Towards Sustainable and Trustworthy 6G: Challenges, Enablers, and Architectural Design*

² *Innovation-Trends-in-I4.0-enabled-by-5G-and-Beyond-Networks.pdf (5g-ppp.eu)*

³ *Software-Network-Network-Applications-Version-2.0-JULY-2023-updated.pdf (5g-ppp.eu)*

⁴ *EMF-TF-white-paper_v1.2_.pdf (5g-ppp.eu)*

Appendices

Working Groups

As part of the SNS JU Governance mode, three types of WGs have been formed to address certain issues and publish consolidated views established within the SNS Community: i) SNS Industry Working Groups (6G-IA WGs), established under a mandate from the 6G-IA, ii) SNS JU Project Working Groups (SNS JU WGs), established under the mandate of the inter-project SB and iii) SNS Strategic Working Groups (SNS GB WGs) established under the mandate of the SNS JU Governing Board (GB).

Other WGs work under the mandate of NetworkEurope.

WGS AND LEADERS	ORIGIN
6G Architecture Ömer Bulakci, Nokia Xi Li, NEC Lab	SNS JU
5G/6G for Connected and Automated Mobility (CAM) Jesus Alonso-Zarate, i2CAT Markus Dillinger, Huawei	6G-IA
Pre-Standardisation Ricardo Trivisonno, Huawei Claudio De Majo, Trust-IT	6G-IA
Spectrum Giovanna D'Aria, Telecom Italia	6G-IA
Security Pascal Bisson, Thalès Antonio Skarmeta, University of Murcia	6G-IA
Trials Carles Antón-Haro, CTTC	6G-IA
Vision and Societal Challenges Artur Hecker, Huawei Håkon Lønsethagen, Telenor	6G-IA
Open Smart Networks and Services Aitor Garcia Vinas, Vodafone	6G-IA
Reliable Software Networks David Artuñedo, TID	SNS JU
Test, Measurement and KPIs Validation Michael Dieudonne, Keysight Technologies	SNS JU
Women in Telecommunication and Research (WiTaR) Bahare Masood Khorsandi, Nokia Marie-Hélène Hamon, Orange	6G-IA
SatCom Tomaso de Cola, German Aerospace Centre DLR	NetworkEurope
SME Jessica Carneiro, Australo Nicola Ciulli, Nextworks	NetworkEurope
Enabling Technologies for Future Vertical Ecosystem Transformation Prof. Maziar Nekowee, University of Sussex Dr. Xulei An, Huawei European Research Centre	NetworkEurope
Verticals Task Force Raffaele De Peppe, Telecom Italia	6G-IA
Expert Advisory Group Ari Pouttu, University of Oulu Jyrki Huusko, VTT	NetworkEurope

Acronyms and abbreviations

3D three-dimensional	E2E End-to-end	KPI/KV/ Key Performance	RTO Radio Transmission
5G 5th Generation Wireless Systems	EAS Edge Application Service	KVI Indicator/Key Value/Key Value Indicator	RO Operator
5G PPP 5G Public Private Partnership	Edge4AI edge for AI	LoI Letter of Intent	RU Radio Unit
5GS 5G System	eFBB Enhanced Fibre Broadband	M&O Management & Orchestration	SatCom Satellite communication
6G 6th Generation Wireless Systems	eMBB enhanced mobile broadband	M2MP point-to-multipoint	SB Steering Board
6G-IA 6G Smart Networks and Services Industry Association	ETSI European Telecommunications Standards Institute	MAC medium access control	SBA Service-Based Architecture
ABS Anti-lock Braking System	EU European Union	MAS Managed Access System	S-BVTs sliceable Bandwidth Variable Transceiver
ADAS Advanced Driver-Assisted Systems	FFBC Full Fibre Broadband Connection	MB Multi Band	SCoDIHNet Smart Connectivity Digital Innovation Hub Network
AI/ Artificial Intelligence/ AI4Edge/ AI for edge/AI-native	FFC Full Fibre Connection	MBoSDM Multi Band over Space Division Multiplexing	SDM Space Division Multiplexing
AI-AI/ Air Interface/Artificial	FFGRB Full Fibre Guaranteed Reliable Broadband	MEC Multi-Access Edge Computing	SDN Software Defined Network
AIML Intelligence/Machine Learning	FHE Fully Homomorphic Encryption	MIMO Multiple-Input Multiple-Output	SDO Standard Development Organisation
AP Access point	FL Federated Learning	ML Machine Learning	SME Small and medium-sized enterprise
API Application programming interface	FPGA Field Programmable Gate Array	mMIMO Massive MIMO	SMPC Secure Multi-Party Computation
AR Augmented Reality	GEO Geosynchronous Earth Orbit	mMTC massive Machine-Type Communication	SNS/ Smart Networks and Services/SNS Joint Undertaking
ASIC Application-specific Integrated Circuit	NGSO/ Geosynchronous Equatorial Orbit/	mmWave Millimetre wave	SNS JU Smart Networks and Services/SNS Joint Undertaking
BSG Beyond 5G	LEO Non Geosynchronous Equatorial Orbit/Low Geostationary Earth Orbit	ms millisecond	SPT4AI Secure, Private and Trustworthy AI
BICMOS Bipolar Complementary Metal-Oxide Semi-Conductor	GHG Greenhouse Gas	NBI Northbound Interface	TB Technology Board
B-RAN blockchain RAN	GHz Gigahertz	NGSO Non-geostationary	TEE Trusted Execution Environment
BS Base station	gNB next Generation Node B	NIC Interface Card	THz Terahertz
CapEx Capital Expenditure	GPU Graphics Processing Unit	NOS Network Operating System	TN/NTN Terrestrial Network/ Non-Terrestrial Network
CoMP Coordinated Multipoint	GRE Guaranteed Reliable Experience	NTN Non-Terrestrial Networks	TRL Technology readiness level
CSAs Coordination and Support Actions	GRFB Guaranteed Reliable Fibre Broadband	O/E/O Optical to Electrical to Optical	UAV Unmanned aerial vehicle
CORENect European Core Technologies for future connectivity systems and components CORENect	GRFFE Guaranteed Reliable Full Fibre Experience	ON Optical Node	UC Use Case
CPS Cyber Physical Systems	HAP(S) High Altitude Platform (Station)	Open RAN Open Radio Access Network	UI User Interface
CPU Central Processing Unit	HPC High Performance Computing	OpEx Operating Expense	UN United Nations
CU Centralised Unit	HPC High Performance Computing	P2MP Point-to-MultiPoint	UP User Plane
D2D Device-to-Device	IAFA Impact Assessment and Facilitation Actions	P2P point-to-point	UPF User Plane Function
DaaS Desktop as-a-Service	ICT Information and Communication Technology	PHY physical layer	URLLC low-latency communications
DDoS Distributed Denial of Service	IIoT Industrial Internet of Things	PoC Proof of Concept	V2V, vehicle-to-vehicle
DIDs Decentralised Identifiers	IoT Internet of Things	PON Passive Optical Networks	VC verifiable credentials
DIH Digital Innovation Hub	ISAC Instance-specific Algorithm Configuration	QO Quasi-Optical	VIM Virtual Infrastructure Manager
DIMO Distributed Intent-Driven Management and Orchestration	ITU/ITU-R International Telecommunication Union/ITU Radiocommunication sector	QoE Quality of Experience	VNF/NF Virtual network function/ Network Function
DLT Distributed Ledger Technology	J Joules	R&D Research and Development	VR Virtual reality
DPD Digital Predistortion	JCAS Joint Communications And Sensing	RAN Radio Access Network	vRAN virtualised RAN
DPU Data Processing Unit	KCL King's College London	rApps robotic Applications	WBSS Wave Band Selective Switch
DSA Decarbonisation Service Agreement		Rel. Release	xAI Explainable Artificial Intelligence
DSP Digital Signal Processing		RF Radio Frequency	xApps Cross Applications ()
DU Distributed Unit		RIS Reconfigurable Intelligent Surfaces	XR extended reality
		RRM Radio Resource Management	ZSM Zero-touch network and Service Management
		RRM Radio Resource Management	
		RSU radio-side unit	
		RT RIC Real-Time RAN Intelligent Controller	

Printed in May 2024
DÉFI NUMÉRIQUE, Montpellier



This report contains material which is the copyright of certain SNS OPS Consortium Parties and may not be reproduced or copied without permission.

All SNS OPS Consortium Parties have agreed to publication of this report, the content of which is licensed under a Creative Commons Attribution-NonCommercial-NoDerivs 4.0 Unported License .

Neither the SNS OPS Consortium Parties nor the European Commission warrant that the information contained in the Deliverable is capable of use, or that use of the information is free from risk and accept no liability for loss or damage suffered by any person using the information.



CC BY-NC-ND 4.0 License – 2024 SNS OPS Consortium Parties

SNS JOURNAL/2024

This material has been designed and printed with support from the SNS OPS project and the 6G Infrastructure association.

The SNS OPS Project has received funding by the European Union's Horizon Europe HORIZON-JU-SNS-2022-STREAM-CSA-01 under grant agreement number 101095811.

The European Commission support for the production of this publication does not constitute endorsement of the contents, which reflects the views only of the authors, and the Commission cannot be held responsible for any use which may be made of the information contained therein.

6G SNS

More information at
<https://smart-networks.europa.eu>



Supported by the

